

MAX2550

Band I, V, and VIII WCDMA Femtocell Transceiver with GSM Monitoring

General Description

The MAX2550 is a complete single-chip RF-to-bits and bits-to-RF radio transceiver. This device is in compliance with the 3GPP TS25.104 femtocell standard for Band I, V, and VIII. It is equipped with multiple receive inputs and transmit outputs for low band, high band, and macro-cell monitoring (Table 1).

This fully integrated transceiver facilitates compact radio designs for dongle and standalone femtocell products by minimizing external component count. Maxim's MAX-PHY serial interface is used to drastically reduce IC pin count, while worldwide field-proven architecture accelerates time to product deployment.

The device features unparalleled receive blocker performance and the industry's lowest noise figure for higher data rates and range. Low-power operational modes are available to minimize power consumption. The transmitter is designed to deliver EVM far exceeding the standard requirement at 0dBm.

The MAX2550–MAX2553 is a family of pin-compatible transceivers that cover all major WCDMA and cdma2000® bands. All parts are controlled by a 4-wire interface.

The MAX2550 is packaged in a compact 7mm x 7mm TQFN and specified over the -40°C to +85°C extended temperature range. A complete radio reference design is available to facilitate custom designs.

Applications

WCDMA Band I, V, and VIII Femtocells

Ordering Information and **Simplified Block Diagram** appear at end of data sheet.

For related parts and recommended products to use with this part, refer to www.maxim-ic.com/MAX2550.related.

cdma2000 is a registered service mark of Telecommunications Industry Association.

Benefits and Features

- ◆ Single-Chip Femtocell Radio Transceiver
- ◆ WCDMA/HSPA+ Band I, V, and VIII Operation
- ◆ TS25.104 Standard Compliant
- ◆ Multiple LNA Inputs for WCDMA, PCS, and GSM Macrocell Monitoring
- ◆ High Level of Integration
 - ◇ On-Chip Fractional-N Frequency Synthesizers for LO Generation
 - ◇ No Tx SAW Filters Required
 - ◇ Integrated PA Drivers for Lower-Cost Power Amplifier Designs
 - ◇ 12-Bit AFC DAC to Control TCXO
 - ◇ On-Chip Temperature Sensor
 - ◇ Three General-Purpose Outputs
 - ◇ Reference Clock with Selectable CMOS and Low Swing Output
 - ◇ PLL Lock-Detect Output Through GPO3
- ◆ Optimized Receiver Performance
 - ◇ Exceptional Receive Sensitivity
 - ◇ High Dynamic Range Sigma-Delta ADCs Allow Simple AGC Implementation with Switched Gain States
- ◆ Optimized Transmitter Performance
 - ◇ Factory Calibrated for Gain, Carrier Leakage, and Sideband Suppression
 - ◇ 10-Bit Gain Control Resolution for Better Power Accuracy
 - ◇ 60dB Gain Control Range
- ◆ Loopback Operating Mode from Tx Baseband Input to Rx Baseband Output
- ◆ MAX-PHY Serial Digital Interface
- ◆ SPI Read/Write Functionality
- ◆ Operation Controlled by 4-Wire Serial Interface
- ◆ Low-Cost, 7mm x 7mm TQFN Package

For pricing, delivery, and ordering information, please contact Maxim Direct at 1-888-629-4642, or visit Maxim's website at www.maximintegrated.com.

MAX2550

Band I, V, and VIII WCDMA Femtocell Transceiver with GSM Monitoring

ABSOLUTE MAXIMUM RATINGS

V _{CC_} to GND_	-0.3V to +3.9V	Junction Temperature	+150°C
RXIN_, MIXIN_, LNAOUT_ to GND_	-0.3V to +1.2V	Operating Temperature Range	-40°C to +85°C
All Pins except V _{CC_} to GND_	-0.3V to (V _{CC_} + 0.3V)	Storage Temperature Range	-65°C to +150°C
AC Input Signals	1.0V Peak	Lead Temperature (soldering, 10s)	+300°C
Digital Input Current	±10mA	Soldering Temperature (reflow)	+260°C
Maximum VSWR Without Damage	8:1		
Continuous Power Dissipation (T _A = +70°C)			
TQFN Multilayer Board			
(derate 40mW/°C above +70°C)	3.2W		

Stresses beyond those listed under "Absolute Maximum Ratings" may cause permanent damage to the device. These are stress ratings only, and functional operation of the device at these or any other conditions beyond those indicated in the operational sections of the specifications is not implied. Exposure to absolute maximum rating conditions for extended periods may affect device reliability.

PACKAGE THERMAL CHARACTERISTICS (Note 1)

TQFN	Junction-to-Ambient Thermal Resistance (θ _{JA})	25°C/W	Junction-to-Case Thermal Resistance (θ _{JC})	1°C/W
------	---	--------	--	-------

Note 1: Package thermal resistances were obtained using the method described in JEDEC specification JESD51-7, using a four-layer board. For detailed information on package thermal considerations, refer to www.maxim-ic.com/thermal-tutorial.

DC ELECTRICAL CHARACTERISTICS

(V_{CC_} = 3.0V to 3.6V, T_A = -40 to +85°C, 50Ω system, f_{REFIN} = 19.2MHz, typical values are at V_{CC_} = 3.3V, T_A = +25°C, unless otherwise noted. Register settings as defined in tables following the specification tables.) (Note 2)

SPEC NO.	PARAMETER	SYMBOL	CONDITIONS	MIN	TYP	MAX	UNITS
DC1a	Supply Voltage	V _{CC_}		3.0	3.3	3.6	V
DC19a	Operating Supply Current WCDMA	I _{CC_}	Full-duplex high band		298	390	mA
DC19b			Full-duplex low band		300	390	
DC20			RXIN2 monitor		78	105	
DC21			RXIN4 monitor		78	105	
DC22			RXIN5 monitor		72	95	
DC23			Tx only		236	315	
DC24			Idle Rx		43		
DC25			Idle Tx		40		
DC3	Operating Supply Current AFC-Only Mode	I _{CC_}	AFC DAC and SPI only		175	1000	μA
DC5	Operating Supply Current Reference Buffer Mode	I _{CC_}	REFOUT = 500Ω 22pF, all else = off		5.3	7.5	mA
DC6	Operating Supply Current Sleep Mode	I _{CC_}	All functions off		14	1000	μA
DC11	Digital Input Logic-High			1.3			V
DC12	Digital Input Logic-Low					0.4	V
DC13	Input Current for Digital Control Pins					10	μA
DC16	GPO Sink Current		V _{OUT} = 0.35V, DOUT_DRV = 01	1.0	1.8		mA
DC17	GPO Source Current		V _{OUT} = V _{CC_} - 0.3V, DOUT_DRV = 01	1.0	1.9		mA

MAX2550

Band I, V, and VIII WCDMA Femtocell Transceiver with GSM Monitoring

AC ELECTRICAL CHARACTERISTICS

(MAX2550 EV kit, $T_A = -40^{\circ}\text{C}$ to $+85^{\circ}\text{C}$, registers set as described in Tables 20–51, $V_{CC_} = 3.0\text{V}$ to 3.6V , $f_{\text{REFIN}} = 19.2\text{MHz}$, all sensitivity levels and blocker levels are antenna referred. Typical values are at $V_{CC_} = 3.3\text{V}$, $T_A = +25^{\circ}\text{C}$ and mid-band, unless otherwise noted. Tx specifications are referred to the input pin of the chip.) (Note 2)

Band I Duplexer Specifications

(Duplexer between antenna and duplexer loss: 0.3dB (applies to all Rx modes).)

Antenna—Uplink Port (Applies to Uplink WCDMA Rx Mode on RXIN1)

BAND (MHz)	Uplink 1920 to 1980	1 to 1870	1870 to 1920	1980 to 2020	2020 to 2200	2300 to 2500	2500 to 4500	4500 to 12750
ATTENUATION (dB)	Attenuation	Minimum Attenuation						
	2	32	12	12	37	27	12	7
Rx SAW FILTER RESPONSE								
BAND (MHz)	Out of band							
ATTENUATION (dB)	Required minimum attenuation relative to in-band							
	25							

Band I Uplink WCDMA Rx Mode on RXIN1 (Full Duplex)

SPEC NO.	PARAMETER	CONDITIONS	MIN	TYP	MAX	UNITS
Wb1fu-0	Frequency Band	WCDMA FDD Band I uplink (lowest to highest channel center frequency)	1922.4		1977.6	MHz
Wb1fu-1	Sensitivity 3GPP TS25.104 Section 7.2.1	Tx on at -27dBm, LNA gain mid gain, PGA gain register set to 9, assumed SNDR > -17.5dB at sensitivity, using UL reference measurement channel (12.2kbps) as specified in A.2 3GPP 25.104, tested by measurement of SNDR at output on CW input signal at -90dBm, SNDR at MAX-PHY filter output established with FFT, LNA linearity set to high		-116	-107	dBm
Wb1fu-1a	Sensitivity with LNA in High-Gain Mode	Tx on at -27dBm, LNA gain high, PGA gain register set to 6, assumed SNDR > -17.5dB at sensitivity, using UL reference measurement channel (12.2kbps) as specified in A.2 3GPP 25.104, tested by measurement of SNDR at output on CW input signal at -90dBm, SNDR at MAX-PHY filter output established with FFT, LNA linearity set to high		-119	-107	dBm
Wb1fu-3	High-Level EVM WCDMA	$P_{\text{IN}} = -20\text{dBm}$, LNA gain low, PGA gain register set to 1		4.5		%

MAX2550

Band I, V, and VIII WCDMA Femtocell Transceiver with GSM Monitoring

AC ELECTRICAL CHARACTERISTICS (continued)

(MAX2550 EV kit, $T_A = -40^{\circ}\text{C}$ to $+85^{\circ}\text{C}$, registers set as described in Tables 20–51, $V_{CC-} = 3.0\text{V}$ to 3.6V , $f_{REFIN} = 19.2\text{MHz}$, all sensitivity levels and blocker levels are antenna referred. Typical values are at $V_{CC-} = 3.3\text{V}$, $T_A = +25^{\circ}\text{C}$ and mid-band, unless otherwise noted. Tx specifications are referred to the input pin of the chip.) (Note 2)

Band I Uplink WCDMA Rx Mode on RXIN1 (Full Duplex) (continued)

SPEC NO.	PARAMETER	CONDITIONS	MIN	TYP	MAX	UNITS
Wb1fu-4	Sensitivity with Adjacent Channel Interference 3GPPP TS25.104 Section 7.4.1	Tx on -27dBm, LNA gain high, PGA gain register set to 3, assumed SNDR > -17.5dB at sensitivity, inferring signals at front-end input -28dBm, at 5MHz offset and -5MHz offset and modulated as in 3GPP. Using UL reference measurement channel (12.2kbps) as specified in A.2 3GPP 25.104. Production tested by measurement if SNDR at output on CW input signal at -90dBm. SNDR at MAX-PHY filter output established with FFT.		-109	-101	dBm
Wb1fu-5	Sensitivity with In-Band Blocking Interference 3GPPP TS25.104 Section 7.5.1	Tx on -27dBm, LNA gain high, PGA gain register set to 6, assumed SNDR > -17.5dB at sensitivity, inferring signals at front-end input -30dBm, at 10MHz offset and -5MHz offset and modulated as in 3GPP. Using UL reference measurement channel (12.2kbps) as specified in A.2 3GPP 25.104. Production tested by measurement if SNDR at output on CW input signal at -90dBm test only worst case in production. SNDR at MAX-PHY filter output established with FFT.		-117	-101	dBm
Wb1fu-6	Sensitivity with Out-of-Band Blocking Interference 3GPP TS25.104 Section 7.5.1	Front-end assumed response as above, Tx on at -27dBm, LNA high gain, PGA gain register set to 6, assumed SNDR > -17.5dB at sensitivity, interfering signal at front-end input -15dBm CW, 1MHz to 1900MHz and 2000MHz to 12750MHz using UL reference measurement channel (12.2kbps) as specified in A.2 3GPP 25.104, tested by measurement of SNDR at output on CW input signal at -90dBm, SNDR at MAX-PHY filter output established with FFT (Note 3)		-112	-101	dBm

MAX2550

Band I, V, and VIII WCDMA Femtocell Transceiver with GSM Monitoring

AC ELECTRICAL CHARACTERISTICS (continued)

(MAX2550 EV kit, $T_A = -40^{\circ}\text{C}$ to $+85^{\circ}\text{C}$, registers set as described in Tables 20–51, $V_{CC_} = 3.0\text{V}$ to 3.6V , $f_{\text{REFIN}} = 19.2\text{MHz}$, all sensitivity levels and blocker levels are antenna referred. Typical values are at $V_{CC_} = 3.3\text{V}$, $T_A = +25^{\circ}\text{C}$ and mid-band, unless otherwise noted. Tx specifications are referred to the input pin of the chip.) (Note 2)

Band I Uplink WCDMA Rx Mode on RXIN1 (Full Duplex) (continued)

SPEC NO.	PARAMETER	CONDITIONS	MIN	TYP	MAX	UNITS
Wb1fu-8	Sensitivity with Intermodulation Interference 3GPP TS25.104 Section 7.6.1	Tx on at -27dBm; LNA gain high; PGA gain register set to 6; assumed SNDR > -17.5dB at sensitivity; interfering signals at front-end input -38dBm, at 10MHz offset (CW) and 20MHz offset (modulated) as in 3GPP; using UL reference measurement channel (12.2kbps) as specified in A.2 3GPP 25.104; tested by measurement of SNDR at output on CW input signal at -90dBm; SNDR at MAX-PHY filter output established with FFT (Note 3)		-118	-101	dBm
Wb1fu-10	Spurious Emissions Out-of-Band 3GPP TS25.104 Section 7.7.1	30MHz to 1GHz, measured in 100kHz BW		-100	-60	dBm
		1GHz to 12.75GHz, measured in 1MHz BW, with the exception of frequencies between 12.5MHz below the first carrier frequency and 12.5MHz above the last carrier frequency used by the BS (Note 3)		-75	-50	
Wb1fu-11	Spurious Emissions in Receive Bands 3GPP TS25.104 Section 7.9.2	Front-end assumed response as above, 1920MHz to 1980MHz (Note 3)		-95	-80	dBm
Wb1fu-12	Conversion Gain High LNA Gain	LNA high gain; PGA gain register set to 6; tested on CW input signal at -90dBm; calculated by subtracting the FE input signal in dBm from the ADC output signal in dBFS at digital filter outputs, includes digital gain to the 16-bit output	21	30	36	dB
Wb1fu-13	Conversion Gain Mid LNA Gain	LNA mid gain; PGA gain register set to 9; tested on CW input signal at -90dBm; calculated by subtracting the FE input signal in dBm from the ADC output signal in dBFS at digital filter outputs, includes digital gain to the 16-bit output	21	30	36	dB
Wb1fu-14	Conversion Gain Low LNA Gain	LNA gain low; PGA gain register set to 1; tested on CW input signal at -20dBm; calculated by subtracting the FE input signal in dBm from the ADC output signal in dBFS at digital filter outputs, includes digital gain to the 16-bit output	-13	-7	-3.5	dB

MAX2550

Band I, V, and VIII WCDMA Femtocell Transceiver with GSM Monitoring

AC ELECTRICAL CHARACTERISTICS (continued)

(MAX2550 EV kit, $T_A = -40^{\circ}\text{C}$ to $+85^{\circ}\text{C}$, registers set as described in Tables 20–51, $V_{CC-} = 3.0\text{V}$ to 3.6V , $f_{\text{REFIN}} = 19.2\text{MHz}$, all sensitivity levels and blocker levels are antenna referred. Typical values are at $V_{CC-} = 3.3\text{V}$, $T_A = +25^{\circ}\text{C}$ and mid-band, unless otherwise noted. Tx specifications are referred to the input pin of the chip.) (Note 2)

Antenna—Downlink Port (Applies to Downlink WCDMA Rx Mode on RXIN5)

BAND (MHz)	Downlink 2110 to 2170	1 to 2025	2025 to 2050	2050 to 2095	2185 to 2230	2230 to 2255	2255 to 12750
ATTENUATION (dB)	Attenuation	Minimum Attenuation					
	2	15	10	0	0	10	15

Band I Downlink WCDMA Rx Mode on RXIN5 (Monitor)

SPEC NO.	PARAMETER	CONDITIONS	MIN	TYP	MAX	UNITS
Wb1fd-0	Frequency Band		2112.4		2167.6	MHz
Wb1fd-1	Sensitivity 3GPP TS25.101 Section 7.3.1	LNA gain high, PGA gain register set to 11, assumed SNDR > -7dB at sensitivity, using UL reference measurement channel, (12.2kbps) as specified in C.3.1 3GPP 25.101, tested by measurement of SNDR at output on CW input signal at -90dBm, SNDR at MAX-PHY filter output established with FFT, LNA linearity set to high		-110		dBm
Wb1fd-4	Sensitivity with Adjacent Channel Interference 3GPP TS25.101 Section 7.5.1	LNA gain high; PGA gain register set to 11; assumed SNDR > -7dB at sensitivity; interfering signals at front-end input -52dBm, at 5MHz offset and -5MHz offset and modulated as in 3GPP; using UL reference measurement channel (12.2kbps) as specified in C.3.1 3GPP 25.101; production tested by measurement of SNDR at output on CW input signal at -90dBm; SNDR at MAX-PHY filter output established with FFT		-110		dBm
Wb1fd-4a	Sensitivity with Adjacent Channel Interference 3GPP TS25.101 Section 7.5.1 CASE 2	LNA gain medium, PGA gain register set to 6; tested SNDR at output; interfering signals at front-end input -25dBm, at 5MHz offset and -5MHz offset and modulated as in 3GPP; using UL reference measurement channel (12.2kbps) as specified in C.3.1 3GPP 25.101; production tested by measurement of SNDR at output on CW input signal at -69dBm; SNDR at MAX-PHY filter output established with FFT		-94		dBm

MAX2550

Band I, V, and VIII WCDMA Femtocell Transceiver with GSM Monitoring

AC ELECTRICAL CHARACTERISTICS (continued)

(MAX2550 EV kit, $T_A = -40^{\circ}\text{C}$ to $+85^{\circ}\text{C}$, registers set as described in Tables 20–51, $V_{CC_} = 3.0\text{V}$ to 3.6V , $f_{\text{REFIN}} = 19.2\text{MHz}$, all sensitivity levels and blocker levels are antenna referred. Typical values are at $V_{CC_} = 3.3\text{V}$, $T_A = +25^{\circ}\text{C}$ and mid-band, unless otherwise noted. Tx specifications are referred to the input pin of the chip.) (Note 2)

Band I Downlink WCDMA Rx Mode on RXIN5 (Monitor) (continued)

SPEC NO.	PARAMETER	CONDITIONS	MIN	TYP	MAX	UNITS
Wb1fd-8	Sensitivity with Intermodulation Interference 3GPP TS25.101 Section 7.8.1	LNA gain high, PGA gain register set to 11; assumed SNDR > -7dB at sensitivity; interfering signals at front-end input -46dBm, at 10MHz offset (CW) and 20MHz offset (modulated) as in 3GPP; using UL reference measurement channel (12.2kbps) as specified in C.3.1 3GPP 25.101; production tested by measurement of SNDR at output on CW input signal at -90dBm; SNDR at MAX-PHY filter output established with FFT		-110		dBm
Wb1fd-10	Spurious Emissions Out-of-Band 3GPP TS25.101 Section 7.9.1	30MHz to 12750MHz in 100kHz bandwidth (Note 3)		-80	-60	dBm
Wb1fd-11	Spurious Emissions in Receive Bands 3GPP TS25.101 section 7.9.2	Front-end assumed response as above, 1920MHz to 1980MHz and 2110MHz to 2170MHz (Note 3)		-95	-80	dBm
Wb1fd-12	Conversion Gain High LNA Gain	LNA gain high; PGA gain register set to 11; tested on CW input signal at -90dBm; calculated by subtracting the FE input signal in dBm from the ADC output signal in dBFS at digital filter outputs, includes digital gain to the 16-bit output	33	44	49	dB
Wb1fd-13	Conversion Gain Low LNA Gain	LNA gain low; PGA gain register set to 0; tested on CW input signal at -20dBm; calculated by subtracting the FE input signal in dBm from the ADC output signal in dBFS at digital filter outputs, includes digital gain to the 16-bit output	-22	-13	-7.5	dB

MAX2550

Band I, V, and VIII WCDMA Femtocell Transceiver with GSM Monitoring

AC ELECTRICAL CHARACTERISTICS (continued)

(MAX2550 EV kit, $T_A = -40^{\circ}\text{C}$ to $+85^{\circ}\text{C}$, registers set as described in Tables 20–51, $V_{CC_} = 3.0\text{V}$ to 3.6V , $f_{\text{REFIN}} = 19.2\text{MHz}$, all sensitivity levels and blocker levels are antenna referred. Typical values are at $V_{CC_} = 3.3\text{V}$, $T_A = +25^{\circ}\text{C}$ and mid-band, unless otherwise noted. Tx specifications are referred to the input pin of the chip.) (Note 2)

DCS Band Rx Mode on RXIN2

Assumed External Front-End Filtering Characteristics Between Antenna and LNA

BAND (MHz)	In-Band 1805 to 1880	Out of Band (a) 0.1 to 1705	Out of Band (b) 1705 to 1785	Out of Band (c) 1920 to 1980	Out of Band (d) 1980 to 4000
ATTENUATION (dB)	Attenuation	Minimum Attenuation			
	3.5	27.5	15.5	15.5	27.5

DCS Band Rx Mode on RXIN2

SPEC NO.	PARAMETER	CONDITIONS	MIN	TYP	MAX	UNITS
dcs-0	RF Frequency	At pin RXIN2, 200KHz channel raster, lowest to highest channel center frequency	1805.2		1879.8	MHz
dcs-1	Sensitivity 3GPP TS100.910 Section 6.2	LNA gain high, PGA gain register set to 12; assumed SNDR > 7dB at sensitivity; using static E-TCH/F as specified in 3GPP TS 100.910; production tested by measurement of SNDR at output on CW input signal at -102dBm; SNDR at MAX-PHY filter output established with FFT		-108		dBm
dcs-2	Conversion Gain High LNA Gain	LNA gain high, PGA gain register set to 12; production tested on CW input signal at -102dBm; calculated by subtracting the FE input signal in dBm from the output signal in dBFS at digital filter outputs, includes digital gain to the 16-bit output	40	46		dB

EGSM/WCDMA Band Rx Mode on RXIN4

External Front-End Filtering Characteristics EGSM

BAND (MHz)	In-Band 925 to 960	905 to 915	Out of Band (a) 0.1 to 905	Out of Band (b) N/A	Out of Band (c) N/A	Out of Band (d) 980 to 12750
ATTENUATION (dB)	Attenuation	Minimum Attenuation				
	3.5	19.5	24.5	N/A	N/A	24.5

Assumed External Front-End Filtering Characteristics Between Antenna and LNA: (WCDMA on RXIN4)

BAND (MHz)	Downlink 869 to 894	1 to 804	824 to 849	914 to 3000	3000 to 6000	
ATTENUATION (dB)	Attenuation	Minimum Attenuation				
	3	37	51	35	20	

MAX2550

Band I, V, and VIII WCDMA Femtocell Transceiver with GSM Monitoring

AC ELECTRICAL CHARACTERISTICS (continued)

(MAX2550 EV kit, $T_A = -40^{\circ}\text{C}$ to $+85^{\circ}\text{C}$, registers set as described in Tables 20–51, $V_{CC_} = 3.0\text{V}$ to 3.6V , $f_{\text{REFIN}} = 19.2\text{MHz}$, all sensitivity levels and blocker levels are antenna referred. Typical values are at $V_{CC_} = 3.3\text{V}$, $T_A = +25^{\circ}\text{C}$ and mid-band, unless otherwise noted. Tx specifications are referred to the input pin of the chip.) (Note 2)

EGSM/WCDMA Band Rx Mode on RXIN4

SPEC NO.	PARAMETER	CONDITIONS	MIN	TYP	MAX	UNITS
G900 -0	RF Frequency	At pin RXIN4, 200KHz channel raster, EGSM lowest to highest channel center frequency	925.2		959.8	MHz
G900-1	Sensitivity 3GPP TS100.910 Section 6.2	LNA gain high, PGA gain register set to 12; assumed SNDR > 7dB at sensitivity; using static E-TCH/F as specified in 3GPP TS 100.910; production tested by measurement of SNDR at output on CW input signal at -102dBm; SNDR at MAX-PHY filter output established with FFT		-110		dBm
G900-2	Conversion Gain High LNA Gain	LNA gain high, PGA gain register set to 12; production tested on CW input signal at -102dBm; calculated by subtracting the FE input signal in dBm from the output signal in dBFS at digital filter outputs, includes digital gain to the 16-bit output	43	50		dB

Band V Duplexer Specifications

Antenna—Uplink Port (Applies to Uplink WCDMA Rx Mode on RXIN3)

BAND (MHz)	Uplink 824 to 849	1 to 804	869 to 894	894 to 2500	2500 to 3000	3000 to 6000
ATTENUATION (dB)	Attenuation			Minimum Attenuation		
	2	32	43	32	22	15
Rx SAW FILTER RESPONSE						
BAND (MHz)	Out-of-Band					
ATTENUATION (dB)	Required minimum attenuation relative to in-band					
	25					

MAX2550

Band I, V, and VIII WCDMA Femtocell Transceiver with GSM Monitoring

AC ELECTRICAL CHARACTERISTICS (continued)

(MAX2550 EV kit, $T_A = -40^{\circ}\text{C}$ to $+85^{\circ}\text{C}$, registers set as described in Tables 20–51, $V_{CC-} = 3.0\text{V}$ to 3.6V , $f_{\text{REFIN}} = 19.2\text{MHz}$, all sensitivity levels and blocker levels are antenna referred. Typical values are at $V_{CC-} = 3.3\text{V}$, $T_A = +25^{\circ}\text{C}$ and mid-band, unless otherwise noted. Tx specifications are referred to the input pin of the chip.) (Note 2)

Band V Uplink WCDMA Rx Mode on RXIN3 (Full Duplex)

SPEC NO.	PARAMETER	CONDITIONS	MIN	TYP	MAX	UNITS
Wb5fu-0	Frequency Band	WCDMA FDD Band V uplink (lowest to highest channel center frequency)	821.4		846.6	MHz
Wb5fu-1	Sensitivity 3GPP TS25.104 Section 7.2.1	Tx on at -27dBm, LNA gain mid gain, PGA gain register set to 9, assumed SNDR > -17.5dB at sensitivity, using UL reference measurement channel (12.2kbps) as specified in A.2 3GPP 25.104, tested by measurement of SNDR at output on CW input signal at -90dBm, SNDR at MAX-PHY filter output established with FFT, LNA linearity set to high		-116	-107	dBm
Wb5fu-2	Sensitivity with LNA in High-Gain Mode	Tx on at -27dBm, LNA gain high, PGA gain register set to 6, assumed SNDR > -17.5dB at sensitivity, using UL reference measurement channel (12.2kbps) as specified in A.2 3GPP 25.104, tested by measurement of SNDR at output on CW input signal at -90dBm, SNDR at MAX-PHY filter output established with FFT, LNA linearity set to high		-119	-107	dBm
Wb5fu-3	High-Level EVM WCDMA	$P_{\text{IN}} = -20$ dBm, LNA gain low, PGA gain register set to 1		4.0		%
Wb5fu-4	Sensitivity with Adjacent Channel Interference 3GPP TS25.104 Section 7.4.1	Tx on at -27dBm; LNA gain high; PGA gain register set to 3; assumed SNDR > -17.5dB at sensitivity; interfering signals at front-end input -28dBm, at 5MHz offset and -5MHz offset and modulated as in 3GPP; using UL reference measurement channel (12.2kbps) as specified in A.2 3GPP 25.104; tested by measurement of SNDR at output on CW input signal at -90dBm; SNDR at MAX-PHY filter output established with FFT		-108		dBm
Wb5fu-5	Sensitivity with In-Band Blocking Interference 3GPP TS25.104 Section 7.5.1	Tx on at -27dBm; LNA gain high; PGA gain register set to 6; assumed SNDR > -17.5dB at sensitivity; interfering signal at front-end input -30dBm at min, 10MHz offset modulated as in 3GPP; using UL reference measurement channel (12.2kbps) as specified in A.2 3GPP 25.104; tested by measurement of SNDR at output on CW input signal at -90dBm; (test only worst case in production); SNDR at MAX-PHY filter output established with FFT (Note 3)		-117	-101	dBm

MAX2550

Band I, V, and VIII WCDMA Femtocell Transceiver with GSM Monitoring

AC ELECTRICAL CHARACTERISTICS (continued)

(MAX2550 EV kit, $T_A = -40^{\circ}\text{C}$ to $+85^{\circ}\text{C}$, registers set as described in Tables 20–51, $V_{CC_} = 3.0\text{V}$ to 3.6V , $f_{\text{REFIN}} = 19.2\text{MHz}$, all sensitivity levels and blocker levels are antenna referred. Typical values are at $V_{CC_} = 3.3\text{V}$, $T_A = +25^{\circ}\text{C}$ and mid-band, unless otherwise noted. Tx specifications are referred to the input pin of the chip.) (Note 2)

Band V Uplink WCDMA Rx Mode on RXIN3 (Full Duplex) (continued)

SPEC NO.	PARAMETER	CONDITIONS	MIN	TYP	MAX	UNITS
Wb5fu-6	Sensitivity with Out-of-Band Blocking Interference 3GPP TS25.104 Section 7.5.1	Front-end assumed response as above; Tx on at -27dBm; LNA gain high; PGA gain register set to 6; assumed SNDR > -17.5dB at sensitivity; interfering signal at Front-end input -15dBm CW; 1MHz to 804MHz and 869MHz to 12750MHz with 1 MHz steps; no exceptions allowed; (test only worst case in production); using UL reference measurement channel (12.2kbps) as specified in A.2 3GPP 25.104; tested by measurement of SNDR at output on CW input signal at -90dBm; SNDR at MAX-PHY filter output established with FFT		-111		dBm
Wb5fu-7	Sensitivity with Intermodulation Interference 3GPP TS25.104 Section 7.6.1	Tx on at -27dBm; LNA gain high; PGA gain register set to 6; assumed SNDR > -17.5dB at sensitivity; interfering signals at front-end input -38dBm, at 10MHz offset (CW) and 20MHz offset (modulated) as in 3GPP; using UL reference measurement channel (12.2kbps) as specified in A.2 3GPP 25.104; tested by measurement of SNDR at output on CW input signal at -90dBm; SNDR at MAX-PHY filter output established with FFT (Note 3)		-117	-101	dBm
Wb5fu-8	Spurious Emissions Out-of-Band 3GPP TS25.104 Section 7.7.1	30MHz to 1GHz, measured in 100kHz BW		-100	-60	dBm
		1GHz to 12.75GHz, measured in 1MHz BW, with the exception of frequencies between 12.5MHz below the first carrier frequency and 12.5MHz above the last carrier frequency used by the BS (Note 3)		-86	-50	
Wb5fu-10	Conversion Gain High LNA Gain	LNA high gain; PGA gain register set to 6; tested on CW input signal at -90dBm; calculated by subtracting the FE input signal in dBm from the ADC output signal in dBFS at digital filter outputs, includes digital gain to the 16-bit output	22	29.5	35	dB
Wb5fu-11	Conversion Gain Mid LNA Gain	LNA mid gain; PGA gain register set to 9; tested on CW input signal at -90dBm; calculated by subtracting the FE input signal in dBm from the ADC output signal in dBFS at digital filter outputs, includes digital gain to the 16-bit output	22	29	35	dB

MAX2550

Band I, V, and VIII WCDMA Femtocell Transceiver with GSM Monitoring

AC ELECTRICAL CHARACTERISTICS (continued)

(MAX2550 EV kit, $T_A = -40^{\circ}\text{C}$ to $+85^{\circ}\text{C}$, registers set as described in Tables 20–51, $V_{CC_} = 3.0\text{V}$ to 3.6V , $f_{\text{REFIN}} = 19.2\text{MHz}$, all sensitivity levels and blocker levels are antenna referred. Typical values are at $V_{CC_} = 3.3\text{V}$, $T_A = +25^{\circ}\text{C}$ and mid-band, unless otherwise noted. Tx specifications are referred to the input pin of the chip.) (Note 2)

Band V Uplink WCDMA Rx Mode on RXIN3 (Full Duplex) (continued)

SPEC NO.	PARAMETER	CONDITIONS	MIN	TYP	MAX	UNITS
Wb5fu-12	Conversion Gain Low LNA Gain	LNA gain low; PGA gain register set to 1; tested on CW input signal at -20dBm; calculated by subtracting the FE input signal in dBm from the ADC output signal in dBFS at digital filter outputs, includes digital gain to the 16-bit output	-17.5	-10.5	-6	dB

Antenna—Downlink Port (Applies to Downlink WCDMA Rx Mode on RXIN4)

BAND (MHz)	Downlink 869 to 894	1 to 804	824 to 849	914 to 3000	3000 to 6000
ATTENUATION (dB)	Attenuation	Minimum Attenuation			
	3	37	51	35	20

Band V Downlink WCDMA Rx Mode on RXIN4 (Monitor)

SPEC NO.	PARAMETER	CONDITIONS	MIN	TYP	MAX	UNITS
Wb5fd-0	Frequency Band		867.4		891.6	MHz
Wb5fd-1	Sensitivity 3GPP TS25.101 Section 7.3.1	LNA gain high, PGA gain register set to 11, assumed SNDR > -7dB at sensitivity, using UL reference measurement channel (12.2kbps) as specified in C.3.1 3GPP 25.101, tested by measurement of SNDR at output on CW input signal at -90dBm, SNDR at MAX-PHY filter output established with FFT, LNA linearity set to high		-111.5	-104.7	dBm
Wb5fd-4	Sensitivity with Adjacent Channel Interference 3GPP TS25.101 Section 7.5.1	LNA gain high; PGA gain register set to 11; assumed SNDR > -7dB at sensitivity; interfering signals at front-end input -52dBm, at 5MHz offset and -5MHz offset and modulated as in 3GPP; using UL reference measurement channel (12.2kbps) as specified in C.3.1 3GPP 25.101; tested by measurement of SNDR at output on CW input signal at -90dBm; SNDR at MAX-PHY filter output established with FFT		-111	-101	dBm
Wb5fd-9	Spurious Emissions Out-of-Band 3GPP TS25.101 Section 7.9.1 (Note 3)	30MHz to 1000MHz, 100kHz bandwidth		-100	-60	dBm
		1000MHz to 12750MHz, 1MHz bandwidth		-98	-50	

MAX2550

Band I, V, and VIII WCDMA Femtocell Transceiver with GSM Monitoring

AC ELECTRICAL CHARACTERISTICS (continued)

(MAX2550 EV kit, $T_A = -40^{\circ}\text{C}$ to $+85^{\circ}\text{C}$, registers set as described in Tables 20–51, $V_{CC-} = 3.0\text{V}$ to 3.6V , $f_{\text{REFIN}} = 19.2\text{MHz}$, all sensitivity levels and blocker levels are antenna referred. Typical values are at $V_{CC-} = 3.3\text{V}$, $T_A = +25^{\circ}\text{C}$ and mid-band, unless otherwise noted. Tx specifications are referred to the input pin of the chip.) (Note 2)

Band V Downlink WCDMA Rx Mode on RXIN4 (Monitor) (continued)

SPEC NO.	PARAMETER	CONDITIONS	MIN	TYP	MAX	UNITS
Wb5fd-10	Spurious Emissions in Receive Bands 3GPP TS25.101 Section 7.9.2	Front-end assumed response as above, 824MHz to 849MHz and 869MHz to 894MHz (Note 3)		-95	-80	dBm
Wb5fd-11	Conversion Gain High LNA Gain	LNA gain high; PGA gain register set to 11; tested on CW input signal at -90dBm; calculated by subtracting the FE input signal in dBm from the ADC output signal in dBFS at digital filter outputs, includes digital gain to the 16-bit output	40	45	48.5	dB
Wb5fd-12	Conversion Gain Low LNA Gain	LNA gain low; PGA gain register set to 0; tested on CW input signal at -20dBm; calculated by subtracting the FE input signal in dBm from the ADC output signal in dBFS at digital filter outputs, includes digital gain to the 16-bit output	-18	-14	-10	dB

Band VIII Duplexer Specifications

Antenna—Uplink Port (Applies to Uplink WCDMA Rx Mode on RXIN3)

BAND (MHz)	Uplink 880 to 915	1 to 870	925 to 960	960 to 2500	2500 to 3000	3000 to 6000
ATTENUATION (dB)	Attenuation			Minimum Attenuation		
	2	32	43	32	22	15
Rx SAW FILTER RESPONSE						
BAND (MHz)	Out-of-band					
ATTENUATION (dB)	Required minimum attenuation relative to in-band					
	25					

MAX2550

Band I, V, and VIII WCDMA Femtocell Transceiver with GSM Monitoring

AC ELECTRICAL CHARACTERISTICS (continued)

(MAX2550 EV kit, $T_A = -40^{\circ}\text{C}$ to $+85^{\circ}\text{C}$, registers set as described in Tables 20–51, $V_{CC-} = 3.0\text{V}$ to 3.6V , $f_{\text{REFIN}} = 19.2\text{MHz}$, all sensitivity levels and blocker levels are antenna referred. Typical values are at $V_{CC-} = 3.3\text{V}$, $T_A = +25^{\circ}\text{C}$ and mid-band, unless otherwise noted. Tx specifications are referred to the input pin of the chip.) (Note 2)

Band VIII Uplink WCDMA Rx Mode on RXIN3 (Full Duplex)

SPEC NO.	PARAMETER	CONDITIONS	MIN	TYP	MAX	UNITS
Wb8fu-0	Frequency Band	WCDMA FDD Band V uplink (lowest to highest channel center frequency)	882.4		912.6	MHz
Wb8fu-1	Sensitivity 3GPP TS25.104 Section 7.2.1	Tx on at -27dBm, LNA gain mid gain, PGA gain register set to 9, assumed SNDR > -17.5dB at sensitivity, using UL reference measurement channel (12.2kbps) as specified in A.2 3GPP 25.104, tested by measurement of SNDR at output on CW input signal at -90dBm, SNDR at MAX-PHY filter output established with FFT, LNA linearity set to high (Note 3)		-116	-107	dBm
Wb8fu-2	Sensitivity with LNA in High-Gain Mode	Tx on at -27dBm, LNA gain high, PGA gain register set to 6, assumed SNDR > -17.5dB at sensitivity, using UL reference measurement channel (12.2kbps) as specified in A.2 3GPP 25.104, tested by measurement of SNDR at output on CW input signal at -90dBm, SNDR at MAX-PHY filter output established with FFT, LNA linearity set to high		-120	-107	dBm
Wb8fu-3	High-Level EVM WCDMA	$P_{\text{IN}} = -20\text{dBm}$, LNA gain low, PGA gain register set to 1		4.0		%
Wb8fu-4	Sensitivity with Adjacent Channel Interference 3GPP TS25.104 Section 7.4.1	Tx on at -27dBm; LNA gain high; PGA gain register set to 3; assumed SNDR > -17.5dB at sensitivity; interfering signals at front-end input -28dBm, at 5MHz offset and -5MHz offset and modulated as in 3GPP; using UL reference measurement channel (12.2kbps) as specified in A.2 3GPP 25.104; tested by measurement of SNDR at output on CW input signal at -90dBm; SNDR at MAX-PHY filter output established with FFT (Note 3)		-107	-101	dBm
Wb8fu-5	Sensitivity with In-Band Blocking Interference 3GPP TS25.104 Section 7.5.1	Tx on at -27dBm; LNA gain high; PGA gain register set to 6; assumed SNDR > -17.5dB at sensitivity; interfering signal at front-end input -30dBm at min, 10MHz offset modulated as in 3GPP; using UL reference measurement channel (12.2kbps) as specified in A.2 3GPP 25.104; tested by measurement of SNDR at output on CW input signal at -90dBm; (test only worst case in production); SNDR at MAX-PHY filter output established with FFT (Note 3)		-118	-101	dBm

MAX2550

Band I, V, and VIII WCDMA Femtocell Transceiver with GSM Monitoring

AC ELECTRICAL CHARACTERISTICS (continued)

(MAX2550 EV kit, $T_A = -40^{\circ}\text{C}$ to $+85^{\circ}\text{C}$, registers set as described in Tables 20–51, $V_{CC_} = 3.0\text{V}$ to 3.6V , $f_{\text{REFIN}} = 19.2\text{MHz}$, all sensitivity levels and blocker levels are antenna referred. Typical values are at $V_{CC_} = 3.3\text{V}$, $T_A = +25^{\circ}\text{C}$ and mid-band, unless otherwise noted. Tx specifications are referred to the input pin of the chip.) (Note 2)

Band VIII Uplink WCDMA Rx Mode on RXIN3 (Full Duplex) (continued)

SPEC NO.	PARAMETER	CONDITIONS	MIN	TYP	MAX	UNITS
Wb8fu-6	Sensitivity with Out-of-Band Blocking Interference 3GPP TS25.104 Section 7.5.1	Front-end assumed response as above; Tx on at -27dBm; LNA gain high; PGA gain register set to 6; assumed SNDR > -17.5dB at sensitivity; interfering signal at front-end input -15dBm CW; 1MHz to 804MHz and 869MHz to 12750MHz with 1 MHz steps; no exceptions allowed; (test only worst case in production); using UL reference measurement channel (12.2kbps) as specified in A.2 3GPP 25.104; tested by measurement of SNDR at output on CW input signal at -90dBm; SNDR at MAX-PHY filter output established with FFT (Note 3)		-113	-101	dBm
Wb8fu-7	Sensitivity with Intermodulation Interference 3GPP TS25.104 Section 7.6.1	Tx on at -27dBm; LNA gain high; PGA gain register set to 6; assumed SNDR > -17.5dB at sensitivity; interfering signals at front-end input -38dBm, at 10MHz offset (CW) and 20MHz offset (modulated) as in 3GPP; using UL reference measurement channel (12.2kbps) as specified in A.2 3GPP 25.104; tested by measurement of SNDR at output on CW input signal at -90dBm; SNDR at MAX-PHY filter output established with FFT (Note 3)		-118	-101	dBm
Wb8fu-8	Spurious Emissions Out-of-Band 3GPP TS25.104 Section 7.7.1	30MHz to 1GHz, measured in 100kHz BW		-100	-60	dBm
		1GHz to 12.75GHz, measured in 1MHz BW, with the exception of frequencies between 12.5MHz below the first carrier frequency and 12.5MHz above the last carrier frequency used by the BS (Note 3)		-78	-50	
Wb8fu-10	Conversion Gain High LNA Gain	LNA high gain; PGA gain register set to 6; tested on CW input signal at -90dBm; calculated by subtracting the FE input signal in dBm from the ADC output signal in dBFS at digital filter outputs, includes digital gain to the 16-bit output	23	30	35	dB
Wb8fu-11	Conversion Gain Mid LNA Gain	LNA mid gain; PGA gain register set to 9; tested on CW input signal at -90dBm; calculated by subtracting the FE input signal in dBm from the ADC output signal in dBFS at digital filter outputs, includes digital gain to the 16-bit output	22	29.5	35	dB

MAX2550

Band I, V, and VIII WCDMA Femtocell Transceiver with GSM Monitoring

AC ELECTRICAL CHARACTERISTICS (continued)

(MAX2550 EV kit, $T_A = -40^{\circ}\text{C}$ to $+85^{\circ}\text{C}$, registers set as described in Tables 20–51, $V_{CC-} = 3.0\text{V}$ to 3.6V , $f_{\text{REFIN}} = 19.2\text{MHz}$, all sensitivity levels and blocker levels are antenna referred. Typical values are at $V_{CC-} = 3.3\text{V}$, $T_A = +25^{\circ}\text{C}$ and mid-band, unless otherwise noted. Tx specifications are referred to the input pin of the chip.) (Note 2)

Band VIII Uplink WCDMA Rx Mode on RXIN3 (Full Duplex) (continued)

SPEC NO.	PARAMETER	CONDITIONS	MIN	TYP	MAX	UNITS
Wb8fu-12	Conversion Gain Low LNA Gain	LNA gain low; PGA gain register set to 1; tested on CW input signal at -20dBm; calculated by subtracting the FE input signal in dBm from the ADC output signal in dBFS at digital filter outputs, includes digital gain to the 16-bit output	-16	-9	-5	dB

Antenna—Downlink Port (Applies to Downlink WCDMA Rx Mode on RXIN4)

BAND (MHz)	Downlink 925 to 960	1 to 804	880 to 915	914 to 3000	3000 to 6000
ATTENUATION (dB)	Attenuation	Minimum Attenuation			
	3	37	51	35	20

Band VIII Downlink WCDMA Rx Mode on RXIN4 (Monitor)

SPEC NO.	PARAMETER	CONDITIONS	MIN	TYP	MAX	UNITS
Wb8fd-0	Frequency Band		927.4		957.6	MHz
Wb8fd-1	Sensitivity 3GPP TS25.101 Section 7.3.1	LNA gain high, PGA gain register set to 11, assumed SNDR > -7dB at sensitivity, using UL reference measurement channel (12.2kbps) as specified in C.3.1 3GPP 25.101, tested by measurement of SNDR at output on CW input signal at -90dBm, SNDR at MAX-PHY filter output established with FFT, LNA linearity set to high, specified data is for a manual built fCLGA using 2.7pF filter caps		-111.5	-104.7	dBm
Wb8fd-4	Sensitivity with Adjacent Channel Interference 3GPP TS25.101 Section 7.5.1	LNA gain high; PGA gain register set to 11; assumed SNDR > -7dB at sensitivity; interfering signals at front-end input -52dBm, at 5MHz offset and -5MHz offset and modulated as in 3GPP; using UL reference measurement channel (12.2kbps) as specified in C.3.1 3GPP 25.101; tested by measurement of SNDR at output on CW input signal at -90dBm; SNDR at MAX-PHY filter output established with FFT		-111	-101	dBm

MAX2550

Band I, V, and VIII WCDMA Femtocell Transceiver with GSM Monitoring

AC ELECTRICAL CHARACTERISTICS (continued)

(MAX2550 EV kit, $T_A = -40^{\circ}\text{C}$ to $+85^{\circ}\text{C}$, registers set as described in Tables 20–51, $V_{CC-} = 3.0\text{V}$ to 3.6V , $f_{\text{REFIN}} = 19.2\text{MHz}$, all sensitivity levels and blocker levels are antenna referred. Typical values are at $V_{CC-} = 3.3\text{V}$, $T_A = +25^{\circ}\text{C}$ and mid-band, unless otherwise noted. Tx specifications are referred to the input pin of the chip.) (Note 2)

Band VIII Downlink WCDMA Rx Mode on RXIN4 (Monitor) (continued)

SPEC NO.	PARAMETER	CONDITIONS	MIN	TYP	MAX	UNITS
Wb8fd-9	Spurious Emissions Out-of-Band 3GPP TS25.101 Section 7.9.1 (Note 3)	30MHz to 1000MHz, 100kHz bandwidth		-100	-60	dBm
		1000MHz to 12750MHz, 1MHz bandwidth		-90	-50	
Wb8fd-10	Spurious Emissions in Receive Bands 3GPP TS25.101 Section 7.9.2	Front-end assumed response as above, 925MHz to 960MHz and 880MHz to 915MHz (Note 3)		-100	-80	dBm
Wb8fd-11	Conversion Gain High LNA Gain	LNA gain high; PGA gain register set to 11; tested on CW input signal at -90dBm; calculated by subtracting the FE input signal in dBm from the ADC output signal in dBFS at digital filter outputs, includes digital gain to the 16-bit output	40	44.5	49	dB
Wb8fd-12	Conversion Gain Low LNA Gain	LNA gain low; PGA gain register set to 0; tested on CW input signal at -20dBm; calculated by subtracting the FE input signal in dBm from the ADC output signal in dBFS at digital filter outputs, includes digital gain to the 16-bit output	-17.5	-12	-8.5	dB

MAX2550

Band I, V, and VIII WCDMA Femtocell Transceiver with GSM Monitoring

Tx MODE AC ELECTRICAL CHARACTERISTICS

(MAX2550 EV kit, $T_A = -40^{\circ}\text{C}$ to $+85^{\circ}\text{C}$, WCDMA downlink TM1 16 channels with -14dBfs peak level into sigma-delta modulator inside baseband chip (see the *Baseband Input Level* section), registers set as described in Tables 20–51, $V_{CC_} = 3.0\text{V}$ to 3.6V , $f_{\text{REFIN}} = 19.2\text{MHz}$, typical values are at $T_A = +25^{\circ}\text{C}$, $V_{CC_} = 3.3\text{V}$, and mid-band, unless otherwise noted. Tx specifications are referred to the input pin of the chip.) (Note 2)

SPEC NO.	PARAMETER	CONDITIONS	MIN	TYP	MAX	UNITS
W1	RF Frequency Range	Center of the WCDMA signal, Band I output (TXOUTH)	2112.4		2167.6	MHz
W1a		Band V and VIII output (TXOUTL)	Band V	867.4	891.6	MHz
W1b			Band VIII	927.4	957.6	
W2	Linear Output Power	TX_GAIN = 1023	0			dBm
W3	Adjacent Channel Power Ratio	Offset frequency = $\pm 5\text{MHz}$ in 3.84MHz BW, $P_{\text{OUT}} = 0\text{dBm}$		-55		dBc
W4	Alternate Channel Power Ratio	Offset frequency = $\pm 10\text{MHz}$ in 3.84MHz BW, $P_{\text{OUT}} = 0\text{dBm}$		-70		dBc
W5	Rx Band Noise Power, $P_{\text{OUT}} \leq 0\text{dBm}$ (Note 3)	Noise measured at -80MHz offset in 3.84MHz BW, then convert to per Hz, Band I output		-149	-142	dBm/Hz
W5a		Noise measured at -45MHz offset in 3.84MHz BW, then convert to per Hz, Band V and VIII output		-145	-140	dBm/Hz
W6	EVM	$P_{\text{OUT}} = 0\text{dBm}$		4		%
W6a	RCDE	TM6, 8 channels at 0dBm		-28		dB
W7	Minimum Output Power	TX_GAIN = 0		-61	-45	dBm
W8	Output Power Deviation from $T_A = +25^{\circ}\text{C}$ to -40°C (Note 3)	TX_GAIN = 1023, high band	-1.5	+0.4	+2	dB
		Low band	-0.5	+1.5	+3.5	
W9	Output Power Deviation from $T_A = +25^{\circ}\text{C}$ to $+85^{\circ}\text{C}$ (Note 3)	TX_GAIN = 1023, high band	-3	-0.8	0	dB
		Low band	-3.5	-1.6	0	
W10	Power Control Step Size Accuracy	Five calibration points over the power control range to create four linear regions, any linearly interpolated 1dB TX_GAIN step over the specified power range (W2 and W7) produces 1dB output power step within this error range.		± 0.25		dB
W11	Power Control Step Size Accuracy	Five calibration points over the power control range to create four linear regions, any linearly interpolated 10dB TX_GAIN step over the specified power range (W2 and W7) produces 10dB output power step within this error range.		± 0.75		dB

MAX2550

Band I, V, and VIII WCDMA Femtocell Transceiver with GSM Monitoring

AC ELECTRICAL CHARACTERISTICS: General

(MAX2550 EV kit, $T_A = -40^{\circ}\text{C}$ to $+85^{\circ}\text{C}$, registers set as described in Tables 20–51, $V_{CC_} = 3.0\text{V}$ to 3.6V , $f_{\text{REFIN}} = 19.2\text{MHz}$, all sensitivity levels and blocker levels are antenna referred, typical values are at $T_A = +25^{\circ}\text{C}$, $V_{CC_} = 3.3\text{V}$, unless otherwise noted.) (Note 2)

SPEC NO.	PARAMETER	CONDITIONS	MIN	TYP	MAX	UNITS
REFERENCE FREQUENCY INPUT						
R1	Input Level	Test condition	125		600	mV _{P-P}
R2	Input Frequency	Reference divider set to divide-by-2 for frequencies higher than 26MHz	13	19.2	40	MHz
REFERENCE FREQUENCY OUTPUT						
RO1a	REFOUT Output Level, AC	500 Ω 22pF load, REFOUT_LV_CMOS_SEL = 1	110	320	500	mV _{P-P}
RO1b	REFOUT Output Level, DC			0.8		V
RO2	REFOUT Output Amplitude	500 Ω 22pF load, REFOUT_LV_CMOS_SEL = 0	2.25	2.7		V _{P-P}
RO4	REFOUT Output Frequency	Matches REFIN frequency (FREF)	13	19.2	40	MHz
Rx DIGITAL LOW-VOLTAGE DIFFERENTIAL SIGNALING OUTPUT INTERFACE						
LV0	Output Bit Rate on Each I and Q	Test condition		153.6		Mbps
LV1	Output Common Mode			1.2		V
LV3	Output Differential Swing on Load (Note 3)	120 Ω differential output load (Note 3)	100	140	220	mV _{PEAK}
LV4	Differential Output Resistance			670		Ω
Tx BASEBAND INTERFACE						
Bb1	Input Bit Rate, on Each I and Q	Test condition		153.6		Mbps
Bb8	Common Mode Input Voltage			1.25		V
Bb9	Differential Input Swing		112	140	500	mV _{P-P}
Bb10	Differential Input	Bit TXINDACZI = 1	55	100	140	Ω
Bb11	Resistance (Note 3)	Bit TXINDACZI = 0	140	220	340	
Rx RF PLL						
RS1	Valid RF Main Division Ratio Range		62		147	
RS3	Valid Main Fractional Divider Programming Value	20-bit resolution	00000		FFFFF	hex
RS5	Charge-Pump Current Gain	Using 800 μA setting	0.5	0.82	1.0	mA
RS6a	VCO Tuning Gain	RXVCO, high band	38	127	216	MHz/V
RS6b		RXVCO, low band	21	65	111	
RS9	PLL Settling Time	50kHz loop bandwidth		200		μs

MAX2550

Band I, V, and VIII WCDMA Femtocell Transceiver with GSM Monitoring

AC ELECTRICAL CHARACTERISTICS: General (continued)

(MAX2550 EV kit, $T_A = -40^{\circ}\text{C}$ to $+85^{\circ}\text{C}$, registers set as described in Tables 20–51, $V_{CC_} = 3.0\text{V}$ to 3.6V , $f_{\text{REFIN}} = 19.2\text{MHz}$, all sensitivity levels and blocker levels are antenna referred, typical values are at $T_A = +25^{\circ}\text{C}$, $V_{CC_} = 3.3\text{V}$, unless otherwise noted.) (Note 2)

SPEC NO.	PARAMETER	CONDITIONS	MIN	TYP	MAX	UNITS
Tx RF PLL						
TS2	Valid RF Main Division Ratio Range		66		153	
TS3	Valid Reference Division Ratios	Division ratios are 1 or 2	1		2	
TS4	Valid Main Fractional Divider Programming Value	20-bit resolution	00000		FFFFF	hex
TS5	Charge-Pump Current CP	800 μA	0.5	0.82	1.0	mA
TS9	PLL Settling Time	50kHz loop bandwidth		200		μs
DAC1	Resolution	Monotonicity is production tested		12		Bits
AFC DAC						
DAC3	Output-Voltage High	Load > 200k Ω to GND, AFCDAC = all 1	2.55	2.68		V
DAC4	Output-Voltage Low	Load > 200k Ω to $V_{CC_}$, AFCDAC = all 0		0.37	0.45	V
DAC5	Output Noise	Any code within 0.5V to 2.5V output level, 100Hz to 20kHz		6		$\mu\text{V}/\text{rtHz}$
DAC6	Settling Time	Step from 0.6V to 2V, settling to $\pm 10\text{mV}$				μs
DIGITAL TEMPERATURE SENSOR						
T1	Output Code vs. Temperature	$T_A = -40^{\circ}\text{C}$		5		%code
T2		$T_A = +25^{\circ}\text{C}$		17		
T3		$T_A = +85^{\circ}\text{C}$		27		
T5	Code Slope	$T_A = -20^{\circ}\text{C}$ to $+70^{\circ}\text{C}$		5		
ISOLATION						
M1	RXIN_ Pin-to-Pin Isolation	Between any RXIN_ pins, with one of the two ports disabled		30		dB
M2	TXOUT_ to RXIN_ Isolation	Between any TXOUT and RXIN_, with both ports on		60		dB

Note 2: Production tested at $T_A = +25^{\circ}\text{C}$. Cold and hot are guaranteed by design and characterization.

Note 3: Guaranteed by design and characterization.

MAX2550

Band I, V, and VIII WCDMA Femtocell Transceiver with GSM Monitoring

General Comments

MAX-PHY

MAX-PHY is Maxim's solution for the digital interface system between the radio IC and the baseband/DSP. It is a multimode, software programmable, digital signal post-processing engine that processes the data out of the radio IC and produces the digital filtered outputs for use in the DSP. It enables multimode operation of the radio through software control. Maxim offers an evaluation kit for the MAX2550 along with an FPGA-based MAX-PHY evaluation platform. The FPGA includes the recommended digital channel-selection filters. The Verilog code for these filters is also available for integration into the DSP. Contact Maxim for further information.

Additional Information

The specifications in the following pages calculate sensitivity with a specified front-end loss from a measured signal-to-noise and distortion ratio (SNDR) and an assumed minimum output SNDR_{SENS} needed for demodulation at sensitivity. The sensitivity values can be related to noise figure by the formula:

$$\text{Noise Figure of MAX2550 (dB)} = \text{Sensitivity (dBm)} - \text{Front-End Loss (dB)} - \text{SNDR}_{\text{SENS}} \text{ (dB)} + 174 \text{ dBm/Hz} - 10 \times \text{LOG}(\text{bandwidth in Hz})$$

Low-noise amplifier (LNA) and programmable-gain amplifier (PGA) gain are set according to the Conditions column in the *Electrical Characteristics* table. The output SNDR is measured using MAX-PHY and the bandwidth of the measurement is defined by the digital filters in MAX-PHY. DC at the output is excluded from the SNDR measurement. SNDR is calculated using an FFT of the output bytes with a typical FFT length of 2¹⁴ output samples.

Typical Operating Characteristics

(MAX2550 EV kit and MAX-PHY FPGA evaluation platform, T_A = +25°C, unless otherwise noted. Registers set as described in Tables 20 and 21, V_{CC_} = 3.3V, f_{REFIN} = 19.2MHz, all sensitivity levels and blocker levels are antenna referred.)

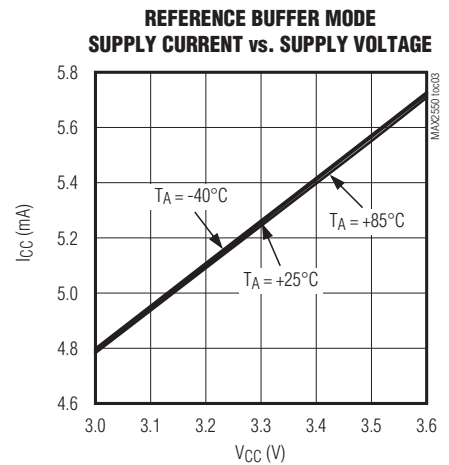
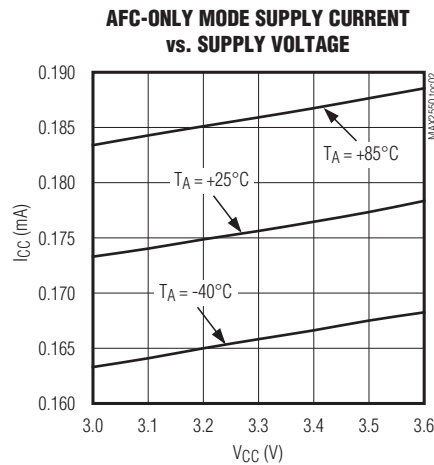
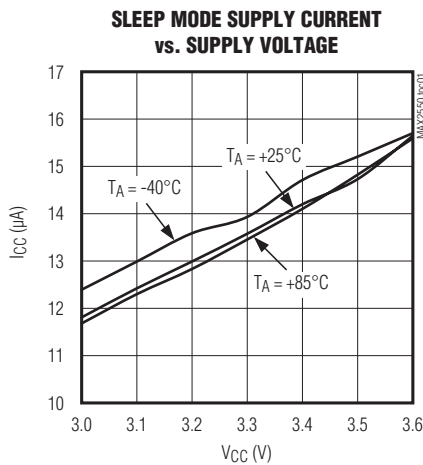

MAX2550

Band I, V, and VIII WCDMA Femtocell Transceiver with GSM Monitoring

Typical Operating Characteristics (continued)

(MAX2550 EV kit and MAX-PHY FPGA evaluation platform, $T_A = +25^\circ\text{C}$, unless otherwise noted. Registers set as described in Tables 20 and 21, $V_{CC_} = 3.3\text{V}$, $f_{\text{REFIN}} = 19.2\text{MHz}$, all sensitivity levels and blocker levels are antenna referred.)

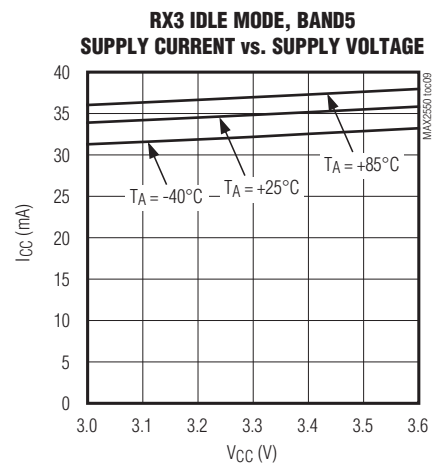
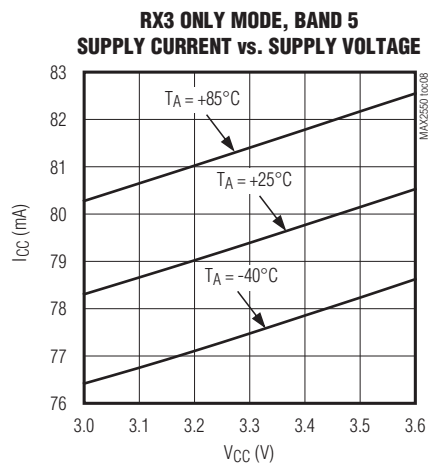
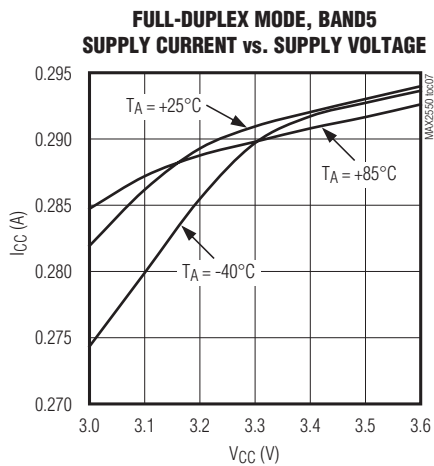
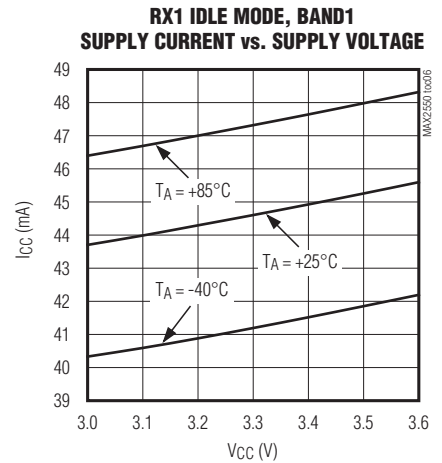
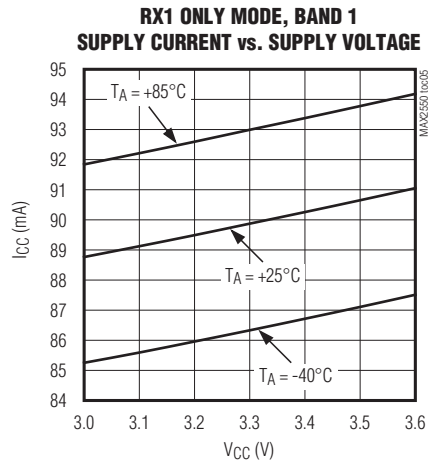
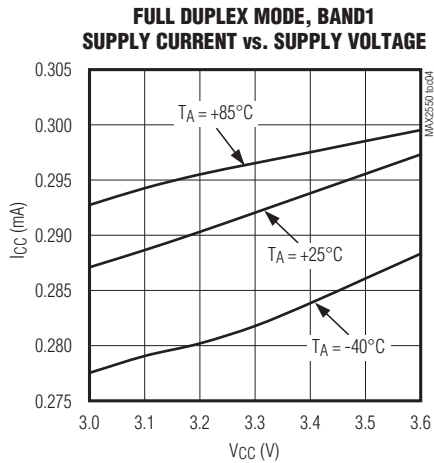

MAX2550

Band I, V, and VIII WCDMA Femtocell Transceiver with GSM Monitoring

Typical Operating Characteristics (continued)

(MAX2550 EV kit and MAX-PHY FPGA evaluation platform, $T_A = +25^\circ\text{C}$, unless otherwise noted. Registers set as described in Tables 20 and 21, $V_{CC_} = 3.3\text{V}$, $f_{\text{REFIN}} = 19.2\text{MHz}$, all sensitivity levels and blocker levels are antenna referred.)

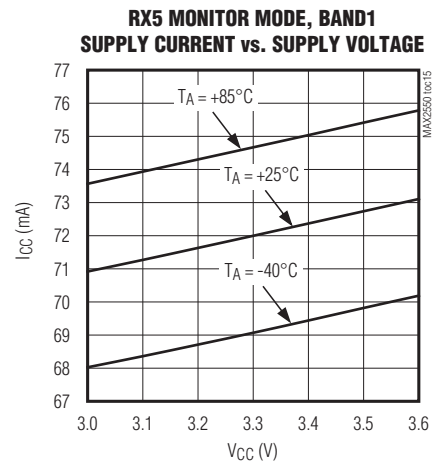
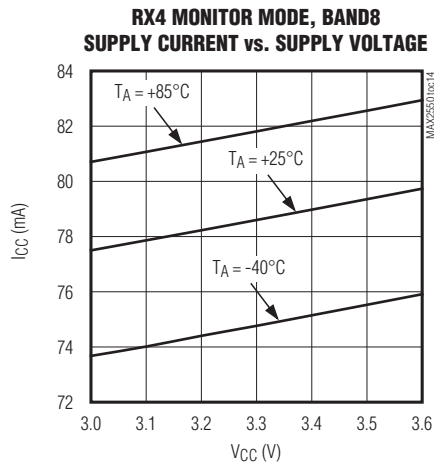
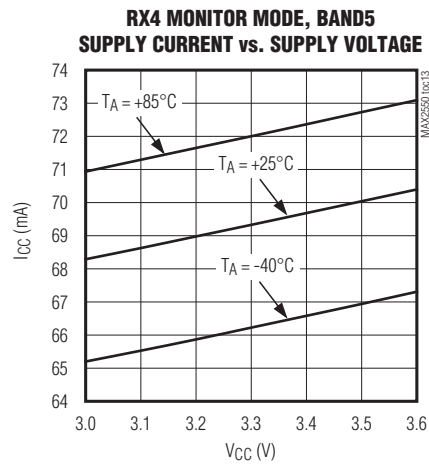
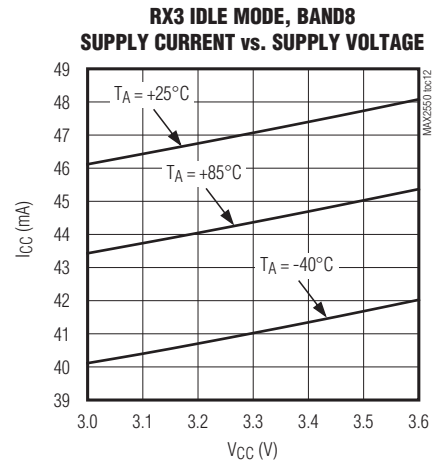
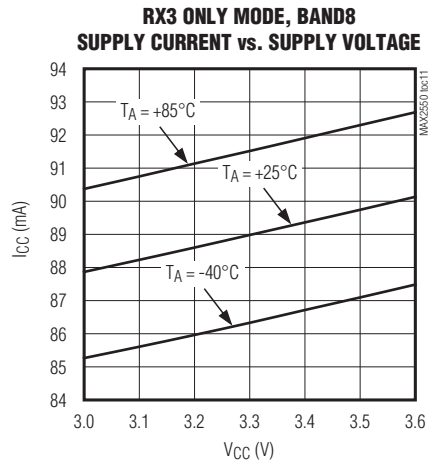
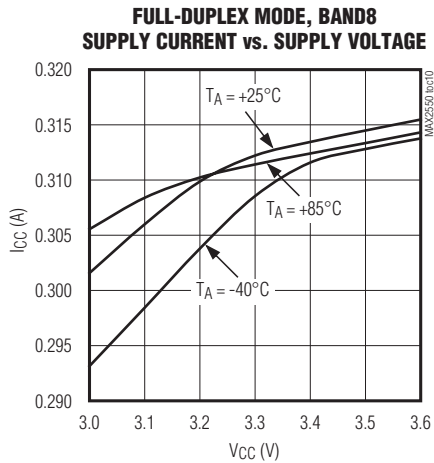

MAX2550

Band I, V, and VIII WCDMA Femtocell Transceiver with GSM Monitoring

Typical Operating Characteristics (continued)

(MAX2550 EV kit and MAX-PHY FPGA evaluation platform, $T_A = +25^\circ\text{C}$, unless otherwise noted. Registers set as described in Tables 20 and 21, $V_{CC_} = 3.3\text{V}$, $f_{\text{REFIN}} = 19.2\text{MHz}$, all sensitivity levels and blocker levels are antenna referred.)

**RX2 MONITOR MODE, DCS
SUPPLY CURRENT vs. SUPPLY VOLTAGE**

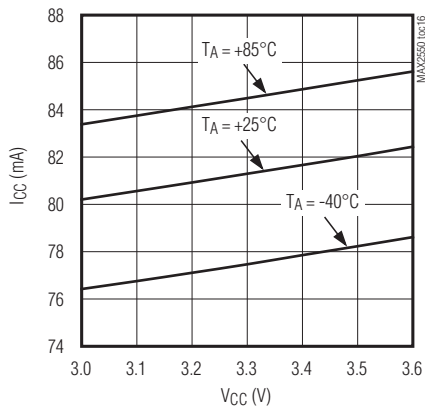

**RX4 MONITOR MODE, GSM
SUPPLY CURRENT vs. SUPPLY VOLTAGE**

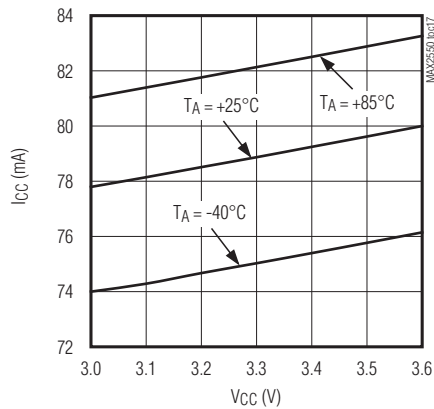

**BAND1 UPLINK Rx
SENSITIVITY vs. FREQUENCY**

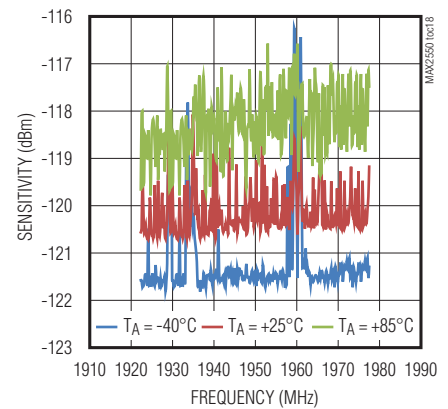

**BAND5 UPLINK Rx
SENSITIVITY vs. FREQUENCY**

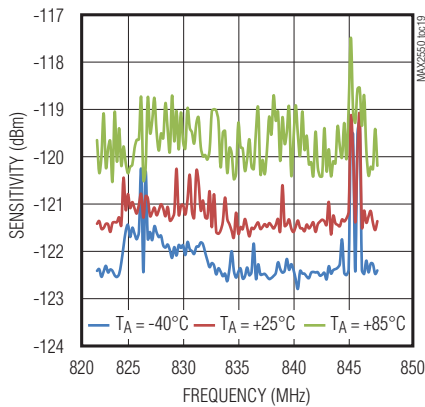

**BAND8 UPLINK Rx
SENSITIVITY vs. FREQUENCY**

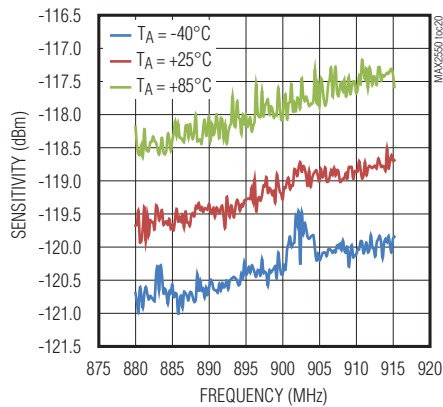

**BAND5 DOWNLINK Rx
SENSITIVITY vs. FREQUENCY**

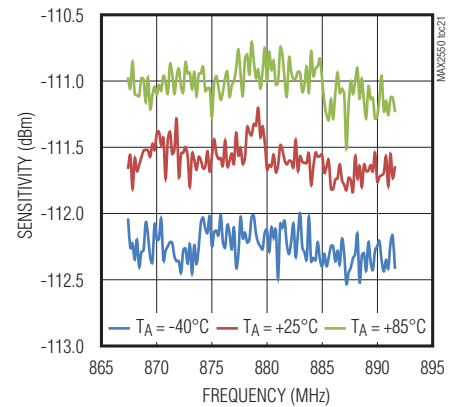

MAX2550

Band I, V, and VIII WCDMA Femtocell Transceiver with GSM Monitoring

Typical Operating Characteristics (continued)

(MAX2550 EV kit and MAX-PHY FPGA evaluation platform, $T_A = +25^\circ\text{C}$, unless otherwise noted. Registers set as described in Tables 20 and 21, $V_{CC_} = 3.3\text{V}$, $f_{\text{REFIN}} = 19.2\text{MHz}$, all sensitivity levels and blocker levels are antenna referred.)

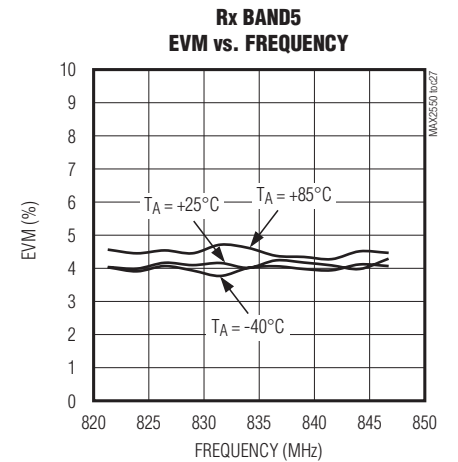
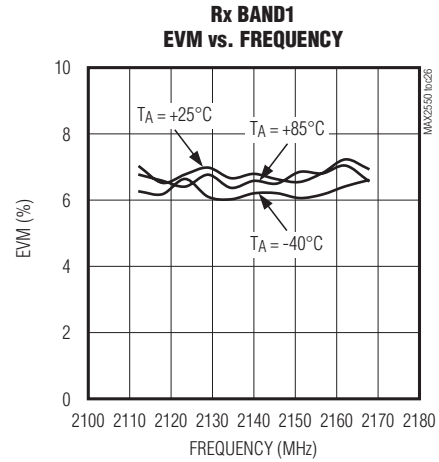
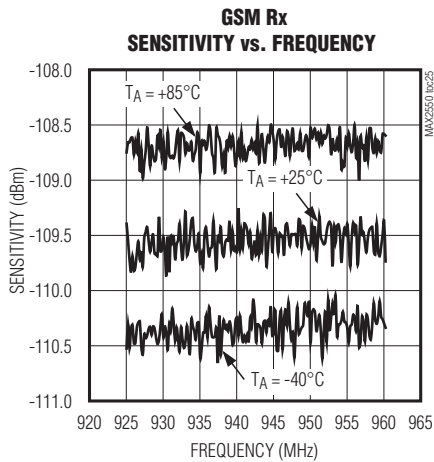
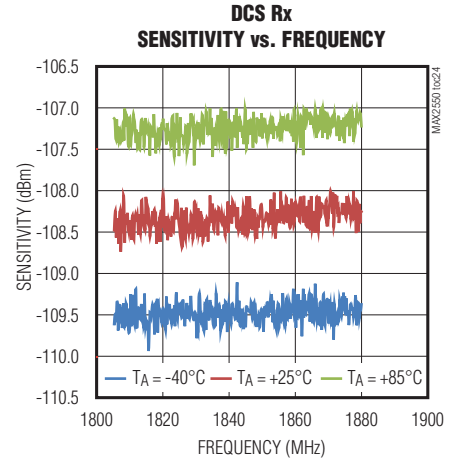
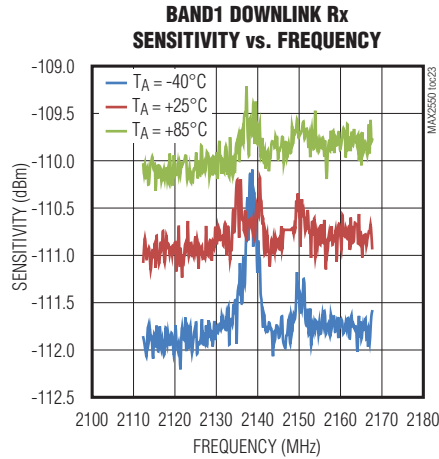
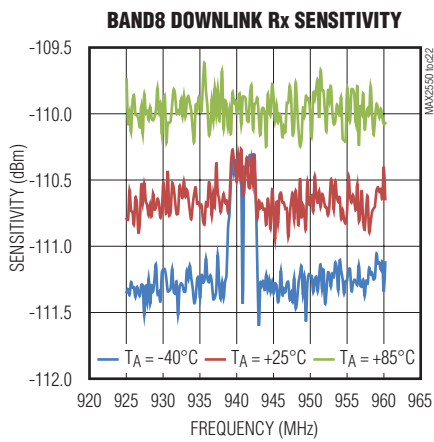

MAX2550

Band I, V, and VIII WCDMA Femtocell Transceiver with GSM Monitoring

Typical Operating Characteristics (continued)

(MAX2550 EV kit and MAX-PHY FPGA evaluation platform, $T_A = +25^\circ\text{C}$, unless otherwise noted. Registers set as described in Tables 20 and 21, $V_{CC_} = 3.3\text{V}$, $f_{\text{REFIN}} = 19.2\text{MHz}$, all sensitivity levels and blocker levels are antenna referred.)

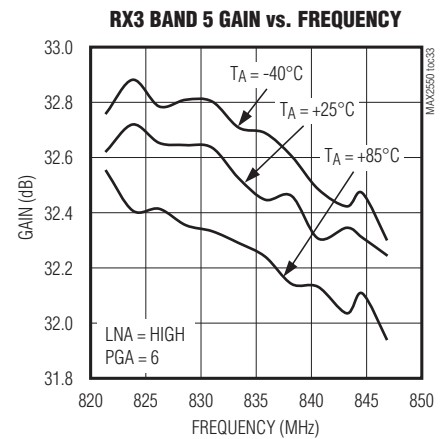
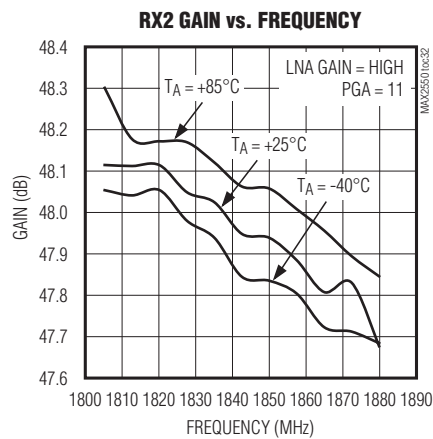
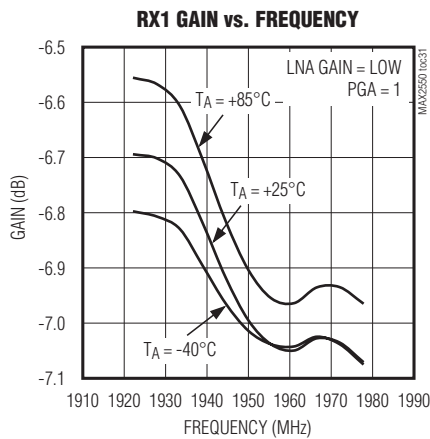
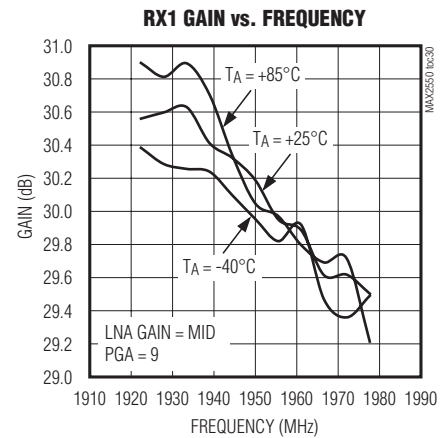
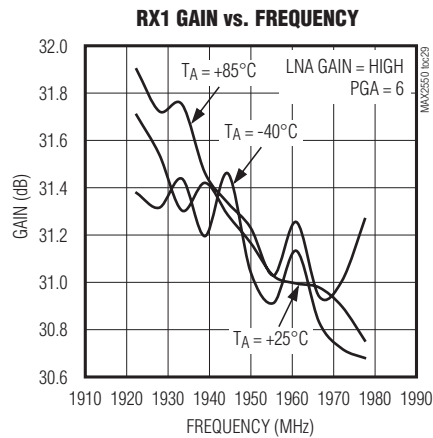
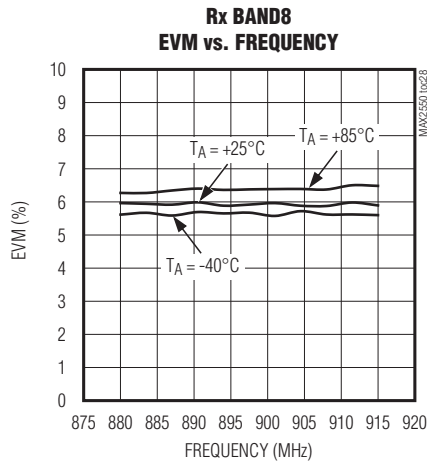

MAX2550

Band I, V, and VIII WCDMA Femtocell Transceiver with GSM Monitoring

Typical Operating Characteristics (continued)

(MAX2550 EV kit and MAX-PHY FPGA evaluation platform, $T_A = +25^\circ\text{C}$, unless otherwise noted. Registers set as described in Tables 20 and 21, $V_{CC_} = 3.3\text{V}$, $f_{\text{REFIN}} = 19.2\text{MHz}$, all sensitivity levels and blocker levels are antenna referred.)

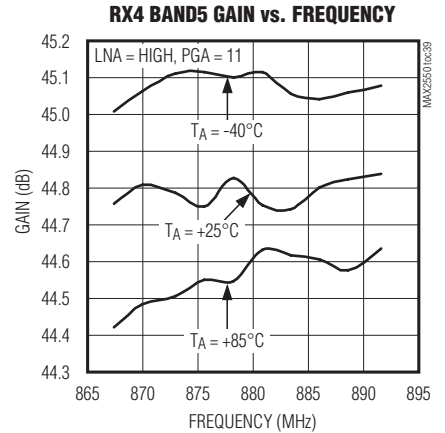
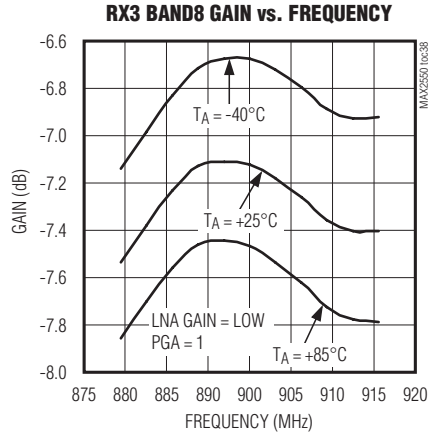
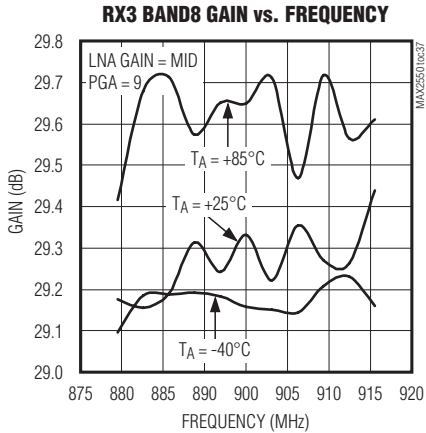
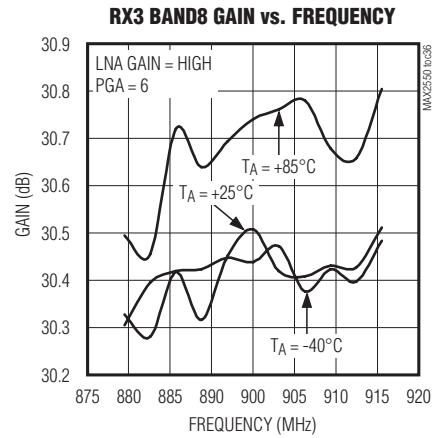
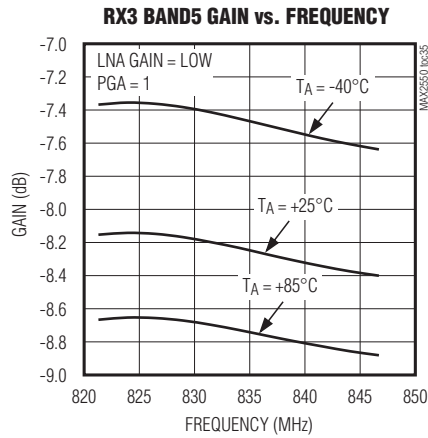
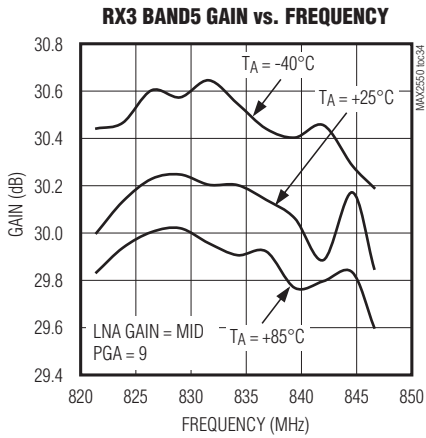

MAX2550

Band I, V, and VIII WCDMA Femtocell Transceiver with GSM Monitoring

Typical Operating Characteristics (continued)

(MAX2550 EV kit and MAX-PHY FPGA evaluation platform, $T_A = +25^\circ\text{C}$, unless otherwise noted. Registers set as described in Tables 20 and 21, $V_{CC_} = 3.3\text{V}$, $f_{\text{REFIN}} = 19.2\text{MHz}$, all sensitivity levels and blocker levels are antenna referred.)

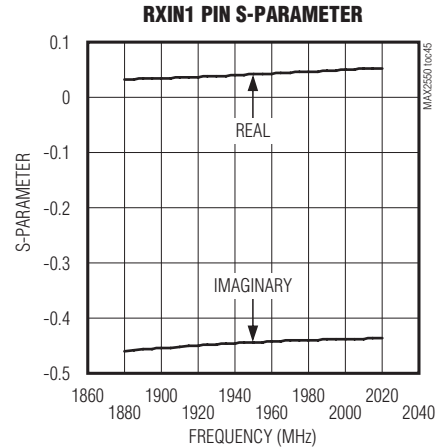
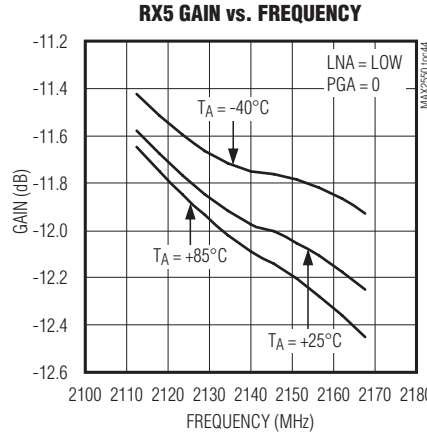
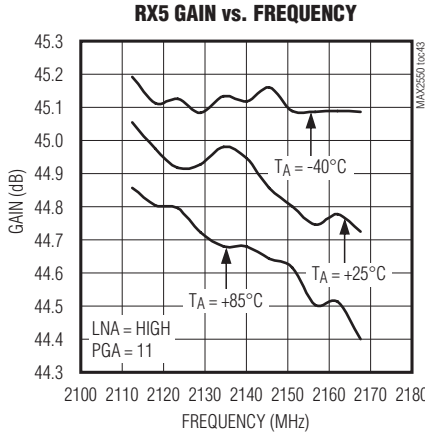
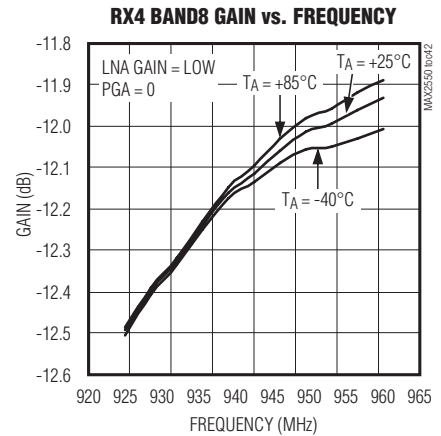
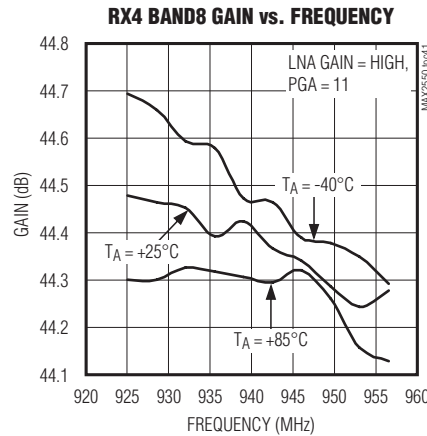
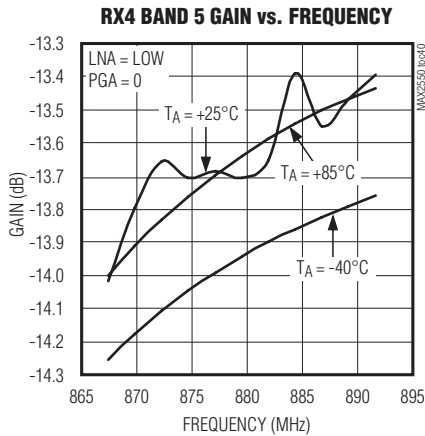

MAX2550

Band I, V, and VIII WCDMA Femtocell Transceiver with GSM Monitoring

Typical Operating Characteristics (continued)

(MAX2550 EV kit and MAX-PHY FPGA evaluation platform, $T_A = +25^\circ\text{C}$, unless otherwise noted. Registers set as described in Tables 20 and 21, $V_{CC_} = 3.3\text{V}$, $f_{\text{REFIN}} = 19.2\text{MHz}$, all sensitivity levels and blocker levels are antenna referred.)

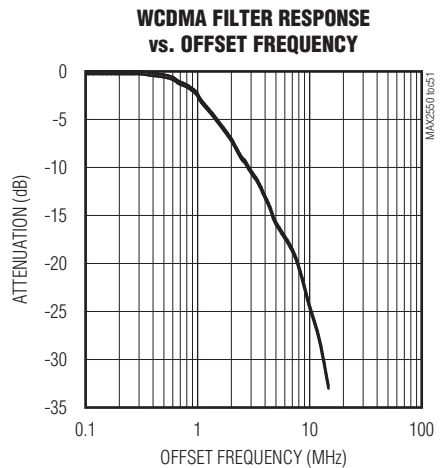
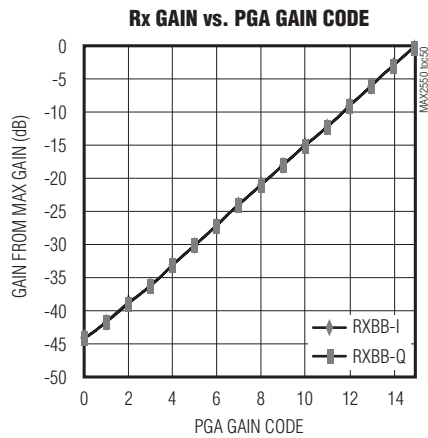
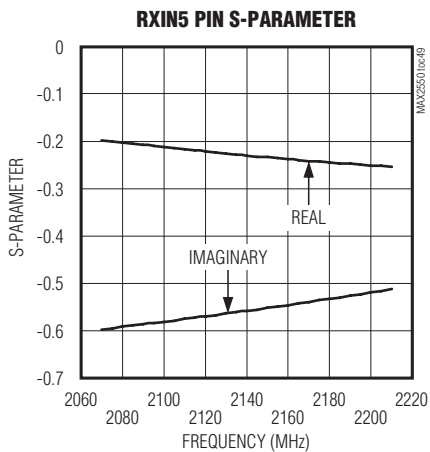
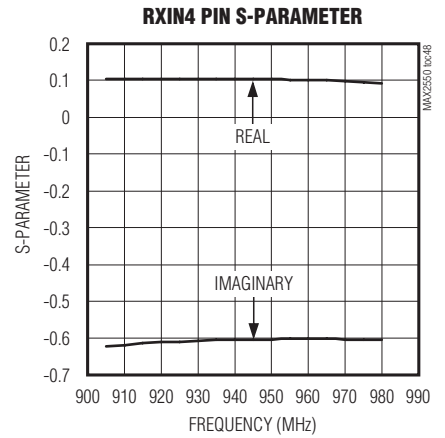
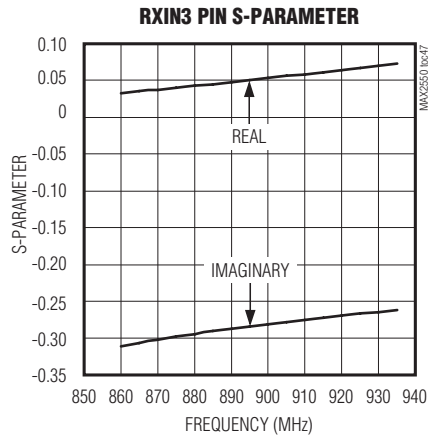
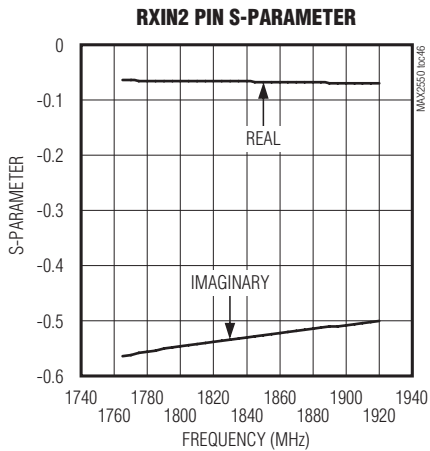

MAX2550

Band I, V, and VIII WCDMA Femtocell Transceiver with GSM Monitoring

Typical Operating Characteristics (continued)

(MAX2550 EV kit and MAX-PHY FPGA evaluation platform, $T_A = +25^\circ\text{C}$, unless otherwise noted. Registers set as described in Tables 20 and 21, $V_{CC_} = 3.3\text{V}$, $f_{\text{REFIN}} = 19.2\text{MHz}$, all sensitivity levels and blocker levels are antenna referred.)

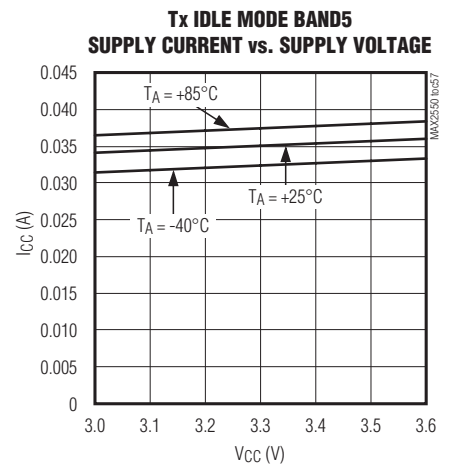
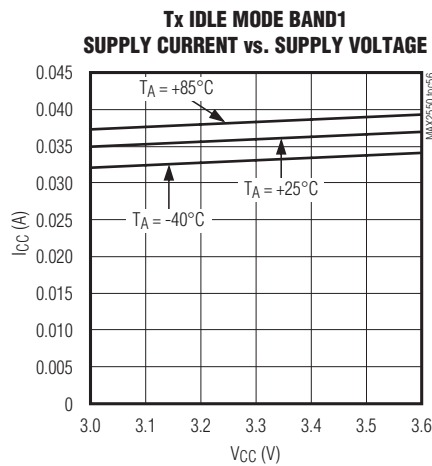
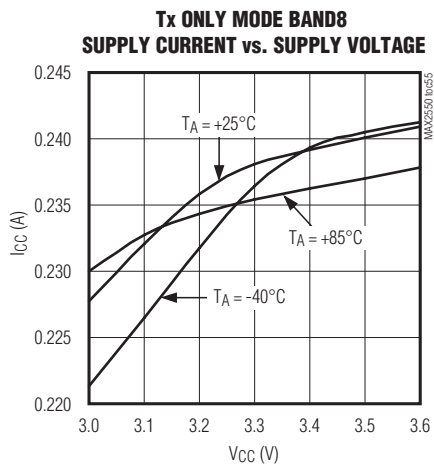
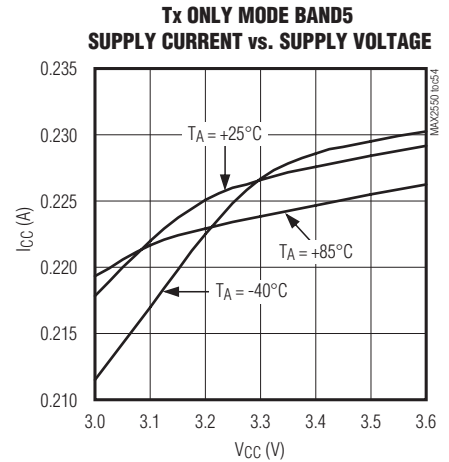
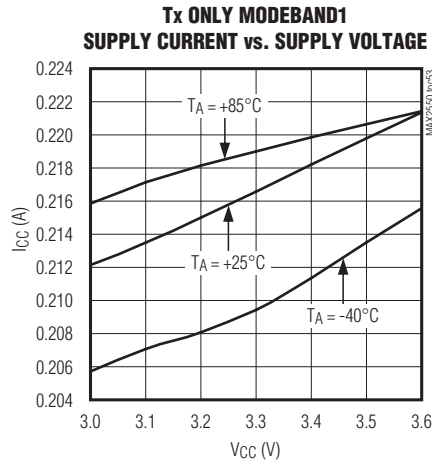
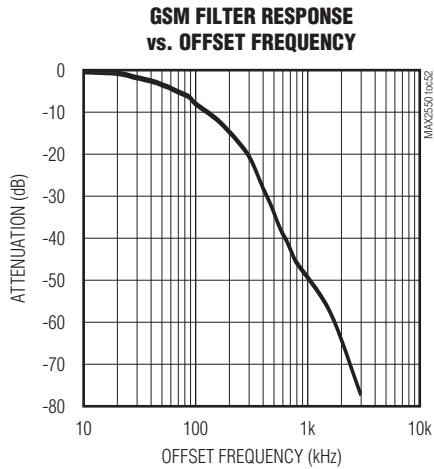

MAX2550

Band I, V, and VIII WCDMA Femtocell Transceiver with GSM Monitoring

Typical Operating Characteristics (continued)

(MAX2550 EV kit and MAX-PHY FPGA evaluation platform, $T_A = +25^\circ\text{C}$, unless otherwise noted. Registers set as described in Tables 20 and 21, $V_{CC_} = 3.3\text{V}$, $f_{\text{REFIN}} = 19.2\text{MHz}$, all sensitivity levels and blocker levels are antenna referred.)

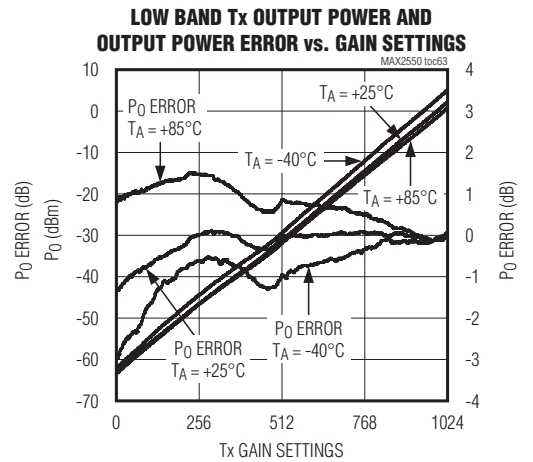
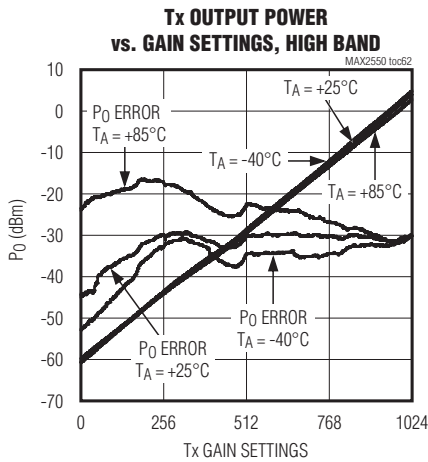
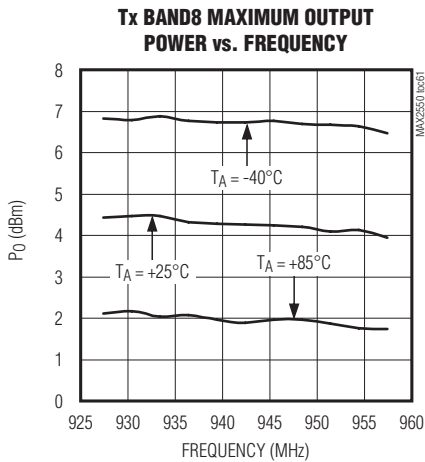
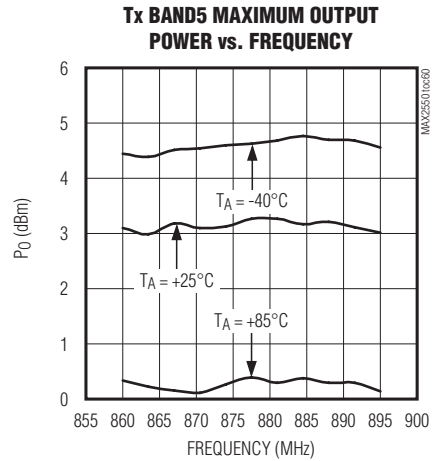
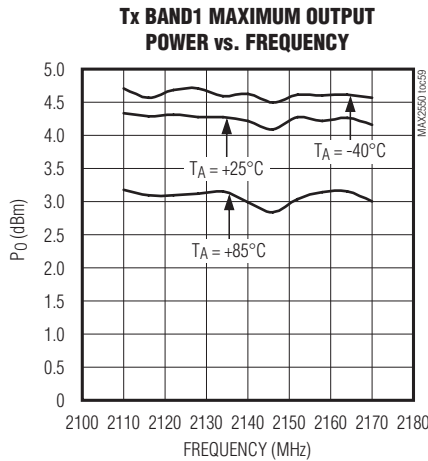
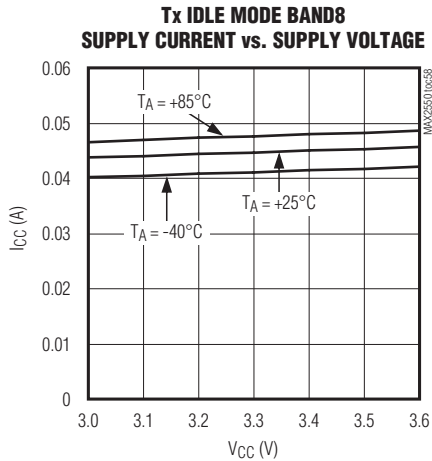

MAX2550

Band I, V, and VIII WCDMA Femtocell Transceiver with GSM Monitoring

Typical Operating Characteristics (continued)

(MAX2550 EV kit and MAX-PHY FPGA evaluation platform, $T_A = +25^\circ\text{C}$, unless otherwise noted. Registers set as described in Tables 20 and 21, $V_{CC_} = 3.3\text{V}$, $f_{\text{REFIN}} = 19.2\text{MHz}$, all sensitivity levels and blocker levels are antenna referred.)

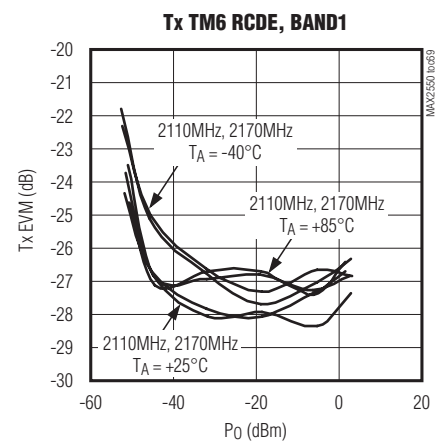
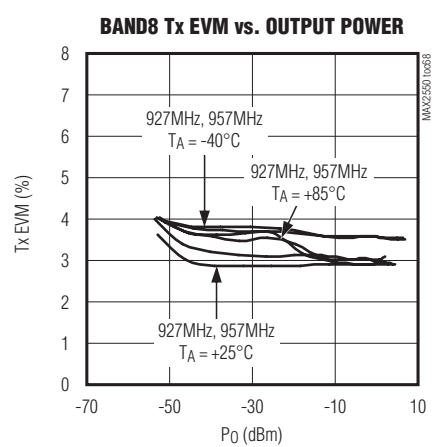
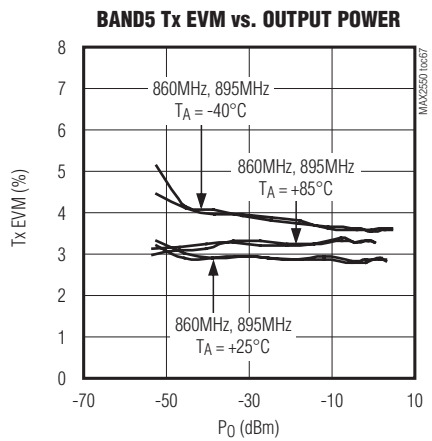
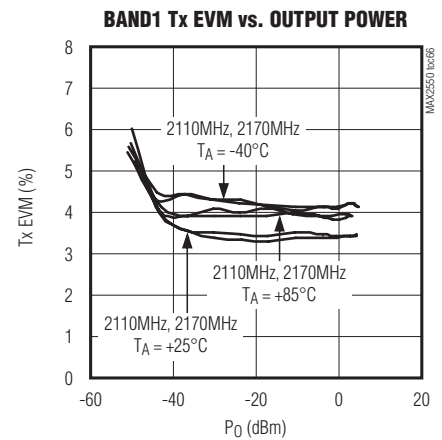
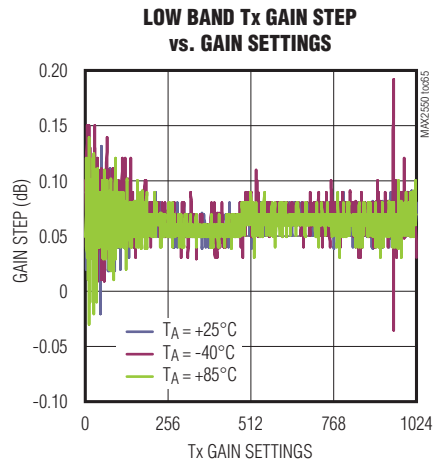
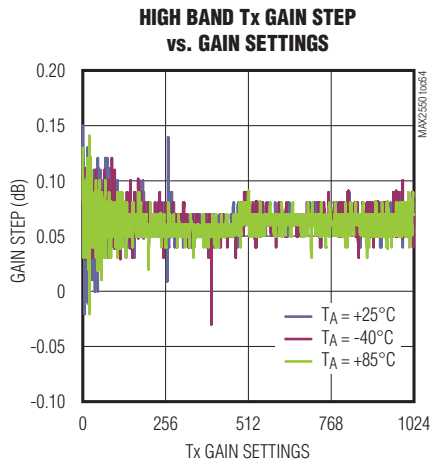

MAX2550

Band I, V, and VIII WCDMA Femtocell Transceiver with GSM Monitoring

Typical Operating Characteristics (continued)

(MAX2550 EV kit and MAX-PHY FPGA evaluation platform, $T_A = +25^\circ\text{C}$, unless otherwise noted. Registers set as described in Tables 20 and 21, $V_{CC_} = 3.3\text{V}$, $f_{\text{REFIN}} = 19.2\text{MHz}$, all sensitivity levels and blocker levels are antenna referred.)

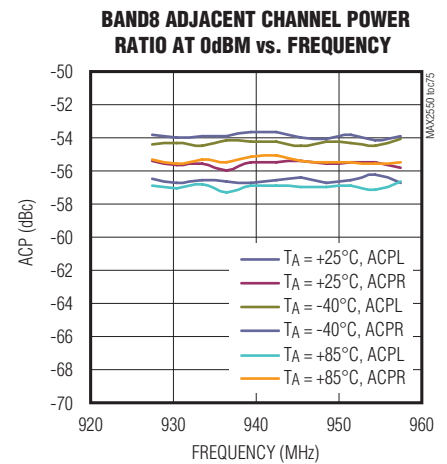
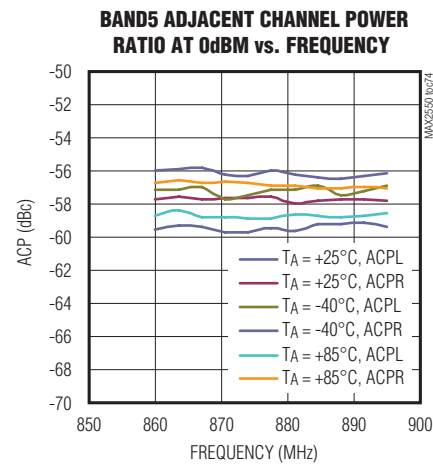
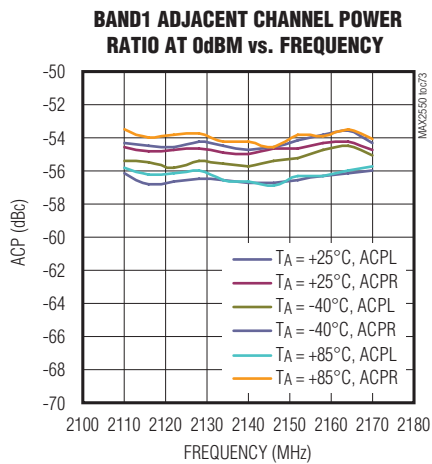
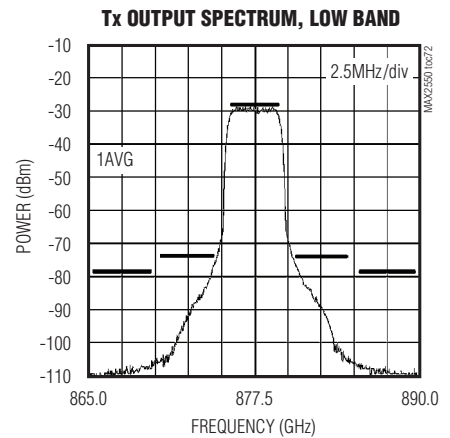
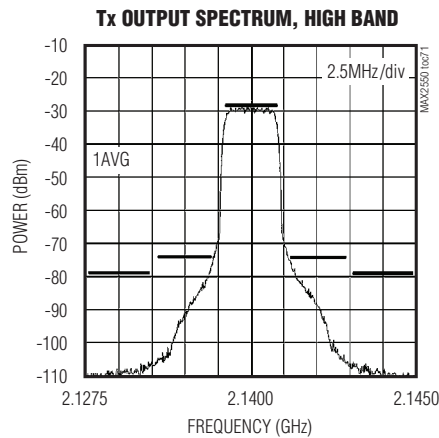
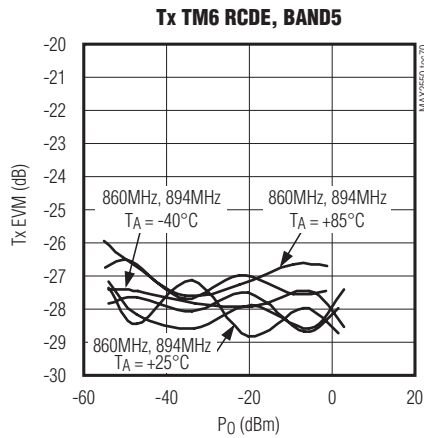

MAX2550

Band I, V, and VIII WCDMA Femtocell Transceiver with GSM Monitoring

Typical Operating Characteristics (continued)

(MAX2550 EV kit and MAX-PHY FPGA evaluation platform, $T_A = +25^\circ\text{C}$, unless otherwise noted. Registers set as described in Tables 20 and 21, $V_{CC_} = 3.3\text{V}$, $f_{\text{REFIN}} = 19.2\text{MHz}$, all sensitivity levels and blocker levels are antenna referred.)

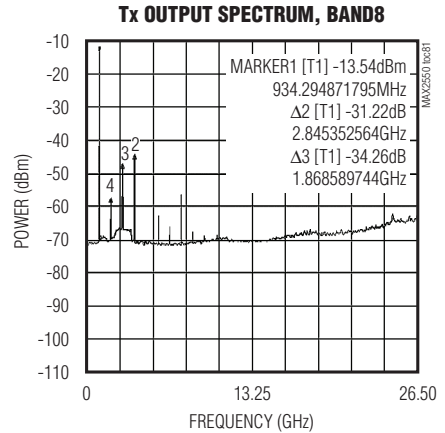
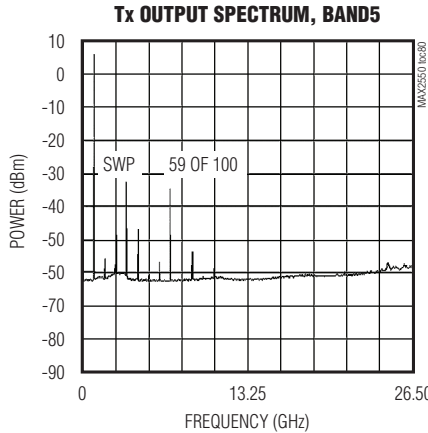
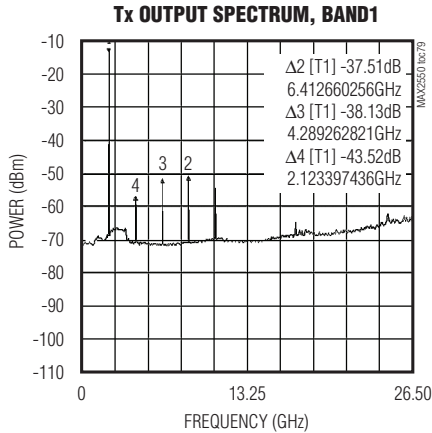
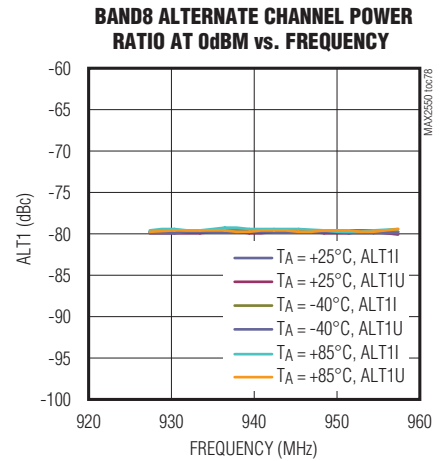
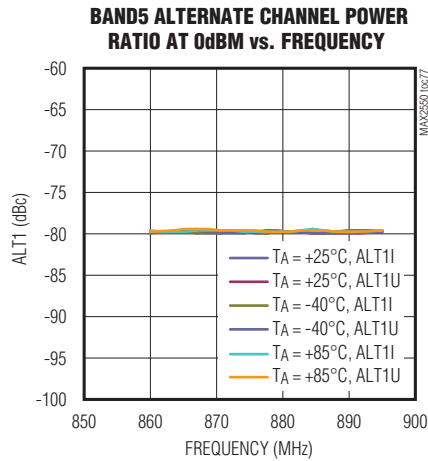
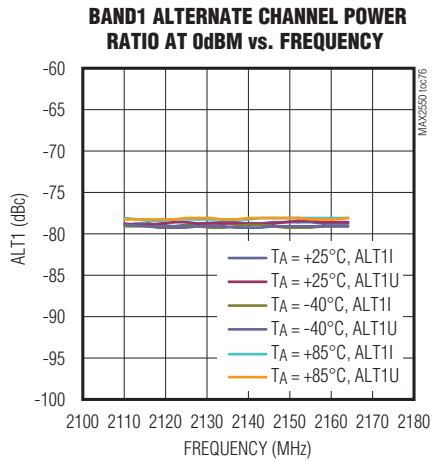

MAX2550

Band I, V, and VIII WCDMA Femtocell Transceiver with GSM Monitoring

Typical Operating Characteristics (continued)

(MAX2550 EV kit and MAX-PHY FPGA evaluation platform, $T_A = +25^\circ\text{C}$, unless otherwise noted. Registers set as described in Tables 20 and 21, $V_{CC_} = 3.3\text{V}$, $f_{\text{REFIN}} = 19.2\text{MHz}$, all sensitivity levels and blocker levels are antenna referred.)

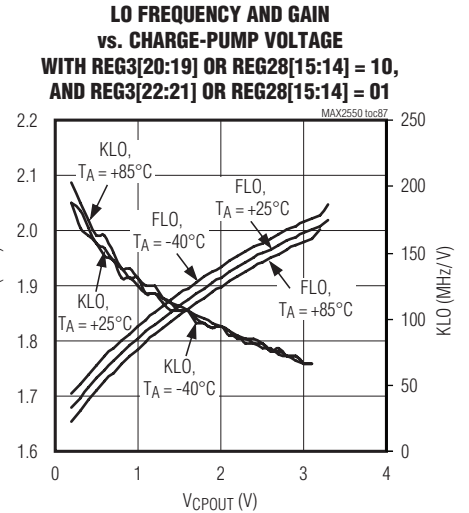
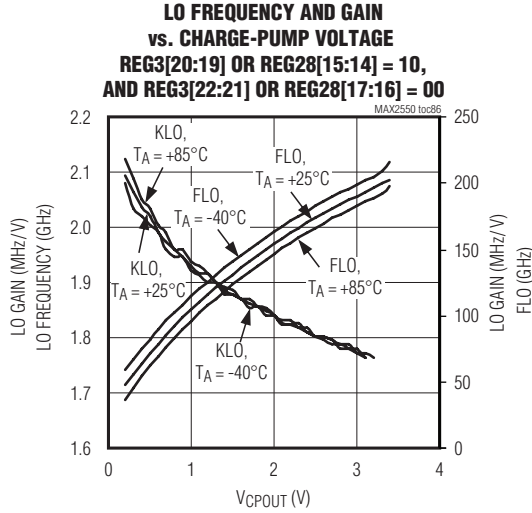
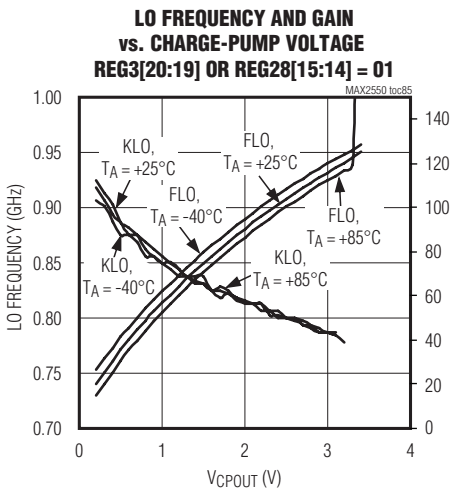
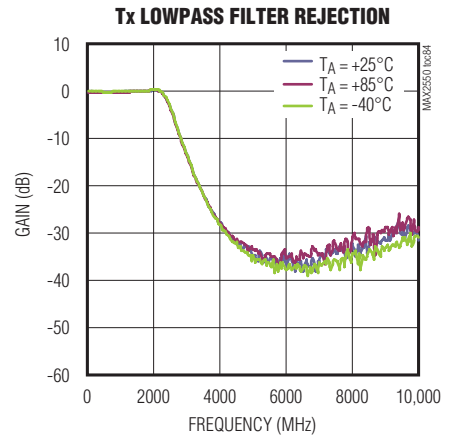
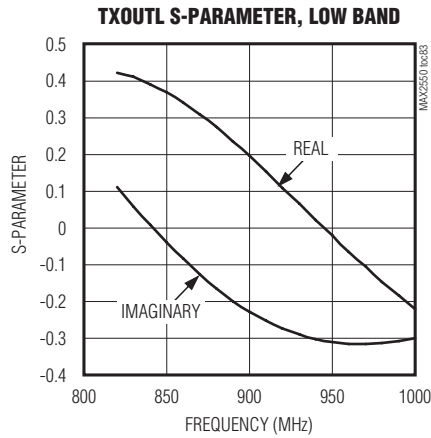
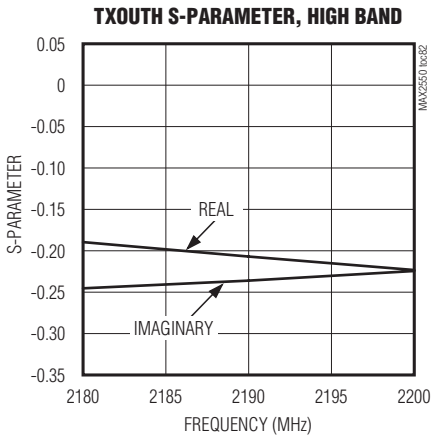

MAX2550

Band I, V, and VIII WCDMA Femtocell Transceiver with GSM Monitoring

Typical Operating Characteristics (continued)

(MAX2550 EV kit and MAX-PHY FPGA evaluation platform, $T_A = +25^\circ\text{C}$, unless otherwise noted. Registers set as described in Tables 20 and 21, $V_{CC-} = 3.3\text{V}$, $f_{\text{REFIN}} = 19.2\text{MHz}$, all sensitivity levels and blocker levels are antenna referred.)

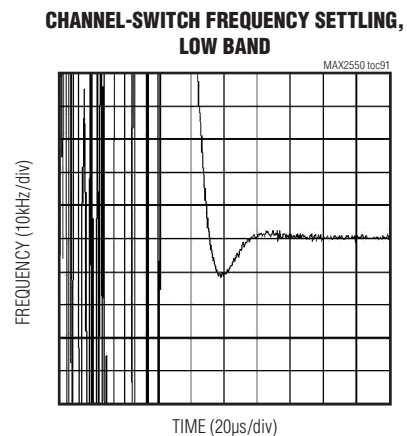
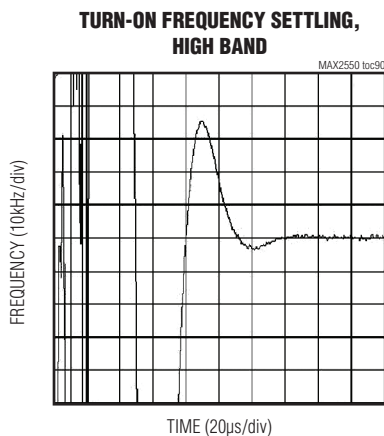
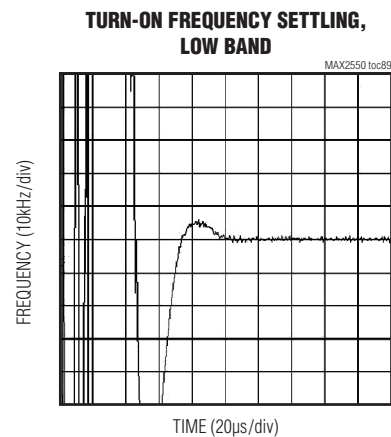
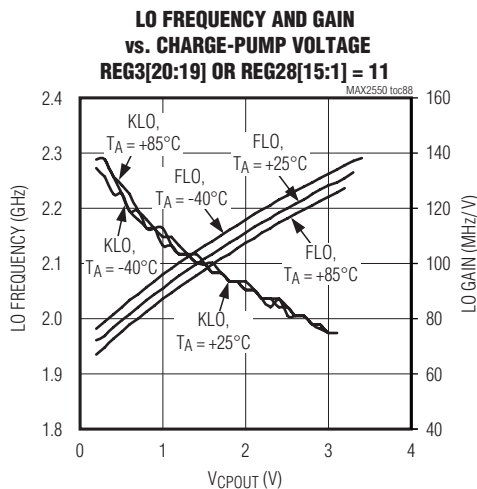

MAX2550

Band I, V, and VIII WCDMA Femtocell Transceiver with GSM Monitoring

Typical Operating Characteristics (continued)

(MAX2550 EV kit and MAX-PHY FPGA evaluation platform, $T_A = +25^\circ\text{C}$, unless otherwise noted. Registers set as described in Tables 20 and 21, $V_{CC_} = 3.3\text{V}$, $f_{\text{REFIN}} = 19.2\text{MHz}$, all sensitivity levels and blocker levels are antenna referred.)

CHANNEL-SWITCH FREQUENCY SETTLING, HIGH BAND

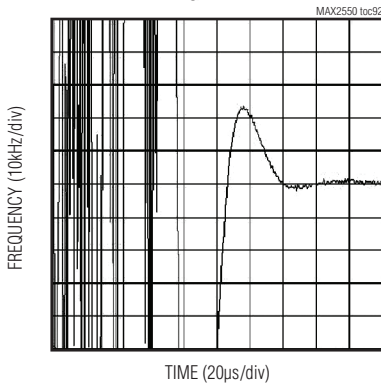

LO PHASE NOISE vs. FREQUENCY OFFSET HIGH BAND

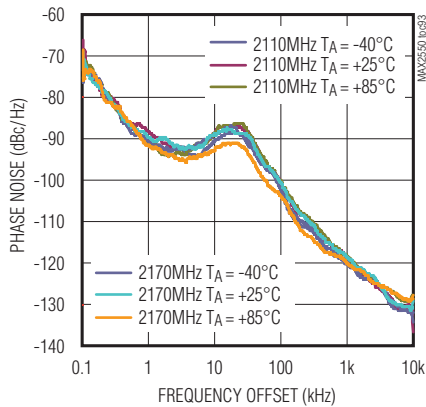

INTEGRATED PHASE NOISE vs. TEMPERATURE, HIGH BAND

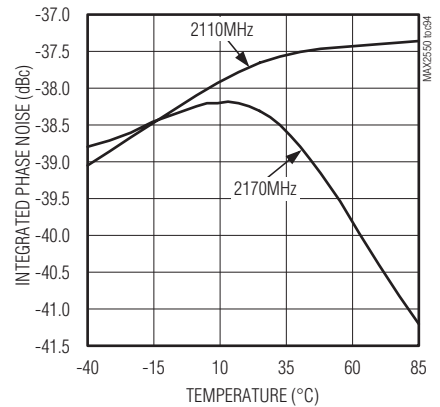

LO PHASE NOISE vs. FREQUENCY OFFSET LOW BAND

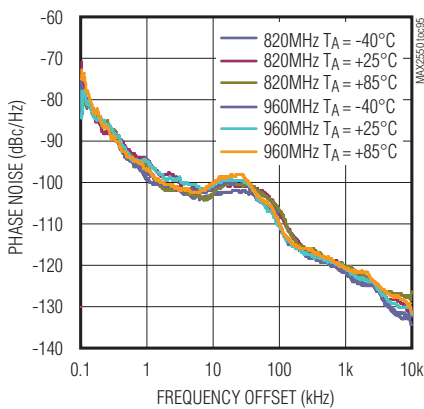

INTEGRATED PHASE NOISE, LOW BAND

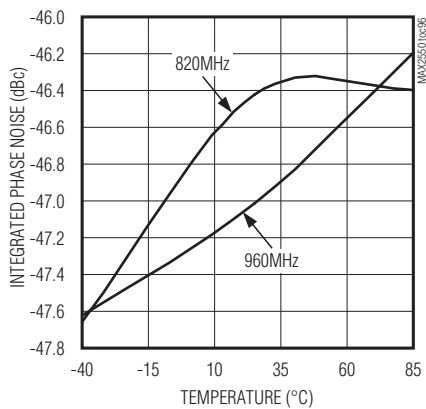

GAIN FROM TXOUTL TO OTHER RF PORTS vs. FREQUENCY

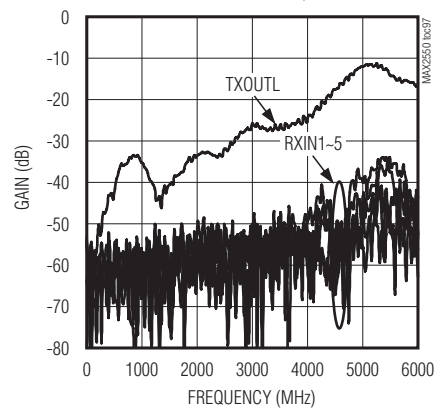

MAX2550

Band I, V, and VIII WCDMA Femtocell Transceiver with GSM Monitoring

Typical Operating Characteristics (continued)

(MAX2550 EV kit and MAX-PHY FPGA evaluation platform, $T_A = +25^\circ\text{C}$, unless otherwise noted. Registers set as described in Tables 20 and 21, $V_{CC_} = 3.3\text{V}$, $f_{\text{REFIN}} = 19.2\text{MHz}$, all sensitivity levels and blocker levels are antenna referred.)

GAIN FROM TXOUTL TO OTHER RF PORTS vs. FREQUENCY

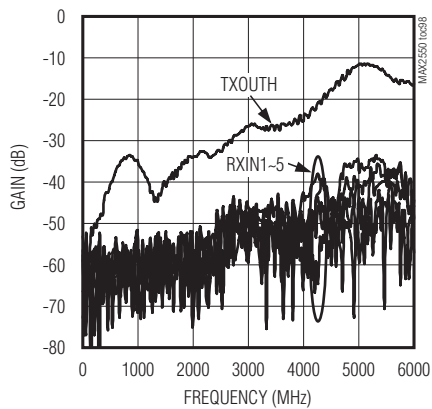

GAIN FROM ALL OTHER RF PORTS TO RXIN1 vs. FREQUENCY

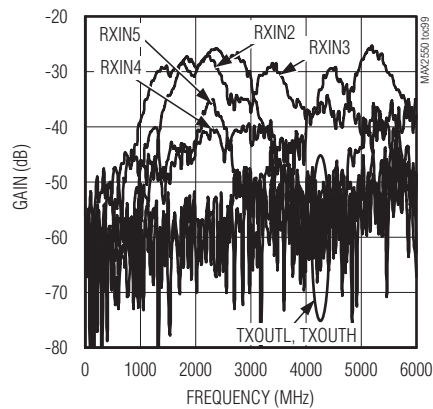

GAIN FROM ALL OTHER RF PORTS TO RXIN2 vs. FREQUENCY

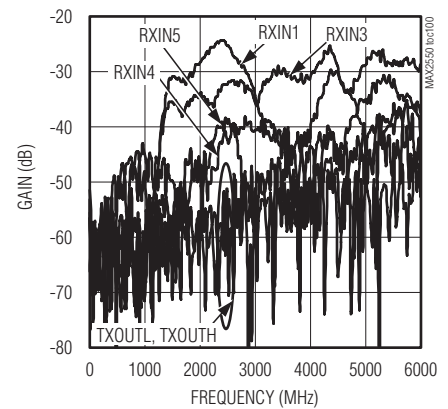

GAIN FROM ALL OTHER RF PORTS TO RXIN3 vs. FREQUENCY

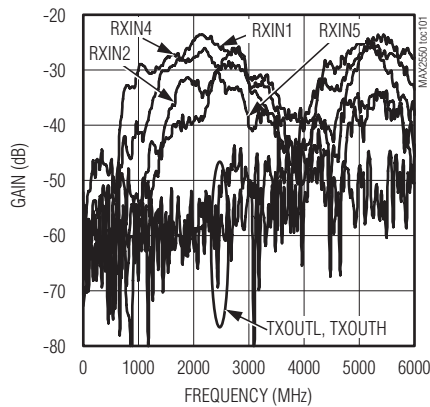

GAIN FROM ALL OTHER RF PORTS TO RXIN4 vs. FREQUENCY

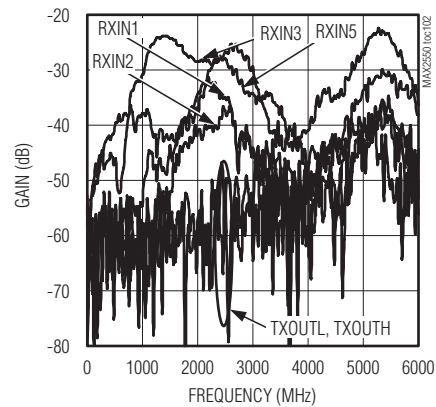

MAX2550

Band I, V, and VIII WCDMA Femtocell Transceiver with GSM Monitoring

Typical Operating Characteristics (continued)

(MAX2550 EV kit and MAX-PHY FPGA evaluation platform, $T_A = +25^\circ\text{C}$, unless otherwise noted. Registers set as described in Tables 20 and 21, $V_{CC_} = 3.3\text{V}$, $f_{\text{REFIN}} = 19.2\text{MHz}$, all sensitivity levels and blocker levels are antenna referred.)

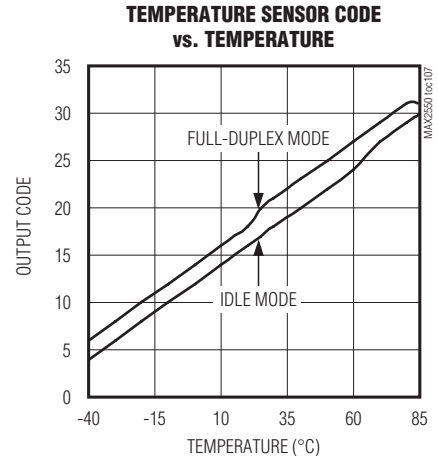
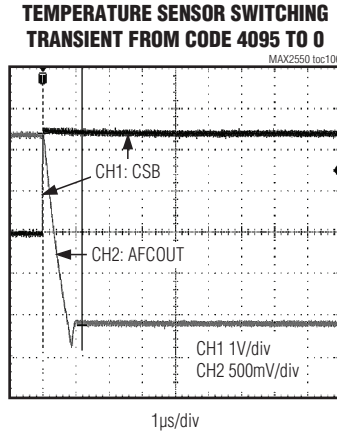
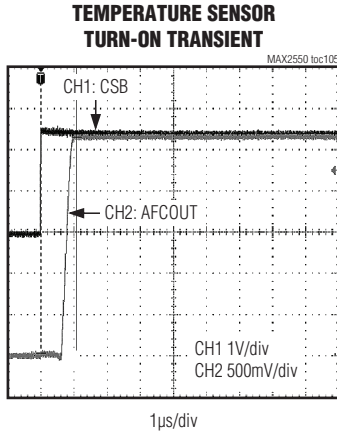
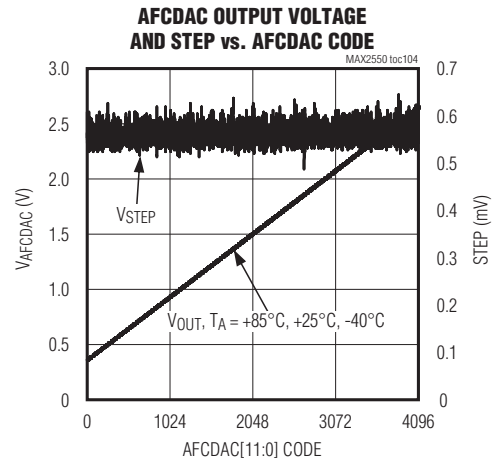
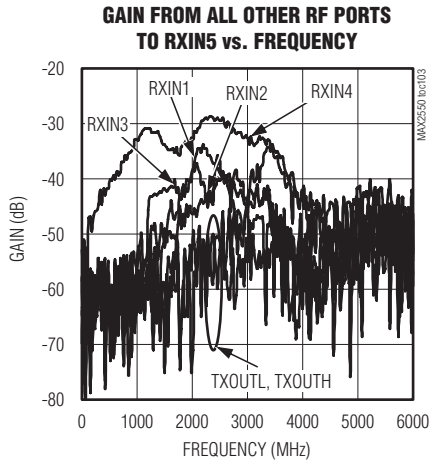

MAX2550

Band I, V, and VIII WCDMA Femtocell Transceiver with GSM Monitoring

Pin Configuration

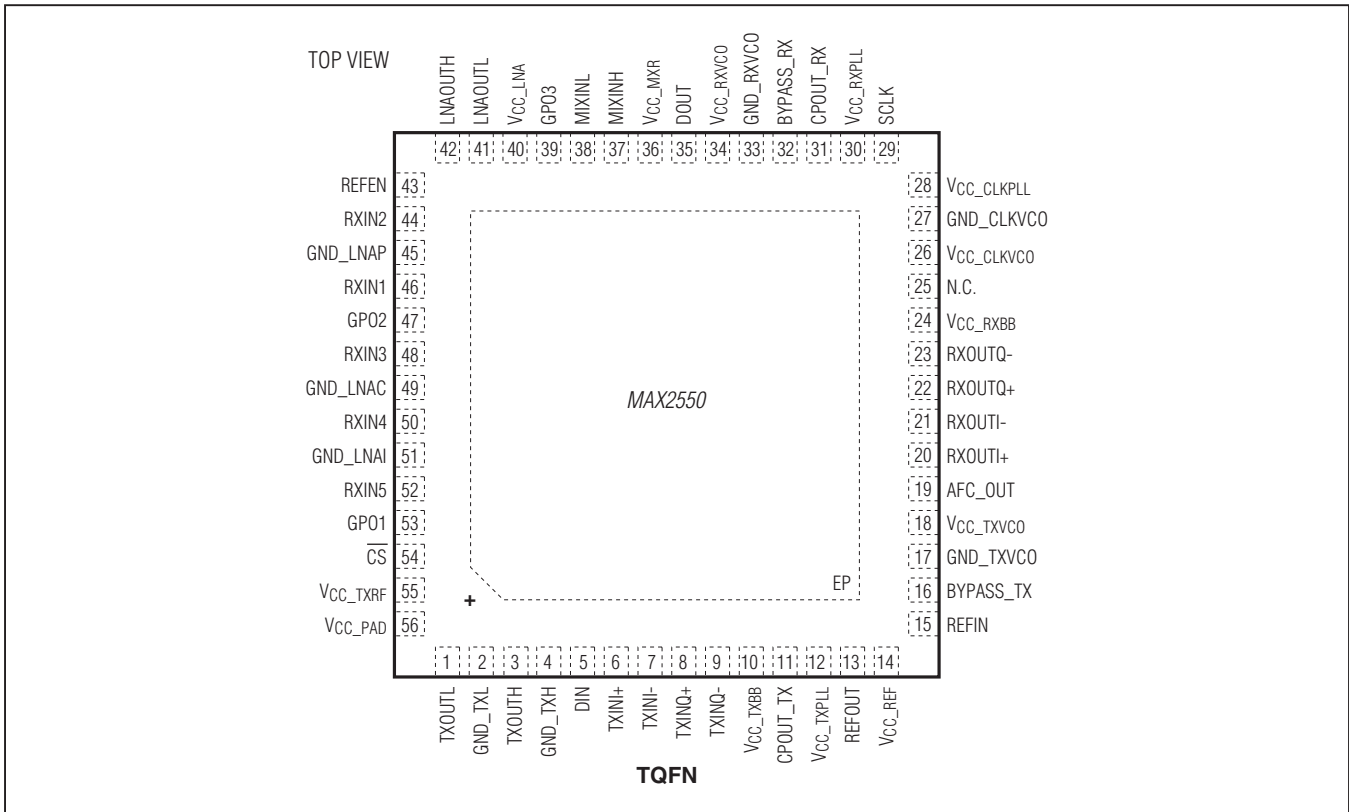

Pin Description

PIN	NAME	FUNCTION
1	TXOUTL	Low-Band TXRF Output. Internally matched to 50Ω over the band of operation.
2	GND_TXL	Tx Ground. Connect directly to ground plane.
3	TXOUTH	High-Band TXRF Output. Internally matched to 50Ω over the band of operation.
4	GND_TXH	High-Band Tx Output Ground. Connect directly to ground plane.
5	DIN	Data Input of the 4-Wire Serial Interface
6	TXINI+	Transmitter Noninverting In-Phase Input. Accepts baseband sigma-delta modulated digital bit streams. Connect directly to the baseband processor.
7	TXINI-	Transmitter Inverting In-Phase Input. Accepts baseband sigma-delta modulated digital bit streams. Connect directly to the baseband processor.

MAX2550

Band I, V, and VIII WCDMA Femtocell Transceiver with GSM Monitoring

Pin Description (continued)

PIN	NAME	FUNCTION
8	TXINQ+	Transmitter Noninverting Quadrature Input. Accepts baseband sigma-delta modulated digital bit streams. Connect directly to the baseband processor.
9	TXINQ-	Transmitter Inverting Quadrature Input. Accepts baseband sigma-delta modulated digital bit streams. Connect directly to the baseband processor.
10	V _{CC_TXBB}	Baseband Tx Path Supply. Connect to a regulated supply voltage. Bypass each supply to the PCB ground plane with a capacitor placed as close as possible to the pin. Do not share ground vias among multiple bypass capacitors.
11	CPOUT_TX	Charge-Pump Output for Tx Synthesizer. Also used as the tuning voltage for Tx VCO. Connect to an external loop filter.
12	V _{CC_TXPLL}	Tx Synthesizer Supply. Connect to a regulated supply voltage. Bypass each supply pin to the PCB ground plane with a capacitor placed as close as possible to the pin. Do not share ground vias among multiple bypass capacitors.
13	REFOUT	Reference Clock Buffer Output. Configurable by the REFEN pin and SPI. See the <i>REFOUT Functionality</i> section for details.
14	V _{CC_REF}	Reference Buffer Supply. Connect to a regulated supply voltage. Bypass each supply pin to the PCB ground plane with a capacitor placed as close as possible to the pin. Do not share ground vias among multiple bypass capacitors.
15	REFIN	Reference Input Pin. Connected to TCXO. Requires a DC-blocking capacitor (1nF).
16	BYPASS_TX	Tx VCO Bias Bypass. Bypass to ground with a 470nF capacitor as close as possible to the pin.
17	GND_TXVCO	Tx VCO Ground. Connect to the PCB ground plane with a separate via.
18	V _{CC_TXVCO}	Tx VCO Supply. Connect to a regulated supply voltage. Bypass each supply pin to the PCB ground plane with a capacitor placed as close as possible to the pin. Do not share ground vias among multiple bypass capacitors.
19	AFC_OUT	AFC DAC Output. The DAC is controlled by the register TXLO_AFCDAC (Table 43).
20	RXOUTI+	Receiver Noninverting In-Phase Output. Digital sigma-delta modulated LVDS output. Connect directly to the baseband processor.
21	RXOUTI-	Receiver Inverting In-Phase Output. Digital sigma-delta modulated LVDS output. Connect directly to the baseband processor.
22	RXOUTQ+	Receiver Noninverting Quadrature Output. Digital sigma-delta modulated LVDS output. Connect directly to the baseband processor.
23	RXOUTQ-	Receiver Inverting Quadrature Output. Digital sigma-delta modulated LVDS output. Connect directly to the baseband processor.
24	V _{CC_RXBB}	Baseband Rx Path Supply. Regulated Power-Supply Input. Connect to a regulated supply voltage. Bypass each supply pin to the PCB ground plane with a capacitor placed as close as possible to the pin. Do not share ground vias among multiple bypass capacitors.
25	N.C.	No Connection. Leave unconnected.
26	V _{CC_CLKVCO}	Clock Generation VCO Supply. Connect to a regulated supply voltage. Bypass each supply pin to the PCB ground plane with a capacitor placed as close as possible to the pin. Do not share ground vias among multiple bypass capacitors.

MAX2550

Band I, V, and VIII WCDMA Femtocell Transceiver with GSM Monitoring

Pin Description (continued)

PIN	NAME	FUNCTION
27	GND_CLKVCO	Clock Generation Synthesizer Ground. Connect clock generation synthesizer ground to the PCB ground plane with a separate via.
28	V _{CC} _CLKPLL	Clock Generation Synthesizer Supply. Connect to a regulated supply voltage. Bypass each supply pin to the PCB ground plane with a capacitor placed as close as possible to the pin. Do not share ground vias among multiple bypass capacitors.
29	SCLK	SPI Interface Clock Input. Data is clocked in to the serial data input on the rising edge of SCLK. See Figure 4 for details.
30	V _{CC} _RXPLL	Rx Synthesizer Supply. Connect to a regulated supply voltage. Bypass each supply pin to the PCB ground plane with a capacitor placed as close as possible to the pin. Do not share ground vias among multiple bypass capacitors.
31	CPOUT_RX	Rx Synthesizer Charge-Pump Output. Also used as the tuning voltage for Rx VCO. Connect to an external loop filter.
32	BYPASS_RX	Rx VCO Bias Bypass. Bypass to ground with a 470nF capacitor as close as possible to the pin.
33	GND_RXVCO	Rx VCO Ground. Connect ground to the PCB ground plane with a separate via.
34	V _{CC} _RXVCO	Rx VCO Supply. Connect to a regulated supply voltage. Bypass each supply pin to the PCB ground plane with a capacitor placed as close as possible to the pin. Do not share ground vias among multiple bypass capacitors.
35	DOUT	SPI Data Output
36	V _{CC} _MXR	Rx Mixer Supply. Connect to a regulated supply voltage. Bypass each supply pin to the PCB ground plane with a capacitor placed as close as possible to the pin. Do not share ground vias among multiple bypass capacitors.
37	MIXINH	High-Band Rx Mixer Input. RF input to mixer from an external filter (optional). Internally DC-blocked and matched to 50Ω.
38	MININL	Low-Band Rx Mixer Input. RF input to mixer from an external filter (optional). Internally DC-blocked and matched to 50Ω.
39	GPO3	General-Purpose Output. Controlled by register 7 (Table 20). GPO3 can also be configure as a PLL lock-detect output.
40	V _{CC} _LNA	LNA Supply. Connect to a regulated supply voltage. Bypass each supply pin to the PCB ground plane with a capacitor placed as close as possible to the pin. Do not share ground vias among multiple bypass capacitors.
41	LNAOUTL	Low-Band LNA Output. RF output from LNA 3 to external SAW filter. Internally DC-blocked and matched to 50Ω.
42	LNAOUTH	High-Band LNA Output. RF Output from LNA 1 to an external SAW filter. Internally DC-blocked and matched to 50Ω.
43	REFEN	Configuration for REFOUT. When REFEN = 0, REFOUT can be configured for CMOS or low-voltage output by the SPI interface. See the <i>REFOUT Functionality</i> section. When REFEN = 1, REFOUT is configured as REFEN buffer with CMOS output.
44	RXIN2	Low-Noise Amplifier Input 2. Requires AC-coupling and external matching.
45	GND_LNAP	PCS LNA Ground. Connect directly to ground plane.
46	RXIN1	Low-Noise Amplifier Input 1. Requires AC-coupling and external matching.
47	GPO2	General-Purpose Output. Controlled by register 7<3:2>.

MAX2550

Band I, V, and VIII WCDMA Femtocell Transceiver with GSM Monitoring

Pin Description (continued)

PIN	NAME	FUNCTION
48	RXIN3	Low-Noise Amplifier Input 3. Requires AC-coupling and external matching.
49	GND_LNAC	Ground for Cellular LNA. Connect directly to the ground plane.
50	RXIN4	Low-Noise Amplifier Input 4. Requires AC-coupling and external matching.
51	GND_LNAI	IMT LNA Ground. Connect directly to the ground plane.
52	RXIN5	Low-Noise Amplifier Input 5. Requires AC-coupling and external matching.
53	GPO1	General-Purpose Output. Controlled by register 23<25:24>.
54	\overline{CS}	Serial-Interface Chip Select. See Figure 4.
55	V _{CC_TXRF}	Tx Upconverter Supply. Connect to a regulated supply voltage. Bypass each supply pin to the PCB ground plane with a capacitor placed as close as possible to the pin. Do not share ground vias among multiple bypass capacitors.
56	V _{CC_PAD}	PA Driver Supply. Connect to a regulated supply voltage. Bypass each supply pin to the PCB ground plane with a capacitor placed as close as possible to the pin. Do not share ground vias among multiple bypass capacitors.
—	EP	Exposed Pad. Connect to a large ground plane to maximize thermal performance.

Detailed Description

Quad RF Inputs

The MAX2550 features five independent RF inputs. RXIN1 and RXIN3 are used for receiving WCDMA Bands I, V, VI, and VIII. Bands I, V, VI, and VIII WCDMA/PCS downlink can be monitored (network listen) by programming the part to receive through the RXIN4 and RXIN5 inputs. RXIN2 can be used to monitor Band III. This allows the base station to monitor surrounding cells to select the best operating conditions (transmit power, codes, frequency, capacity, etc.)

REFOUT Functionality

The MAX2550 features a reference oscillator buffered output that is configurable by the REFEN input and Register 29. REFOUT can be configured as CMOS or as a low-voltage output. Table 2 lists all REFOUT configurations.

Receiver System Gain Control

The device features programmable-gain LNAs and programmable variable-gain baseband amplifiers, allowing the system gain to be entirely controlled by the serial interface. RX1, RX2, RX3, and RX5 have three possible gain states: high gain, medium gain, and low gain. RX4

has high and low gain modes. The gain state of the LNA in operation is programmed by the LNAGAIN bits in the RX_GAIN[15:14] register. Each LNA requires an external matching network to optimize system sensitivity. Table 3 provides S11 for each LNA input over the specified band of operation, Table 4 provides S11 of RXIN1 and RXIN3 LNA output, and Table 5 provides S11 of the mixer input. The receiver also features a separate dedicated receive path for the 1930MHz to 1995MHz band that enables monitoring.

The baseband amplifiers has 16 possible gain states with each LSB providing a gain step of 3dB. The gain state of the baseband amplifiers is programmed by the PGAGAIN bits in the RX_GAIN[11:8] register. The dynamic range of the data converters when using the recommended sampling rates is sufficient to allow for minimal switching of system gain over varying input signal power. Tables 6 and 7 provide suggested LNA and PGA settings for various input signal power ranges. Two possible LNA/PGA gain settings are provided for the uplink band. Case 1 (Table 6) allows for 3GPP TS25.104 compliance under all conditions while case 2 (Table 7) allows best sensitivity, but compromises adjacent channel selectivity and inter-modulation in high-gain LNA mode.

MAX2550

Band I, V, and VIII WCDMA Femtocell Transceiver with GSM Monitoring

Table 1. RF Input/Output Frequency Range

PIN	FUNCTION	FREQUENCY RANGE (MHz)
RXIN1	Band I WCDMA uplink Rx	1920 to 1980
RXIN2	Band III DCS monitor	1805 to 1880
RXIN3	Band V uplink WCDMA/GSM Band VI WCDMA uplink Band VIII uplink WCDMA	824 to 849 830 to 840 880 to 915
RXIN4	Band V downlink WCDMA/GSM monitor Band VI WCDMA monitor Band VIII downlink WCDMA/GSM monitor	865 to 894 875 to 885 925 to 960
RXIN5	Band I WCDMA monitor	2110 to 2170
TXOUTL	Band V WCDMA downlink Tx Band VI WCDMA downlink Tx Band VIII WCDMA downlink Tx	865 to 894 875 to 885 925 to 960
TXOUTH	Band I WCDMA downlink Tx	2110 to 2170

Table 2. REFOUT Output Configurations

INPUT			OUTPUT
REFEN INPUT	REFIN_ENOUT3 (TXLO_REF<14>)	REFOUT_LV_CMOS_SEL (TXLO_REF<23>)	OUTPUT TYPE
0	0	X	Off
	1	0	CMOS
1	X	1	Low voltage
		X	CMOS

Table 3. Typical RXIN1 (High Gain) S11 Parameters ($V_{CC_} = +3.3V$, $T_A = +25^{\circ}C$)

FREQUENCY (MHz)	S11 REAL	S11 IMAGINARY
1880	34.3	-40.1
1885	34.4	-40.0
1890	34.6	-40.0
1895	34.7	-40.0
1900	34.8	-39.9
1905	34.9	-39.9
1910	35.0	-39.9
1915	35.1	-39.8
1920	35.3	-39.8
1925	35.4	-39.8
1930	35.5	-39.8
1935	35.6	-39.8
1940	35.7	-39.8
1945	35.8	-39.8
1950	35.9	-39.8

FREQUENCY (MHz)	S11 REAL	S11 IMAGINARY
1955	36.0	-39.8
1960	36.1	-39.8
1965	36.2	-39.8
1970	36.3	-39.8
1975	36.4	-39.9
1980	36.5	-39.9
1985	36.6	-39.9
1990	36.6	-39.9
1995	36.7	-40.0
2000	36.8	-40.0
2005	36.9	-40.0
2010	36.9	-40.1
2015	37.0	-40.1
2020	37.1	-40.2

MAX2550

Band I, V, and VIII WCDMA Femtocell Transceiver with GSM Monitoring

Table 4. Typical RXIN3 (High Gain) S11 Parameters ($V_{CC_} = +3.3V$, $T_A = +25^{\circ}C$)

FREQUENCY (MHz)	S11 REAL	S11 IMAGINARY
1765	23.4	-38.9
1770	23.5	-38.8
1775	23.7	-38.6
1780	23.8	-38.5
1785	23.9	-38.4
1790	24.1	-38.3
1795	24.2	-38.2
1800	24.3	-38.1
1805	24.4	-38.0
1810	24.6	-37.9
1815	24.7	-37.8
1820	24.8	-37.7
1825	24.9	-37.6
1830	25.0	-37.5
1835	25.1	-37.4
1840	25.2	-37.3
1845	25.3	-37.2
1850	25.4	-37.1
1855	25.5	-37.1
1860	25.6	-37.0
1865	25.7	-36.9
1870	25.8	-36.8
1875	25.9	-36.7
1880	26.0	-36.6
1885	26.1	-36.5
1890	26.1	-36.4
1895	26.2	-36.3
1900	26.3	-36.2
1905	26.4	-36.2
1910	26.5	-36.1
1915	26.6	-36.0
1920	26.6	-35.9

Table 5. Typical RXIN4 (High Gain) S11 Parameters ($V_{CC_} = +3.3V$, $T_A = +25^{\circ}C$)

FREQUENCY (MHz)	S11 REAL	S11 IMAGINARY
840	22.0	-53.8
845	22.5	-53.6
850	22.9	-53.4
855	23.3	-53.3
860	23.7	-53.2
865	24.1	-53.1
870	24.3	-53.0
875	24.6	-53.0
880	24.8	-52.9
885	24.9	-52.9
890	25.0	-52.8
895	25.1	-52.8
900	25.1	-52.7
905	25.3	-52.3
910	25.6	-52.2
915	25.9	-52.1
920	26.2	-52.0
925	26.4	-52.0
930	26.5	-51.9
935	26.6	-51.9
940	26.7	-51.8
945	26.8	-51.8
950	26.8	-51.7
955	26.8	-51.6
960	26.8	-51.5
965	26.7	-51.4
970	26.6	-51.2
975	26.5	-51.1
980	26.4	-50.9

MAX2550

Band I, V, and VIII WCDMA Femtocell Transceiver with GSM Monitoring

Table 6. Typical RXIN5 (High Gain) S11 Parameters ($V_{CC_} = +3.3V$, $T_A = +25^{\circ}C$)

FREQUENCY (MHz)	S11 REAL	S11 IMAGINARY
2070	16.9	-33.3
2075	16.9	-33.1
2080	17.0	-32.9
2085	17.0	-32.7
2090	17.0	-32.5
2095	17.1	-32.3
2100	17.1	-32.2
2105	17.1	-32.0
2110	17.2	-31.8
2115	17.2	-31.6
2120	17.3	-31.4
2125	17.3	-31.2
2130	17.3	-31.0
2135	17.4	-30.8
2140	17.4	-30.6
2145	17.5	-30.4

FREQUENCY (MHz)	S11 REAL	S11 IMAGINARY
2150	17.6	-30.2
2155	17.6	-30.0
2160	17.7	-29.8
2165	17.7	-29.6
2170	17.8	-29.5
2175	17.9	-29.3
2180	17.9	-29.1
2185	18.0	-28.9
2190	18.1	-28.7
2195	18.1	-28.5
2200	18.2	-28.3
2205	18.3	-28.2
2210	18.4	-28.0
2070	16.9	-33.3
2075	16.9	-33.1

Table 7. Typical LNAOUTH (High Gain) S11 Parameters ($V_{CC_} = +3.3V$, $T_A = +25^{\circ}C$)

FREQUENCY (MHz)	S11 REAL	S11 IMAGINARY
1880	28.2	-5.7
1885	28.5	-5.2
1890	28.8	-4.7
1895	29.1	-4.3
1900	29.4	-3.8
1905	29.7	-3.3
1910	30.0	-2.8
1915	30.3	-2.4
1920	30.6	-1.9
1925	31.0	-1.4
1930	31.3	-0.9
1935	31.6	-0.4
1940	31.9	0.0
1945	32.3	0.5
1950	32.6	1.0

FREQUENCY (MHz)	S11 REAL	S11 IMAGINARY
1955	33.0	1.5
1960	33.3	2.0
1965	33.7	2.5
1970	34.1	2.9
1975	34.4	3.4
1980	34.8	3.9
1985	35.2	4.4
1990	35.6	4.9
1995	36.0	5.4
2000	36.4	5.8
2005	36.8	6.3
2010	37.2	6.8
2015	37.6	7.3
2020	38.0	7.8

MAX2550

Band I, V, and VIII WCDMA Femtocell Transceiver with GSM Monitoring

Digital I/Q Receive Interface

The baseband output of the device is in the form of a digital I/Q interface. The received signals are sampled by a 1-bit sigma-delta modulator clocked at 153.6MHz for WCDMA and 26MHz for GSMK. The digital bitstream out of the converter is transported from the device to the baseband processor by a low-voltage differential signaling (LVDS) interface. The output data is single-bit nonreturn-to-zero (NRZ). The device does not perform any encoding of the data and no clock is exchanged between the device and the baseband processor.

The device performs limited analog filtering only to minimize aliasing; all channel filtering is realized entirely in the digital domain. The digital filtering removes undesired signals as well as the inherent quantization noise of the sigma-delta modulator. In addition, the device's analog filters include a pole at approximately half the channel bandwidth that must be equalized by the digital filters.

The differential outputs require a termination resistor at the digital baseband IC inputs. The output current of the LVDS drivers are programmable by the LVDSI_2X bit in the BB_CLKOUT register to accommodate different termination resistors. Set LVDSI_2X = 1 to set the drive current to nominal for operation with 120Ω differential loads.

Digital I/Q Transmit Interface

The Tx baseband input of the device is in the form of a sigma-delta modulated digital I/Q interface. The digital bitstream of the baseband processor is transported to the device by a low-voltage differential signaling (LVDS) or DDR3 interface. The LVDS signal has a typical common-mode voltage of 1.2V and a differential swing of 140mV_{p-p}, while DDR3 has a common-mode voltage of 0.75V and differential of 600mV_{p-p}. For LVDS, the input data should be in single-bit NRZ format; no clock is exchanged between the baseband processor and the device. The device recovers the I/Q bitstreams with an on-chip data recovery circuit. The bitstream is converted to an analog signal and filtered prior to upconversion to an RF signal.

Baseband Input Level

The baseband input is in digital 1-bit sigma-delta converted format. There are internal 1-bit I/Q DACs that restore the level of the incoming digital signals to a repeatable analog level in the device. At a given TX_GAIN value, the RMS output power level depends on the density of the bit stream, not the voltage level of the LVDS digital signal. The density of the bit stream, in turn, depends on the input level of the sigma-delta converter, which resides in the baseband chip. The condition for the AC performance in the EC table calls for -4dBFS peak, which means -4dB relative to the full scale of the input of the sigma-delta converter. The sigma-delta converter, coded in Verilog, and implemented on FPGA has 10 bits (9 bits + sign) at the input. In this case, the full scale is ±511, and -4dBFS peak means ±322 peak excursion. The RMS level is lower than this number, depending on the peak-average ratio of the signal. For TM1, the peak-average is 10.6dB at 0.01%, so the RMS level of the baseband signal is -14.6dBFS, or ±95.

DC Offset

While the inherent DC offset at the I/Q outputs is very low, it is expected that the baseband processor digitally removes any DC offset.

Digital Filters/Sigma Delta Modulator

Verilog code is available for implementation of the sigma-delta modulator and digital filters in the baseband processor. Contact the factory for more information.

Fractional-N Synthesizers

The device includes three fractional-N frequency synthesizers. One synthesizer is used to generate the receive RF local oscillator (LO), the second is used to generate the transmit RF local oscillator, while the third is used to generate the ADC sampling clock. The loop filter for the ADC sampling clock synthesizer is integrated on-chip. RF synthesizers require an external loop filter. All synthesizers have 20 bits of fractional resolution.

MAX2550

Band I, V, and VIII WCDMA Femtocell Transceiver with GSM Monitoring

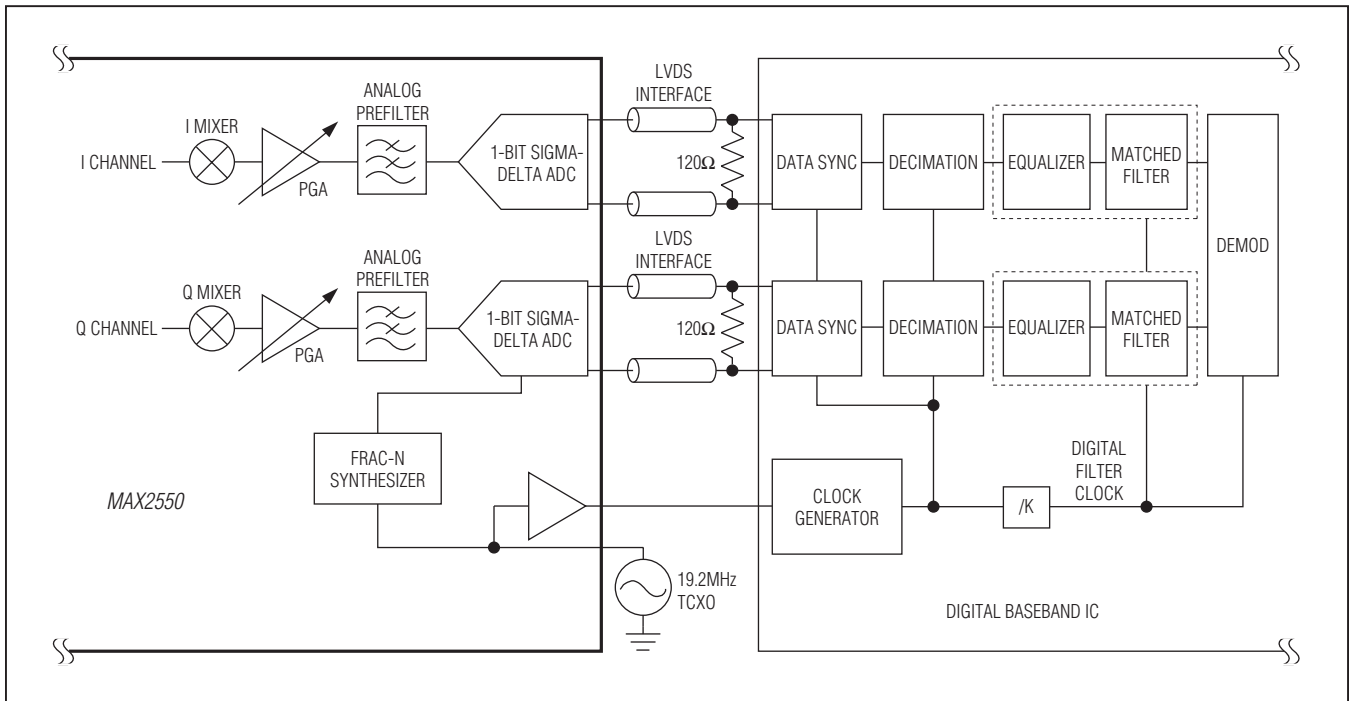

Figure 1. Digital Baseband Receiver Interface

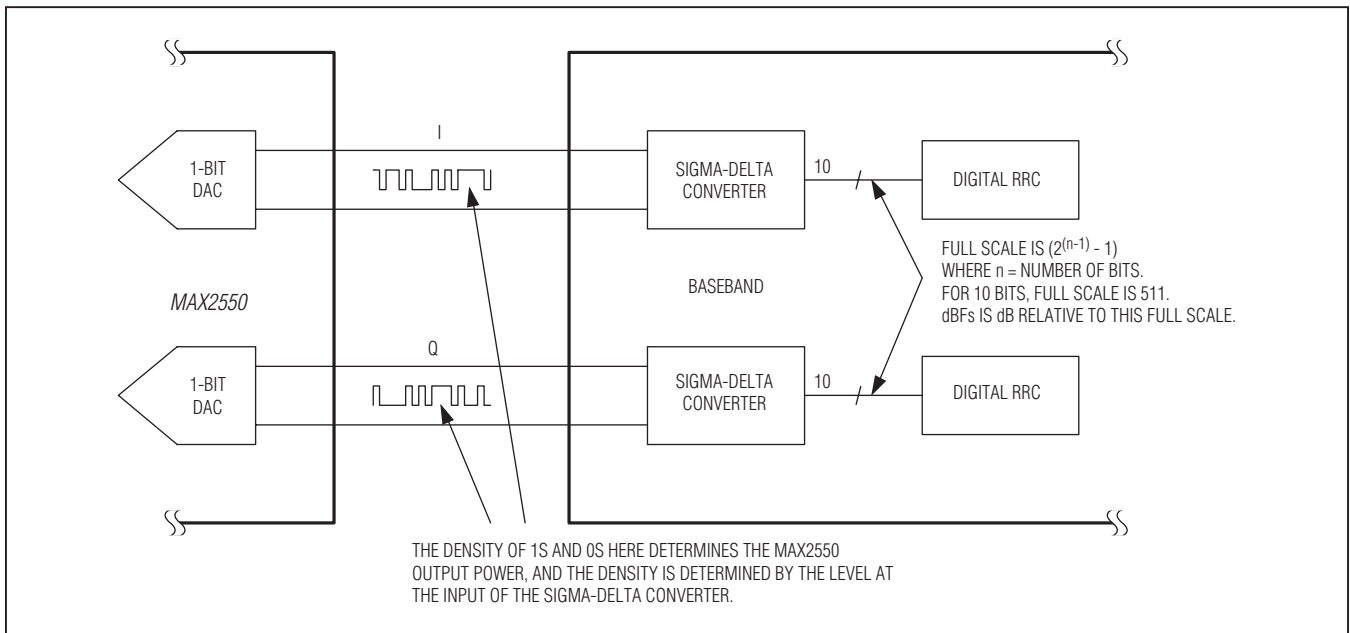

Figure 2. Baseband Input Example

MAX2550

Band I, V, and VIII WCDMA Femtocell Transceiver with GSM Monitoring

RF Synthesizers

For the receiver the RF LO frequency is programmed by the RXLO_FRAC [19:0] (Fractional) register and the RXLO_SYN[7:0] (Integer) register. The synthesizer frequency is demonstrated by the following example.

Assume:

$$f_{\text{REFIN}} = f_{\text{COMPARISON}} = 19.2\text{MHz}$$

$$f_{\text{LO}} = f_{\text{REFIN}} \times \left(\text{RXLO_SYN} + \frac{\text{RXLO_FRAC}}{2^{20}} \right) \times K$$

where:

K = 1 if RXIN1, RXIN2, RXIN5

K = 0.5 if RXIN3, RXIN4

For the transmitter the RF LO frequency is programmed by the TXLO_FRAC [19:0] (Fractional) register and the TXLO_SYN[7:0] (Integer) register. The synthesizer frequency is demonstrated by the following example.

Assume:

$$f_{\text{REFIN}} = f_{\text{COMPARISON}} = 19.2\text{MHz}$$

$$f_{\text{LO}} = f_{\text{REFIN}} \times \left(\text{TXLO_SYN} + \frac{\text{TXLO_FRAC}}{2^{20}} \right) \times K$$

where:

K = 0.5 for TXOUTL

K = 1 for TXOUTH

Calculate the required divider ratio by dividing the LO frequency by the reference frequency.

$$\text{Divider} = \frac{f_{\text{LO}} \times 2}{f_{\text{COMPARISON}}} = \frac{1910\text{MHz}}{19.2\text{MHz}} = 99.479166$$

The integer-N divider is equal to the integer portion of the divider ratio, 99 in this example. Convert the integer-N decimal value to binary and program into the RXLO_SYN bits.

$$\text{Integer-N divider} = 99 = 0x63 = 0110\ 0011 \rightarrow \\ \text{RXLO_SYN} = 0110\ 0011$$

The fractional-N divider is equal to the fractional portion of the divider ration, 0.479166 in this example. Convert the fractional portion of the divider to a 20-bit word by

multiplying by 2^{20} and rounding to the nearest whole number. Then, convert the result to binary and program the bits into the RXLO_FRAC.

$$\text{Fractional-N divider} = 0.479166 \times 2^{20} = 502442 = \\ 0x7A55A \rightarrow \text{RXLO_FRAC} = 0x7A55A$$

ADC Clock Synthesizer

The sampling clock frequency is controlled by the CINT (BBCLK_SYN[7:0]) and CFRAC (BBCLK_FRAC[19:0]) registers. The sampling clock synthesizer does not need to be repeatedly programmed during normal operation. The sampling clock frequency (f_{ADCCLK}) is 153.6MHz in WCDMA mode and 26MHz in GSM mode. The dynamic range of the converters with this sampling frequency is sufficient to meet all system specifications with very minimal control of the PGA.

Assume:

$$f_{\text{REFIN}} = f_{\text{COMPARISON}} = 19.2\text{MHz}$$

ADC Clock Synthesizer Fractional Frequency Correction

The ADC clock synthesizer uses a 20-bit frequency synthesizer and can be enhanced by a fractional error correction. Parameters PBYQ_RATUP and PBYQ_RATDN implement the following function.

$$f_{\text{ADCCLK}} = f_{\text{REFIN}} \times \left(\text{CINT} + \frac{\text{CFRAC} + \text{PBYQ_RATUP}}{\text{PBYQ_RATUP} + \text{PBYQ_RATDN}} \right) / 2^{20} \times K \\ \text{PBYQ_RATUP} / (\text{PBYQ_RATUP} + \text{PBYQ_RATDN}) = \\ (f_{\text{ADCCLK}} / f_{\text{REFIN}} - \text{CINT}) \times 2^{20} \times K - \text{CFRAC}$$

where:

K = 8 if WCDMA

K = 48 if GSM/PCS/DCS

PBYQ_RATUP and PBYQ_RATDN should be chosen for the best fit.

This feature can be enabled or disabled through EN_PBYQDIV (REG15<22>). Table 8 shows the PBYQ_RATUP and PBYQ_RATDN with commonly used crystal oscillator frequencies.

Power-Down Modes

The device features multiple power-down modes that can be controlled by hardware or software. Table 9 describes the various power-down modes.

MAX2550

Band I, V, and VIII WCDMA Femtocell Transceiver with GSM Monitoring

Table 8. Typical LNAOUTL (High Gain) S11 Parameters ($V_{CC_} = +3.3V$, $T_A = +25^\circ C$)

FREQUENCY (MHz)	S11 REAL	S11 IMAGINARY
795	40.1	-4.0
800	40.8	-3.3
805	41.6	-2.6
810	42.3	-1.9
815	43.1	-1.2
820	43.9	-0.6
825	44.7	0.1
830	45.5	0.7
835	46.4	1.3
840	47.2	1.9
845	48.1	2.5
850	49.0	3.1
855	49.9	3.7
860	50.8	4.2
865	51.7	4.8

FREQUENCY (MHz)	S11 REAL	S11 IMAGINARY
870	52.7	5.3
875	53.6	5.8
880	54.6	6.3
885	55.6	6.7
890	56.6	7.2
895	57.6	7.6
900	58.6	8.0
905	59.7	8.4
910	60.7	8.8
915	61.8	9.1
920	62.9	9.4
925	64.0	9.7
930	65.1	10.0
935	66.3	10.2

Table 9. Typical MIXINH S11 Parameters ($V_{CC_} = +3.3V$, $T_A = +25^\circ C$)

FREQUENCY (MHz)	S11 REAL	S11 IMAGINARY
1880	28.55	-31.48
1885	28.77	-31.50
1890	28.98	-31.53
1895	29.19	-31.56
1900	29.39	-31.60
1905	29.59	-31.64
1910	29.79	-31.69
1915	29.98	-31.75
1920	30.16	-31.81
1925	30.34	-31.87
1930	30.52	-31.94
1935	30.69	-32.01
1940	30.85	-32.09
1945	31.01	-32.17
1950	31.16	-32.26

FREQUENCY (MHz)	REAL	IMAGINARY
1955	31.31	-32.35
1960	31.45	-32.44
1965	31.59	-32.54
1970	31.72	-32.64
1975	31.84	-32.74
1980	31.96	-32.85
1985	32.07	-32.95
1990	32.18	-33.06
1995	32.28	-33.18
2000	32.37	-33.29
2005	32.46	-33.41
2010	32.54	-33.52
2015	32.61	-33.64
2020	32.68	-33.76

MAX2550

Band I, V, and VIII WCDMA Femtocell Transceiver with GSM Monitoring

Carrier and Sideband Suppression Optimization

The device delivers a typical carrier suppression of -40dBc and a sideband suppression of -45dBc without any external calibration; however, if greater suppression is required, the device is capable of overriding the factory settings and accepting manual calibration from the baseband processor.

RF Band Configuration

The device has configurable VCO and LO generation to support Bands I, V, and VIII forward and reverse link operation. In transmit signal path, LC tank is also configurable to optimize performance in both bands. Table 10 shows the key difference in SPI settings.

General-Purpose Outputs

The device is equipped with three general-purpose outputs. GPO3 can also be configured as a PLL lock detect for the Rx, Tx, or Rx and Tx. See Table 20 for how to properly configure the general-purpose outputs.

Table 10. Typical MIXINL S11 Parameters ($V_{CC_} = +3.3V$, $T_A = +25^{\circ}C$)

FREQUENCY (MHz)	S11 REAL	S11 IMAGINARY
795	25.70	-43.40
800	26.10	-42.50
805	26.50	-41.60
810	27.00	-40.70
815	27.50	-39.80
820	28.00	-38.90
825	28.60	-38.00
830	29.20	-37.10
835	29.90	-36.30
840	30.60	-35.50
845	31.40	-34.70
850	32.20	-33.90
855	33.10	-33.10
860	33.97	-32.34
865	35.01	-31.60

FREQUENCY (MHz)	REAL	IMAGINARY
870	36.10	-30.90
875	37.22	-30.22
880	38.39	-29.58
885	39.60	-28.97
890	40.85	-28.41
895	42.14	-27.89
900	43.48	-27.42
905	44.85	-27.00
910	46.27	-26.64
915	47.73	-26.35
920	49.22	-26.11
925	50.75	-25.95
930	52.31	-25.87
935	53.91	-25.86

MAX2550

Band I, V, and VIII WCDMA Femtocell Transceiver with GSM Monitoring

Power-On Reset (POR)

Recommended defaults are not guaranteed upon power-up and are provided for reference only. All registers must be written with the proper values no earlier than 100µs after power-up. Figure 3 displays the time it takes for Tx/Rx PLL lock detect (GPO3) to become active after power-up and enabling the correct registers for proper operation. All reserved registers should only be written with default values.

Temperature Sensor

An on-chip temperature sensor is enabled by programming `RX_ENABLE<14> = 1`. To trigger temperature sensor ADC reading, program `RX_MISC2<6>` from 0 to 1. The ADC acquires the 5-bit logic output in 2µs; the temperature sensor needs to be on (`RX_ENABLE<14> = 1`) to maintain the ADC logic output. To read the 5-bit logic output through the DOUT pin, apply 4-wire SPI readout programming sequence to `RX_MISC2<11:7>`.

4-Wire Serial Interface

The device includes 32 programmable 26-bit registers. The most significant bit (MSB) is the read/write selection bit (R/W in Figure 4). The next 5 bits are register address (A[4:0] in Figure 4). The 26 least significant bits (LSBs) are register data (D[25:0] in Figure 4). Register data is loaded through the 4-wire SPI/MICROWIRE™-compatible serial interface. MSB of data at the DIN pin is shifted in first and is framed by \overline{CS} . When \overline{CS} is low, input data is shifted at the rising edge of the clock at the SCLK pin. At \overline{CS} rising edge, the 26-bit data bits are latched into the register selected by the address bits. See Figure 4. There is no power-on SPI register self-reset functionality in the device; the user must program all register values after power-up. During the read mode, register data selected by address bits is shifted out to the DOUT pin at the falling edges of the clock.

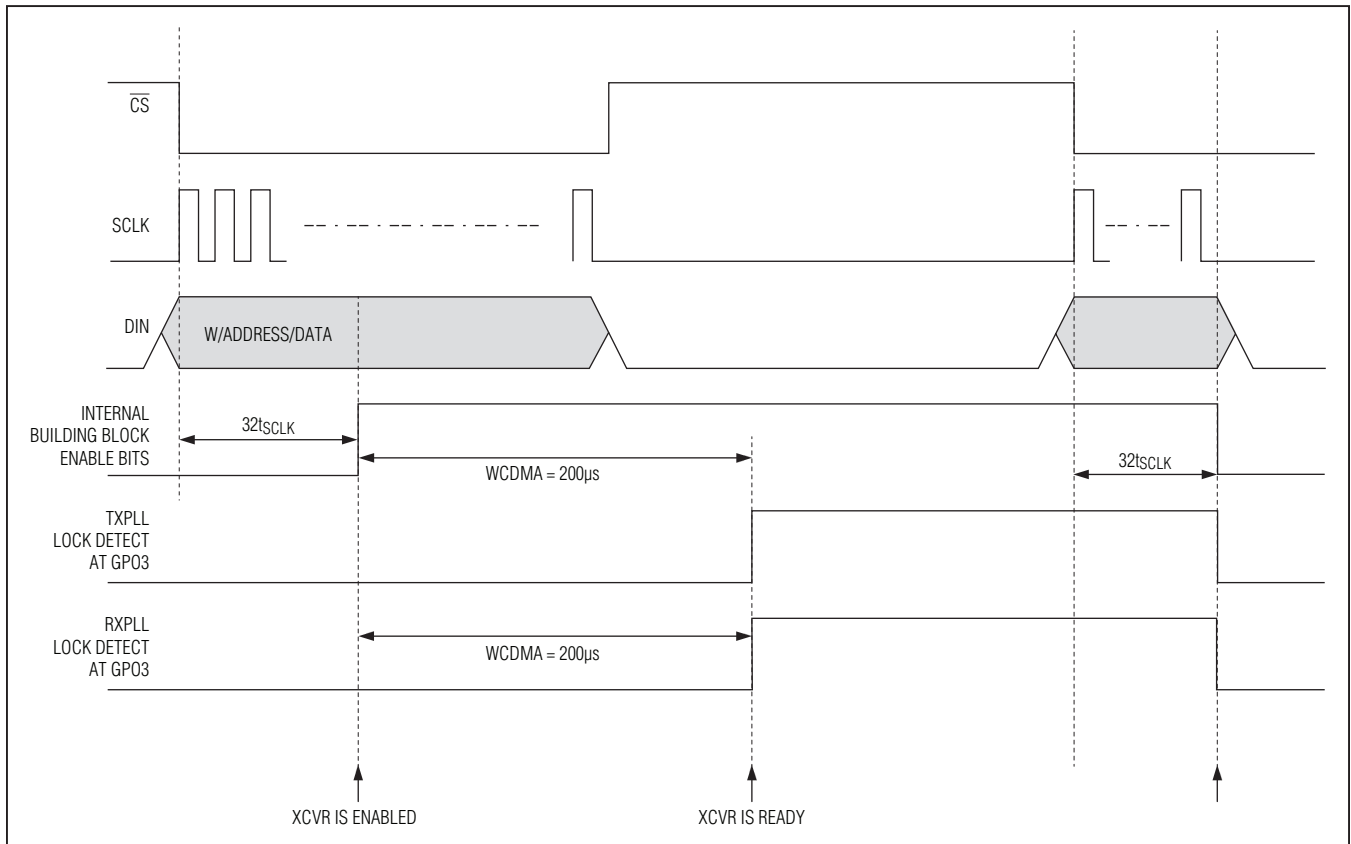

Figure 3. POR PLL Lock-Detect Time

MICROWIRE is a trademark of National Semiconductor Corp.

MAX2550

Band I, V, and VIII WCDMA Femtocell Transceiver with GSM Monitoring

Table 11. Typical TXOUTL S11 Parameters ($V_{CC_} = +3.3V$, $T_A = +25^\circ C$)

FREQUENCY (MHz)	REAL	IMAGINARY
700.0	25.5	63.9
750.0	52.3	76.8
800.0	103.7	59.2
850.0	107.4	-9.9
900.0	64.8	-32.6
950.0	39.6	-27.2
1000.0	27.2	-18.9
1050.0	20.7	-11.8
1100.0	16.9	-6.1
1150.0	14.5	-1.3
1200.0	12.9	2.7
1250.0	11.8	6.3
1300.0	11.1	9.4
1350.0	10.5	12.3
1400.0	10.1	15.0
1450.0	9.9	17.6

FREQUENCY (MHz)	REAL	IMAGINARY
1500.0	9.7	20.1
1550.0	9.6	22.5
1600.0	9.6	24.8
1650.0	9.6	27.1
1700.0	9.7	29.4
1750.0	9.8	31.6
1800.0	10.0	33.9
1850.0	10.2	36.2
1900.0	10.4	38.6
1950.0	10.7	41.0
2000.0	11.0	43.5
2050.0	11.3	46.0
2100.0	11.7	48.6
2150.0	12.2	51.4
2200.0	12.7	54.2

Table 12. Typical TXOUTH S11 Parameters ($V_{CC_} = +3.3V$, $T_A = +25^\circ C$)

FREQUENCY (MHz)	REAL	IMAGINARY
700.0	3.7	21.9
750.0	3.9	23.9
800.0	4.2	26.0
850.0	4.5	28.2
900.0	4.8	30.5
950.0	5.2	33.1
1000.0	5.8	35.8
1050.0	6.4	38.9
1100.0	7.2	42.2
1150.0	8.3	45.8
1200.0	9.7	50.0
1250.0	11.5	54.6
1300.0	14.0	60.0
1350.0	17.5	66.1
1400.0	22.5	73.2
1450.0	29.9	81.2

FREQUENCY (MHz)	REAL	IMAGINARY
1500.0	41.1	89.9
1550.0	58.2	98.0
1600.0	83.9	101.3
1650.0	117.3	91.2
1700.0	146.2	58.0
1750.0	149.1	10.8
1800.0	126.3	-24.1
1850.0	97.4	-38.3
1900.0	74.0	-39.5
1950.0	57.4	-35.4
2000.0	45.8	-29.5
2050.0	37.8	-23.5
2100.0	32.0	-17.8
2150.0	27.8	-12.6
2200.0	24.7	-7.8

MAX2550

Band I, V, and VIII WCDMA Femtocell Transceiver with GSM Monitoring

Table 13. PBYQ_RATUP and PBYQ_RATDN Commonly Used Crystal Oscillator Frequencies

	f _{REFIN} (MHz)	CINT REG15 <7:0>	CFRAC REG1 <19:0>	PBYQ_RATUP REG16 <7:0>	PBYQ_RATDN REG16 <15:8>	CINT REG15 <7:0>	CFRAC REG14 <19:0>	PBYQ_RATUP REG16<7:0>	PBYQ_RATDN REG16<15:8>
STANDARD	Reference Frequency	Integer Divide Ratio (dec)	Fractional Divide Ratio (dec)	Fractional LSB Dither Up (dec)	Fractional LSB Dither Down (dec)	Integer Divide Ratio (hex)	Fractional Divide Ratio (hex)	Fractional LSB Dither Up (hex)	Fractional LSB Dither Down (hex)
WCDMA	13	94	548485	59	6	5E	85E85	3B	6
	15.36	80	0	0	0	50	0	0	0
	19.2	64	0	0	0	40	0	0	0
	20	61	461373	11	14	3D	70A3D	B	E
	26	47	274242	62	3	2F	42F42	3E	3
GSM	13	96	0	0	0	60	0	0	0
	15.36	81	262144	0	0	51	40000	0	0
	19.2	65	0	0	0	41	0	0	0
	20	62	419430	2	3	3E	66666	2	3
	26	48	0	0	0	30	0	0	0

Table 14. Power-Down Modes

OPERATING MODE	REFEN PIN, REG29<14:12>	BLOCKS ENABLE REG00<18:0>	BIAS ENABLE REG20<24>	AFCDAC ENABLE REG30<19>	CDR DIVIDER ENABLE REG16<20>	CDR ENABLE REG24<18>
Sleep	0000	00000	0	0	0	0
AFC Only	0000	00000	0	1	0	0
Reference Buffer Only	1xxx or 0100	00000	0	1	0	0
Idle RX	1xxx or 0x11	00840	1	1	0	0
Idle TX	1xxx or 0x11	01000	1	1	1	1
RXIN1/TXOUTH Full Duplex	1xxx or 0x11	79BFF	1	1	1	1
RXIN1 Only	1xxx or 0x11	009FF	1	1	0	0
RXIN3/TXOUTL Full Duplex	1xxx or 0x11	79BFF	1	1	1	1
RXIN3 Only	1xxx or 0x11	009FF	1	1	0	0
RXIN4 Monitor	1xxx or 0x11	009FF	1	1	0	0
RXIN5 Monitor	1xxx or 0x11	009FF	1	1	0	0
TXOUTL Only	1xxx or 0x11	79240	1	1	1	1
TXOUTH Only	1xxx or 0x11	79240	1	1	1	1
RXIN2	1xx or 0x11	009FF	1	1	0	0

MAX2550

Band I, V, and VIII WCDMA Femtocell Transceiver with GSM Monitoring

Table 15. RF Band Configuration

INPUT PIN	RF RANGE (MHz)	VCO SELECT REG03<20:19>	VCO ROH BAND REG03<22:21>	VCO DIVIDER REG03<18:17>	LNA/MIXER SELECT REG01<5:0>	RXIN4_HB REG06<16>
RXIN1	1920 to 1980	10	01	10	18	X
RXIN3 (Band V)	820 to 849	01	XX	01	01	X
RXIN3 (Band VIII)	880 to 915	10	11	01	01	X
RXIN4 (Band V)	865 to 894	01	00	01	15	0
RXIN4 (Band VIII)	925 to 960	10	01	01	15	1
RXIN5	2110 to 2170	10	00	10	2A	X
RXIN2	1805 to 1880	10	11	10	0C	X

OUTPUT PIN	RF RANGE (MHz)	VCO SELECT REG28 <15:14>	VCO ROH BAND REG28 <17:16>	VCO DIVIDER REG28 <13:12>	PAD_BAND REG19 <1:0>	PAD_CTUNE REG19 <6:2>	TXLO_IQ_GAIN REG20 <19>	UCX_CSW REG21 <5:2>	T_UCX_RSW REG22 <20:17>	T_UCX_BAND_SEL REG22 <23:22>
TX_OUTL (Band VIII)	925 to 960	10	01	01	00	00100	1	1011	XXXX	01
TX_OUTL (Band V)	865 to 894	01	00	01	00	00100	1	1101	XXXX	01
TX_OUTH	2110 to 2170	11	00	10	11	00000	0	0000	0101	11

MAX2550

Band I, V, and VIII WCDMA Femtocell Transceiver with GSM Monitoring

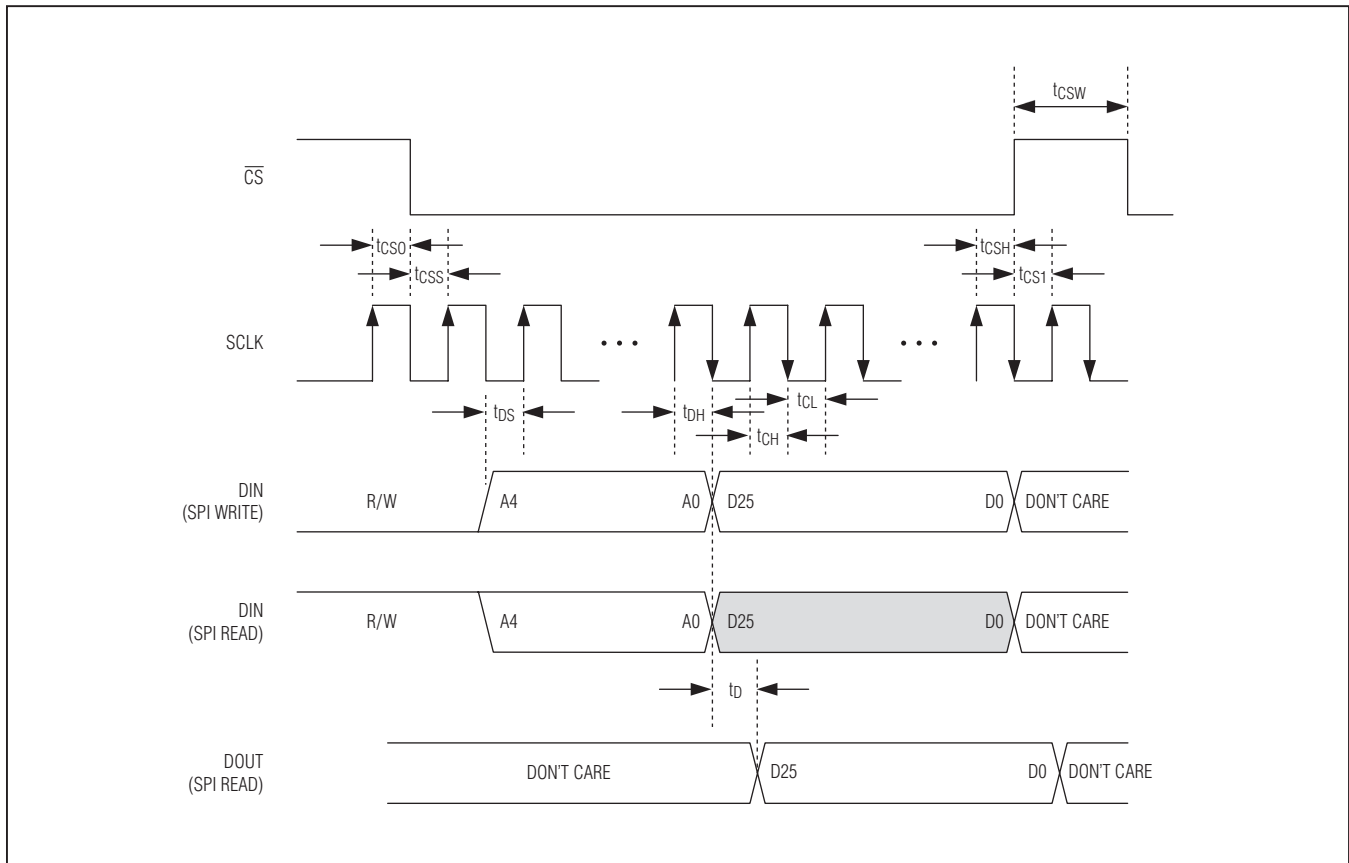

Figure 4. SPI Timing

Table 16. SPI Serial Interface Timing

SPEC NO.	PARAMETER	SYMBOL	TYP	UNITS
SPI1	SCLK Rising Edge to \overline{CS} Falling Edge Wait Time	t_{CS0}	6	ns
SPI2	Falling Edge of \overline{CS} to Rising Edge of First SCLK Time	t_{CSS}	6	ns
SPI3	DIN to SCLK Setup Time	t_{DS}	6	ns
SPI4	DIN to SCLK Hold Time	t_{DH}	6	ns
SPI5	SCLK Pulse-Width High	t_{CH}	6	ns
SPI6	SCLK Pulse-Width Low	t_{CL}	6	ns
SPI7	Last Rising Edge of SCLK to Rising Edge of \overline{CS}	t_{CSH}	6	ns
SPI8	\overline{CS} High Pulse Width	t_{CSW}	50	ns
SPI9	Time Between Rising Edge of \overline{CS} and the Next Rising Edge of SCLK	t_{CS1}	6	ns
SPI10	SCLK Frequency	f_{CLK}	40	MHz
SPI11	Rise Time	t_R	2.5	ns
SPI12	Fall Time	t_F	2.5	ns
SPI13	SCLK Falling Edge to Valid DOUT	t_D	12.5	ns

MAX2550

Band I, V, and VIII WCDMA Femtocell Transceiver with GSM Monitoring

Register and Bit Descriptions (If Applicable)

The operating mode of the device is completely controlled by 32 on-chip registers.

Recommended defaults are not guaranteed upon power-up and are provided for reference only. All registers must be written with the proper values no earlier than 10 μ s after power-up (once $V_{CC_}$ is 90% of final value). All reserved registers should only be written with default values.

Table 17. Brief Register Map

REGISTER NO.	REGISTER NAME	ADDRESS	FUNCTION
0	RX_ENABLE	00000	Enable bits for various internal functions
1	RX_GAIN	00001	Gain control of LNA and PGA
2	Reserved	00010	—
3	RX_LNA	00011	LNA bias, Rx synthesizer configuration
4	Reserved	00100	—
5	Reserved	00101	—
6	RX_LPF	00110	RXLPF configuration
7	GPO_CONFIG	00111	Configuration of GPOs
8	Reserved	01000	—
9	Reserved	01001	—
10	RXLO_FRAC	01010	Receive synthesizer fractional division ratio
11	RXLO_SYN	01011	Configuration of Rx synthesizer
12	BBCLK_OUT	01100	ADC configuration
13	Reserved	01101	—
14	BBCLK_FRAC	01110	ADC clock generator fractional division ratio
15	BBCLK_SYN	01111	Configuration of clock generator synthesizer
16	BBCLK_MISC	10000	Dithering clock generator synthesizer
17	BBCLK_SPARE	10001	Miscellaneous setting for clock generator
18	TX_LPF	10010	LPF settings for Tx path
19	TX_PAD	10011	PA driver settings
20	TX_UPX1	10100	Tx upconverter bias
21	TX_UPX2	10101	Tx upconverter bias adjustment and V2I attenuation
22	TX_UPX3	10110	Tx upconverter DC offset adjustment
23	TX_GAIN1	10111	Tx path gain setting
24	TX_GAIN2	11000	Tx path gain curve adjustment
25	Reserved	11001	—
26	Reserved	11010	—
27	TXLO_FRAC	11011	Transmit synthesizer fractional division ratio
28	TXLO_SYN	11100	Configuration of Tx synthesizer
29	TXLO_REF	11101	Configuring REFOUT and REFIN
30	TXLO_AFCDAC	11110	AFC DAC word
31	Reserved	11111	—

MAX2550

Band I, V, and VIII WCDMA Femtocell Transceiver with GSM Monitoring

Table 18. RX_ENABLE Register 0 (Address = 00000)

BIT	BIT ID	NAME	DEFINITION	BIT	BAND1 RX1 ONLY	DCS RX2 ONLY	BAND V RX3 ONLY	BAND VIII RX3 ONLY	BAND V RX4 ONLY	BAND VIII RX4 ONLY	BAND I RX5 ONLY	BAND I TXH ONLY	BAND V TXL ONLY	BAND VIII TXL ONLY	BAND I RX1/TXH FDD	BAND V RX3/TXL FDD	BAND VIII RX3/TXL FDD	BAND I RX IDLE	BAND I TX IDLE	AFC ONLY	REFERENCE BUFFER	SLEEP
0	LNAEN	LNA Enable	0 = Disable 1 = Enable	0	1	1	1	1	1	1	1	0	0	0	1	1	1	0	0	0	0	0
1	RXMXREN	Rx Mixer Enable	0 = Disable 1 = Enable	0	1	1	1	1	1	1	1	0	0	0	1	1	1	0	0	0	0	0
2	RXLPFEN	Rx LPF Enable	0 = Disable 1 = Enable	0	1	1	1	1	1	1	1	0	0	0	1	1	1	0	0	0	0	0
3	PGAQEN	Rx Q PGA Enable	0 = Disable 1 = Enable	0	1	1	1	1	1	1	1	0	0	0	1	1	1	0	0	0	0	0
4	PGA IEN	Rx I PGA Enable	0 = Disable 1 = Enable	0	1	1	1	1	1	1	1	0	0	0	1	1	1	0	0	0	0	0
5	ADCEN	ADC Enable	0 = Disable 1 = Enable	0	1	1	1	1	1	1	1	0	0	0	1	1	1	0	0	0	0	0
6	ADCCLKEN	ADC Clock Enable	0 = Disable 1 = Enable	0	1	1	1	1	1	1	1	1	1	1	1	1	1	1	1	0	0	0
7	LVDSQ	Rx Q LVDS Enable	0 = Disable 1 = Enable	0	1	1	1	1	1	1	1	0	0	0	1	1	1	0	0	0	0	0
8	LVDSI	Rx I LVDS Enable	0 = Disable 1 = Enable	0	1	1	1	1	1	1	1	0	0	0	1	1	1	0	0	0	0	0
9	TXVGCEN	Tx VGC Enable	0 = Disable 1 = Enable	0	0	0	0	0	0	0	0	1	1	1	1	1	1	0	0	0	0	0

MAX2550

Band I, V, and VIII WCDMA Femtocell Transceiver with GSM Monitoring

Table 18. RX_ENABLE Register 0 (Address = 00000) (continued)

BIT	BIT ID	NAME	DEFINITION	BIT	BAND1 RX1 ONLY	DCS RX2 ONLY	BAND V RX3 ONLY	BAND8 RX3 ONLY	BAND5 RX4 ONLY	BAND8 RX4 ONLY	BAND1 RX5 ONLY	BAND1 TXH ONLY	BAND5 TXL ONLY	BAND8 TXL ONLY	BAND1 RX1/TXH FDD	BAND5 RX3/TXL FDD	BAND8 RX3/TXL FDD	BAND1 RX IDLE	BAND1 TX IDLE	AFC ONLY	REFERENCE BUFFER	SLEEP	
10	Reserved	Reserved	—	0	0	0	0	0	0	0	0	0	0	0	0	0	0	0	0	0	0	0	
11	RXSYNEN	Rx SYN Enable	0 = Disable 1 = Enable	0	1	1	1	1	1	1	1	0	0	0	1	1	1	1	1	0	0	0	0
12	TXSYNEN	Tx SYN Enable	0 = Disable 1 = Enable	0	0	0	0	0	0	0	0	1	1	1	1	1	1	0	0	0	0	0	0
13	BBLBEN	BB Loopback Enable	0 = Disable 1 = Enable	0	0	0	0	0	0	0	0	0	0	0	0	0	0	0	0	0	0	0	0
14	TSEN	Temperature Sensor Enable	0 = Disable 1 = Enable	0	0	0	0	0	0	0	0	0	0	0	0	0	0	0	0	0	0	0	0
15	PADEN	PA Driver Enable	0 = Disable 1 = Enable	0	0	0	0	0	0	0	0	1	1	1	1	1	1	0	0	0	0	0	0
16	TXLPFEN	Tx LPF Enable	0 = Disable 1 = Enable	0	0	0	0	0	0	0	0	1	1	1	1	1	1	0	0	0	0	0	0
17	TXLOEN	Tx LO Enable	0 = Disable 1 = Enable	0	0	0	0	0	0	0	0	1	1	1	1	1	1	0	0	0	0	0	0
18	UPCXEN	Upconverter Enable	0 = Disable 1 = Enable	0	0	0	0	0	0	0	0	1	1	1	1	1	1	0	0	0	0	0	0

MAX2550

Band I, V, and VIII WCDMA Femtocell Transceiver with GSM Monitoring

Table 18. RX_ENABLE Register 0 (Address = 00000) (continued)

BIT	BIT ID	NAME	DEFINITION	BIT	BAND1 RX1 ONLY	DCS RX2 ONLY	BAND V RX3 ONLY	BAND8 RX3 ONLY	BAND5 RX4 ONLY	BAND8 RX4 ONLY	BAND1 RX5 ONLY	BAND1 TXH ONLY	BAND5 TXL ONLY	BAND8 TXL ONLY	BAND1 RX1/TXH FDD	BAND5 RX3/TXL FDD	BAND8 RX3/TXL FDD	BAND1 RX IDLE	BAND1 TX IDLE	AFC ONLY	REFERENCE BUFFER	SLEEP			
19	Reserved	Reserved		0	0	0	0	0	0	0	0	0	0	0	0	0	0	0	0	0	0	0			
20				1	0	0	0	0	0	0	0	0	0	0	0	0	0	0	0	0	0	0	0	0	
21				2	0	0	0	0	0	0	0	0	0	0	0	0	0	0	0	0	0	0	0	0	
22				3	0	0	0	0	0	0	0	0	0	0	0	0	0	0	0	0	0	0	0	0	
23				4	0	0	0	0	0	0	0	0	0	0	0	0	0	0	0	0	0	0	0	0	0
24				5	0	0	0	0	0	0	0	0	0	0	0	0	0	0	0	0	0	0	0	0	0
25				6	0	0	0	0	0	0	0	0	0	0	0	0	0	0	0	0	0	0	0	0	0

MAX2550

Band I, V, and VIII WCDMA Femtocell Transceiver with GSM Monitoring

Table 19. RX_GAIN Register 1 (Address = 00001)

BIT	BIT ID	NAME	DEFINITION	BIT	BAND1 RX1 ONLY	DCS RX2 ONLY	BAND V RX3 ONLY	BAND8 RX3 ONLY	BAND5 RX4 ONLY	BAND8 RX4 ONLY	BAND1 RX5 ONLY	BAND1 TXH ONLY	BAND5 TXL ONLY	BAND8 TXL ONLY	BAND1 RX1/TXH FDD	BAND5 RX3/TXL FDD	BAND8 RX3/TXL FDD	BAND1 RX IDLE	BAND1 TX IDLE	AFC ONLY	REFERENCE BUFFER	SLEEP	
					0	1	2	0	1	0	1	0	1	0	1	0	1	0	1	0	1	0	1
0	LNASEL <2:0>	LNA Selection	<2:0> = 000 = RXIN1	0	0	0	1	1	1	1	0	0	1	1	0	1	1	0	0	0	0	0	
1			<2:0> = 100 = RXIN2	1	0	0	0	0	0	0	1	0	0	0	0	0	0	0	0	0	0	0	0
2			<2:0> = 001 = RXIN3 <2:0> = 101 = RXIN4 <2:0> = X10 = RXIN5	2	0	1	0	0	1	1	0	0	0	0	0	0	0	0	0	0	0	0	0
3	BandSel_Mix	Rx Mixer Select	0 = CEL mixer (default) 1 = PCS mixer	0	1	1	0	0	0	0	1	1	0	0	1	0	0	1	1	1	1	1	
4	MX_SW <1:0>	Rx Mixer Input Select	If BandSel_Mix = 1 (PCS) 00 = DCS input 01 = PCS input 10 = IMT input 11 = None	0	1	0	0	0	1	1	0	1	0	0	1	0	0	1	1	1	1	1	
5			If BandSel_Mix = 0 (CELL) 11 = None X0 = CELL input X1 = GSM input	1	0	0	0	0	0	0	0	1	0	0	0	0	0	0	0	0	0	0	0
6	Reserved	Reserved	—	0	0	0	0	0	0	0	0	0	0	0	0	0	0	0	0	0	0	0	
7				1	0	0	0	0	0	0	0	0	0	0	0	0	0	0	0	0	0	0	0
8	PGAGAIN <3:0>	Rx PGA Gain Control	<3:0> = 0000 = Min gain (default)	0	0	0	0	0	1	1	1	0	0	0	0	0	0	0	0	0	0	0	
9			<3:0> = 0001 = Min gain + 3dB	1	1	0	1	1	1	1	1	0	0	0	1	1	1	1	1	0	0	0	0
10			<3:0> = 1110 = Max gain - 3dB	2	1	1	1	1	0	0	0	0	0	0	1	1	1	1	1	1	0	0	0
11			<3:0> = 1111 = Max gain	3	0	1	0	0	1	1	1	1	0	0	0	0	0	0	0	0	0	0	0

MAX2550

Band I, V, and VIII WCDMA Femtocell Transceiver with GSM Monitoring

Table 19. RX_GAIN Register 1 (Address = 00001) (continued)

BIT	BIT ID	NAME	DEFINITION	BIT	BAND1 RX1 ONLY	DCS RX2 ONLY	BAND V RX3 ONLY	BAND8 RX3 ONLY	BAND5 RX4 ONLY	BAND8 RX4 ONLY	BAND1 RX5 ONLY	BAND1 TXH ONLY	BAND5 TXL ONLY	BAND8 TXL ONLY	BAND1 RX1/TXH FDD	BAND5 RX3/TXL FDD	BAND8 RX3/TXL FDD	BAND1 RX IDLE	BAND1 TX IDLE	AFC ONLY	REFERENCE BUFFER	SLEEP				
12	Reserved	Reserved	—	0	0	0	0	0	0	0	0	0	0	0	0	0	0	0	0	0	0					
13	Reserved	Reserved		1	0	0	0	0	0	0	0	0	0	0	0	0	0	0	0	0	0	0				
14	LNAGAIN <1:0>	LNA GAIN Control	<1:0> = 00 = Low gain <1:0> = 01 = Mid gain (not available for RXIN4) <1:0> = 10 = High gain (default) <1:0> = 11 = Do not use	0	0	0	0	0	0	0	0	0	0	0	0	0	0	0	0	0	0	0				
15				1	1	1	1	1	1	1	1	1	1	1	1	1	1	1	1	1	1	1	1	1		
16	Reserved	Reserved		—	0	0	0	0	0	0	0	0	0	0	0	0	0	0	0	0	0	0	0			
17					1	0	0	0	0	0	0	0	0	0	0	0	0	0	0	0	0	0	0	0	0	
18					3	0	0	0	0	0	0	0	0	0	0	0	0	0	0	0	0	0	0	0	0	0
19					4	0	0	0	0	0	0	0	0	0	0	0	0	0	0	0	0	0	0	0	0	0
20					5	0	0	0	0	0	0	0	0	0	0	0	0	0	0	0	0	0	0	0	0	0
21					6	0	0	0	0	0	0	0	0	0	0	0	0	0	0	0	0	0	0	0	0	0
22					7	0	0	0	0	0	0	0	0	0	0	0	0	0	0	0	0	0	0	0	0	0
23					8	0	0	0	0	0	0	0	0	0	0	0	0	0	0	0	0	0	0	0	0	0
24			9		0	0	0	0	0	0	0	0	0	0	0	0	0	0	0	0	0	0	0	0	0	
25			10		0	0	0	0	0	0	0	0	0	0	0	0	0	0	0	0	0	0	0	0	0	

MAX2550

Band I, V, and VIII WCDMA Femtocell Transceiver with GSM Monitoring

Table 20. Reserved Register 2 (Address = 00010)

BIT	BIT ID	NAME	DEFINITION	BIT	BAND I RX1 ONLY	DCS RX2 ONLY	BAND V RX3 ONLY	BAND VIII RX3 ONLY	BAND V RX4 ONLY	BAND VIII RX4 ONLY	BAND I RX5 ONLY	BAND I TXH ONLY	BAND V TXL ONLY	BAND VIII TXL ONLY	BAND I RX1/TXH FDD	BAND V RX3/TXL FDD	BAND VIII RX3/TXL FDD	BAND I RX IDLE	BAND I TX IDLE	AFC ONLY	REFERENCE BUFFER	SLEEP			
0	Reserved	Reserved	-	0	0	0	0	0	0	0	0	0	0	0	0	0	0	0	0	0	0	0			
1				0	0	0	0	0	0	0	0	0	0	0	0	0	0	0	0	0	0	0	0	0	
2				0	0	0	0	0	0	0	0	0	0	0	0	0	0	0	0	0	0	0	0	0	
3				0	0	0	0	0	0	0	0	0	0	0	0	0	0	0	0	0	0	0	0	0	
4				0	0	0	0	0	0	0	0	0	0	0	0	0	0	0	0	0	0	0	0	0	
5				0	0	0	0	0	0	0	0	0	0	0	0	0	0	0	0	0	0	0	0	0	
6				0	0	0	0	0	0	0	0	0	0	0	0	0	0	0	0	0	0	0	0	0	
7				0	0	0	0	0	0	0	0	0	0	0	0	0	0	0	0	0	0	0	0	0	
8				0	0	0	0	0	0	0	0	0	0	0	0	0	0	0	0	0	0	0	0	0	
9				0	0	0	0	0	0	0	0	0	0	0	0	0	0	0	0	0	0	0	0	0	
10				0	0	0	0	0	0	0	0	0	0	0	0	0	0	0	0	0	0	0	0	0	
11				0	0	0	0	0	0	0	0	0	0	0	0	0	0	0	0	0	0	0	0	0	
12				0	0	0	0	0	0	0	0	0	0	0	0	0	0	0	0	0	0	0	0	0	
13				0	0	0	0	0	0	0	0	0	0	0	0	0	0	0	0	0	0	0	0	0	
14				0	0	0	0	0	0	0	0	0	0	0	0	0	0	0	0	0	0	0	0	0	
15				0	0	0	0	0	0	0	0	0	0	0	0	0	0	0	0	0	0	0	0	0	
16				0	0	0	0	0	0	0	0	0	0	0	0	0	0	0	0	0	0	0	0	0	
17				0	0	0	0	0	0	0	0	0	0	0	0	0	0	0	0	0	0	0	0	0	
18				0	0	0	0	0	0	0	0	0	0	0	0	0	0	0	0	0	0	0	0	0	
19				0	0	0	0	0	0	0	0	0	0	0	0	0	0	0	0	0	0	0	0	0	
20				0	0	0	0	0	0	0	0	0	0	0	0	0	0	0	0	0	0	0	0	0	
21				0	0	0	0	0	0	0	0	0	0	0	0	0	0	0	0	0	0	0	0	0	
22				0	0	0	0	0	0	0	0	0	0	0	0	0	0	0	0	0	0	0	0	0	
23				1	1	1	1	1	1	1	1	1	1	1	1	1	1	1	1	1	1	1	1	1	1
24				1	1	1	1	1	1	1	1	1	1	1	1	1	1	1	1	1	1	1	1	1	1
25	0	0	0	0	0	0	0	0	0	0	0	0	0	0	0	0	0	0	0	0	0	0			

MAX2550

Band I, V, and VIII WCDMA Femtocell Transceiver with GSM Monitoring

Table 21. RX_LNA Register 3 (Address = 00011)

BIT	BIT ID	NAME	DEFINITION	BIT	BAND I RX1 ONLY	DCS RX2 ONLY	BAND V RX3 ONLY	BAND VIII RX3 ONLY	BAND V RX4 ONLY	BAND VIII RX4 ONLY	BAND I RX5 ONLY	BAND I TXH ONLY	BAND V TXL ONLY	BAND VIII TXL ONLY	BAND I RX1/TXH FDD	BAND V RX3/TXL FDD	BAND VIII RX3/TXL FDD	BAND I RX IDLE	BAND I TX IDLE	AFC ONLY	REFERENCE BUFFER	SLEEP				
				BIT	BAND I RX1 ONLY	DCS RX2 ONLY	BAND V RX3 ONLY	BAND VIII RX3 ONLY	BAND V RX4 ONLY	BAND VIII RX4 ONLY	BAND I RX5 ONLY	BAND I TXH ONLY	BAND V TXL ONLY	BAND VIII TXL ONLY	BAND I RX1/TXH FDD	BAND V RX3/TXL FDD	BAND VIII RX3/TXL FDD	BAND I RX IDLE	BAND I TX IDLE	AFC ONLY	REFERENCE BUFFER	SLEEP				
0	Reserved	Reserved	—	0	0	0	0	0	0	0	0	0	0	0	0	0	0	0	0	0	0	0				
1				1	1	1	1	1	1	1	1	1	1	1	1	1	1	1	1	1	1	1	1	1		
2				2	0	0	0	0	0	0	0	0	0	0	0	0	0	0	0	0	0	0	0	0	0	
3				3	1	1	1	1	1	1	1	1	1	1	1	1	1	1	1	1	1	1	1	1	1	
4				4	0	0	0	0	0	0	0	0	0	0	0	0	0	0	0	0	0	0	0	0	0	
5				5	1	1	1	1	1	1	1	1	1	1	1	1	1	1	1	1	1	1	1	1	1	1
6				6	0	0	0	0	0	0	0	0	0	0	0	0	0	0	0	0	0	0	0	0	0	0
7				7	1	1	1	1	1	1	1	1	1	1	1	1	1	1	1	1	1	1	1	1	1	1
8				8	1	1	1	1	1	1	1	1	1	1	1	1	1	1	1	1	1	1	1	1	1	1
9				9	1	1	1	1	1	1	1	1	1	1	1	1	1	1	1	1	1	1	1	1	1	1
10				10	0	0	0	0	0	0	0	0	0	0	0	0	0	0	0	0	0	0	0	0	0	0
11	RXSYN_RBYP	Rx SYN Ena Rx RF oop Filter bie	Rx RF PLL Loop Filter Adjust 0 = WCDMA 1 = Not used	0	0	0	0	0	0	0	0	0	0	0	0	0	0	0	0	0	0	0	0			
12	Reserved	Reserved	—	1	0	0	0	0	0	0	0	0	0	0	0	0	0	0	0	0	0	0	0			
13				2	0	0	0	0	0	0	0	0	0	0	0	0	0	0	0	0	0	0	0	0	0	
14				3	1	1	1	1	1	1	1	1	1	1	1	1	1	1	1	1	1	1	1	1	1	1
15				4	1	1	1	1	1	1	1	1	1	1	1	1	1	1	1	1	1	1	1	1	1	1
16				5	1	1	1	1	1	1	1	1	1	1	1	1	1	1	1	1	1	1	1	1	1	1

MAX2550

Band I, V, and VIII WCDMA Femtocell Transceiver with GSM Monitoring

Table 21. RX_LNA Register 3 (Address = 00011) (continued)

BIT	BIT ID	NAME	DEFINITION	BIT	BAND I RX1 ONLY	DCS RX2 ONLY	BAND V RX3 ONLY	BAND VIII RX3 ONLY	BAND V RX4 ONLY	BAND VIII RX4 ONLY	BAND I RX5 ONLY	BAND I TXH ONLY	BAND V TXL ONLY	BAND VIII TXL ONLY	BAND I RX1/TXH FDD	BAND V RX3/TXL FDD	BAND VIII RX3/TXL FDD	BAND I RX IDLE	BAND I TX IDLE	AFC ONLY	REFERENCE BUFFER	SLEEP	
17	RVCO_DIV2 <1:0>		Rx RF VCO Prescaler Divide Ratio Configuration <1:0> = 01 = CELL <1:0> = 10 = PCS	6	0	0	1	1	1	1	0	0	1	1	0	1	1	0	0	0	0	0	
18				7	1	1	0	0	0	0	0	1	1	0	0	1	0	0	1	1	1	1	1
19	RVCO_SEL <1:0>	Rx RF VCO Selection	<1:0> = 00 = Disable <1:0> = 01 = ROL (CELL) <1:0> = 10 = ROH (PCS) <1:0> = 11 = Not used	8	0	0	1	0	1	0	1	0	1	0	0	1	0	0	0	0	0	0	
20				9	1	1	0	1	0	1	1	1	0	1	1	0	1	1	1	1	1	1	1
21	RVCOTUNE <1:0>	Rx RF VCO ROH Band Selection	<1:0> = 00 = band2 (IMT) <1:0> = 01 = band3 (PCS) <1:0> = 11 = Not used	10	0	1	1	1	0	1	0	0	0	1	0	1	1	0	0	0	0	0	
22				0	0	1	0	1	0	0	0	0	0	0	1	0	0	1	0	0	0	0	0
23	Reserved	Reserved	—	1	1	1	1	1	1	1	1	1	1	1	1	1	1	1	1	1	1	1	
24				2	0	0	0	0	0	0	0	0	0	0	0	0	0	0	0	0	0	0	0
25				3	0	0	0	0	0	0	0	0	0	0	0	0	0	0	0	0	0	0	0

MAX2550

Band I, V, and VIII WCDMA Femtocell Transceiver with GSM Monitoring

Table 22. Reserved Register 4 (Address = 00100)

BIT	BIT ID	NAME	DEFINITION	BIT	BAND I RX1 ONLY	DCS RX2 ONLY	BAND V RX3 ONLY	BAND VIII RX3 ONLY	BAND V RX4 ONLY	BAND VIII RX4 ONLY	BAND I RX5 ONLY	BAND I TXH ONLY	BAND V TXL ONLY	BAND VIII TXL ONLY	BAND I RX1/TXH FDD	BAND V RX3/TXL FDD	BAND VIII RX3/TXL FDD	BAND I RX IDLE	BAND I TX IDLE	AFC ONLY	REFERENCE BUFFER	SLEEP			
0	Reserved	Reserved	—	0	0	0	0	0	0	0	0	0	0	0	0	0	0	0	0	0	0	0			
1				0	0	0	0	0	0	0	0	0	0	0	0	0	0	0	0	0	0	0	0	0	
2				0	0	0	0	0	0	0	0	0	0	0	0	0	0	0	0	0	0	0	0	0	
3				0	0	0	0	0	0	0	0	0	0	0	0	0	0	0	0	0	0	0	0	0	
4				1	1	1	1	1	1	1	1	1	1	1	1	1	1	1	1	1	1	1	1	1	1
5				0	0	0	0	0	0	0	0	0	0	0	0	0	0	0	0	0	0	0	0	0	0
6				0	0	0	0	0	0	0	0	0	0	0	0	0	0	0	0	0	0	0	0	0	0
7				0	0	0	0	0	0	0	0	0	0	0	0	0	0	0	0	0	0	0	0	0	0
8				0	0	0	0	0	0	0	0	0	0	0	0	0	0	0	0	0	0	0	0	0	0
9				1	1	1	1	1	1	1	1	1	1	1	1	1	1	1	1	1	1	1	1	1	1
10				0	0	0	0	0	0	0	0	0	0	0	0	0	0	0	0	0	0	0	0	0	0
11				1	1	1	1	1	1	1	1	1	1	1	1	1	1	1	1	1	1	1	1	1	1
12				1	1	1	1	1	1	1	1	1	1	1	1	1	1	1	1	1	1	1	1	1	1
13				0	0	0	0	0	0	0	0	0	0	0	0	0	0	0	0	0	0	0	0	0	0
14				0	0	0	0	0	0	0	0	0	0	0	0	0	0	0	0	0	0	0	0	0	0
15				1	1	1	1	1	1	1	1	1	1	1	1	1	1	1	1	1	1	1	1	1	1
16				0	0	0	0	0	0	0	0	0	0	0	0	0	0	0	0	0	0	0	0	0	0
17				1	1	1	1	1	1	1	1	1	1	1	1	1	1	1	1	1	1	1	1	1	1
18				1	1	1	1	1	1	1	1	1	1	1	1	1	1	1	1	1	1	1	1	1	1
19				0	0	0	0	0	0	0	0	0	0	0	0	0	0	0	0	0	0	0	0	0	0
20				0	0	0	0	0	0	0	0	0	0	0	0	0	0	0	0	0	0	0	0	0	0
21				0	0	0	0	0	0	0	0	0	0	0	0	0	0	0	0	0	0	0	0	0	0
22				1	1	1	1	1	1	1	1	1	1	1	1	1	1	1	1	1	1	1	1	1	1
23				1	1	1	1	1	1	1	1	1	1	1	1	1	1	1	1	1	1	1	1	1	1
24				0	0	0	0	0	0	0	0	0	0	0	0	0	0	0	0	0	0	0	0	0	0
25	0	0	0	0	0	0	0	0	0	0	0	0	0	0	0	0	0	0	0	0	0	0			

MAX2550

Band I, V, and VIII WCDMA Femtocell Transceiver with GSM Monitoring

Table 23. Reserved Register 5 (Address = 00101)

BIT	BIT ID	NAME	DEFINITION	BIT	BAND1 RX1 ONLY	DCS RX2 ONLY	BAND V RX3 ONLY	BAND8 RX3 ONLY	BAND5 RX4 ONLY	BAND8 RX4 ONLY	BAND1 RX5 ONLY	BAND1 TXH ONLY	BAND5 TXL ONLY	BAND8 TXL ONLY	BAND1 RX1/TXH FDD	BAND5 RX3/TXL FDD	BAND8 RX3/TXL FDD	BAND1 RX IDLE	BAND1 TX IDLE	AFC ONLY	REFERENCE BUFFER	SLEEP			
0	Reserved	Reserved	1	0	1	1	1	1	1	1	1	1	1	1	1	1	1	1	1	1	1	1			
1				1	1	1	1	1	1	1	1	1	1	1	1	1	1	1	1	1	1	1	1	1	
2				2	1	1	1	1	1	1	1	1	1	1	1	1	1	1	1	1	1	1	1	1	
3				3	1	1	1	1	1	1	1	1	1	1	1	1	1	1	1	1	1	1	1	1	
4				4	0	0	0	0	0	0	0	0	0	0	0	0	0	0	0	0	0	0	0	0	0
5				5	0	0	0	0	0	0	0	0	0	0	0	0	0	0	0	0	0	0	0	0	0
6				6	1	1	1	1	1	1	1	1	1	1	1	1	1	1	1	1	1	1	1	1	1
7				7	1	1	1	1	1	1	1	1	1	1	1	1	1	1	1	1	1	1	1	1	1
8				8	0	0	0	0	0	0	0	0	0	0	0	0	0	0	0	0	0	0	0	0	0
9				9	1	1	1	1	1	1	1	1	1	1	1	1	1	1	1	1	1	1	1	1	1
10				10	0	0	0	0	0	0	0	0	0	0	0	0	0	0	0	0	0	0	0	0	0
11				11	0	0	0	0	0	0	0	0	0	0	0	0	0	0	0	0	0	0	0	0	0
12				12	0	0	0	0	0	0	0	0	0	0	0	0	0	0	0	0	0	0	0	0	0
13				13	0	0	0	0	0	0	0	0	0	0	0	0	0	0	0	0	0	0	0	0	0
14				14	1	1	1	1	1	1	1	1	1	1	1	1	1	1	1	1	1	1	1	1	1
15				15	0	0	0	0	0	0	0	0	0	0	0	0	0	0	0	0	0	0	0	0	0
16				16	1	1	1	1	1	1	1	1	1	1	1	1	1	1	1	1	1	1	1	1	1
17				17	0	0	0	0	0	0	0	0	0	0	0	0	0	0	0	0	0	0	0	0	0
18				18	1	1	1	1	1	1	1	1	1	1	1	1	1	1	1	1	1	1	1	1	1
19				19	0	0	0	0	0	0	0	0	0	0	0	0	0	0	0	0	0	0	0	0	0
20				20	0	0	0	0	0	0	0	0	0	0	0	0	0	0	0	0	0	0	0	0	0
21				21	0	0	0	0	0	0	0	0	0	0	0	0	0	0	0	0	0	0	0	0	0
22				22	0	0	0	0	0	0	0	0	0	0	0	0	0	0	0	0	0	0	0	0	0
23				23	0	0	0	0	0	0	0	0	0	0	0	0	0	0	0	0	0	0	0	0	0
24				24	0	0	0	0	0	0	0	0	0	0	0	0	0	0	0	0	0	0	0	0	0
25				25	0	0	0	0	0	0	0	0	0	0	0	0	0	0	0	0	0	0	0	0	0

MAX2550

Band I, V, and VIII WCDMA Femtocell Transceiver with GSM Monitoring

Table 24. RX_LPF Register 6 (Address = 00110)

BIT	BIT ID	NAME	DEFINITION	BIT	BAND I RX1 ONLY	DCS RX2 ONLY	BAND V RX3 ONLY	BAND VIII RX3 ONLY	BAND V RX4 ONLY	BAND VIII RX4 ONLY	BAND I RX5 ONLY	BAND I TXH ONLY	BAND V TXL ONLY	BAND VIII TXL ONLY	BAND I RX1/TXH FDD	BAND V RX3/TXL FDD	BAND VIII RX3/TXL FDD	BAND I RX IDLE	BAND I TX IDLE	AFC ONLY	REFERENCE BUFFER	SLEEP			
0	Reserved	Reserved	—	0	0	0	0	0	0	0	0	0	0	0	0	0	0	0	0	0	0	0			
1				0	0	0	0	0	0	0	0	0	0	0	0	0	0	0	0	0	0	0	0	0	
2				0	0	0	0	0	0	0	0	0	0	0	0	0	0	0	0	0	0	0	0	0	
3				0	0	0	0	0	0	0	0	0	0	0	0	0	0	0	0	0	0	0	0	0	
4				1	1	1	1	1	1	1	1	1	1	1	1	1	1	1	1	1	1	1	1	1	1
5				0	0	0	0	0	0	0	0	0	0	0	0	0	0	0	0	0	0	0	0	0	0
6				0	0	0	0	0	0	0	0	0	0	0	0	0	0	0	0	0	0	0	0	0	0
7				1	1	1	1	1	1	1	1	1	1	1	1	1	1	1	1	1	1	1	1	1	1
8				0	0	0	0	0	0	0	0	0	0	0	0	0	0	0	0	0	0	0	0	0	0
9				0	0	0	0	0	0	0	0	0	0	0	0	0	0	0	0	0	0	0	0	0	0
10				1	1	1	1	1	1	1	1	1	1	1	1	1	1	1	1	1	1	1	1	1	1
11				0	0	0	0	0	0	0	0	0	0	0	0	0	0	0	0	0	0	0	0	0	0
12				0	0	0	0	0	0	0	0	0	0	0	0	0	0	0	0	0	0	0	0	0	0
13				1	1	1	1	1	1	1	1	1	1	1	1	1	1	1	1	1	1	1	1	1	1
14				0	0	0	0	0	0	0	0	0	0	0	0	0	0	0	0	0	0	0	0	0	0
15				1	1	1	1	1	1	1	1	1	1	1	1	1	1	1	1	1	1	1	1	1	1
16				0	0	0	1	0	1	0	1	0	0	0	0	1	0	0	1	0	0	0	0	0	0
17	LPFBYPASS	Rx LPF Bypass	0 = Normal operation 1 = Bypass Rx LPF	0	0	0	0	0	0	0	0	0	0	0	0	0	0	0	0	0	0	0			
18	Reserved	Reserved	—	0	0	0	0	0	0	0	0	0	0	0	0	0	0	0	0	0	0	0			
19				0	0	0	0	0	0	0	0	0	0	0	0	0	0	0	0	0	0	0	0	0	
20				0	0	0	0	0	0	0	0	0	0	0	0	0	0	0	0	0	0	0	0	0	
21				0	0	0	0	0	0	0	0	0	0	0	0	0	0	0	0	0	0	0	0	0	
22				0	0	0	0	0	0	0	0	0	0	0	0	0	0	0	0	0	0	0	0	0	0
23	BBMODE	Rx LPF Bandwidth Select	000 = WCDMA 011 = GSM	0	0	1	0	0	0	0	0	0	0	0	0	0	0	0	0	0	0	0	0		
24				1	0	1	0	0	0	0	0	0	0	0	0	0	0	0	0	0	0	0	0	0	
25				0	0	0	0	0	0	0	0	0	0	0	0	0	0	0	0	0	0	0	0	0	

MAX2550

Band I, V, and VIII WCDMA Femtocell Transceiver with GSM Monitoring

Table 25. GPO_CONFIG Register 7 (Address = 00111)

BIT	BIT ID	NAME	DEFINITION	BIT	BAND I RX1 ONLY	DCS RX2 ONLY	BAND V RX3 ONLY	BAND VIII RX3 ONLY	BAND V RX4 ONLY	BAND VIII RX4 ONLY	BAND I RX5 ONLY	BAND I TXH ONLY	BAND V TXL ONLY	BAND VIII TXL ONLY	BAND I RX1/TXH FDD	BAND V RX3/TXL FDD	BAND VIII RX3/TXL FDD	BAND I RX IDLE	BAND I TX IDLE	AFC ONLY	REFERENCE BUFFER	SLEEP	
0	Reserved	Reserved	—	0	0	0	0	0	0	0	0	0	0	0	0	0	0	0	0	0	0	0	
1	GPO3_LD_RD_sel_LSB		GPO3 Output Mux Select LSB MSB in REG7<17> 00 = RXPLL LD 01 = TXPLL LD 10 = Output selected by GPO3<1:0> 11 = RXPLL LD and TXPLL LD and CLKPLL LD	0	0	0	0	0	0	0	0	0	0	0	0	0	0	0	0	0	0	0	0
2	GPO2<1:0>	GPO2 GPO2 Output Select Select	<1:0> = 00 = High-Z <1:0> = 01 = High-Z <1:0> = 10 = Low-Z low <1:0> = 11 = Low-Z high	0	1	1	1	1	1	1	1	1	1	1	1	1	1	1	1	1	1	1	1
3				1	0	0	0	0	0	0	0	0	0	0	0	0	0	0	0	0	0	0	0
4	GPO3<1:0>	GPO3 Output Select	<1:0> = 00 = High-Z <1:0> = 01 = High-Z <1:0> = 10 = Low-Z low <1:0> = 11 = Low-Z high		1	1	1	1	1	1	1	1	1	1	1	1	1	1	1	1	1	1	1
5				1	0	0	0	0	0	0	0	0	0	0	0	0	0	0	0	0	0	0	0
6	TS_TRIG	Temperature Sensor Reading Trigger	0 = Not trigger reading 1 = Trigger reading	0	0	0	0	0	0	0	0	0	0	0	0	0	0	0	0	0	0	0	0

MAX2550

Band I, V, and VIII WCDMA Femtocell Transceiver with GSM Monitoring

Table 25. GPO_CONFIG Register 7 (Address = 00111) (continued)

BIT	BIT ID	NAME	DEFINITION	BIT	BAND I RX1 ONLY	DCS RX2 ONLY	BAND V RX3 ONLY	BAND VIII RX3 ONLY	BAND V RX4 ONLY	BAND VIII RX4 ONLY	BAND I RX5 ONLY	BAND I TXH ONLY	BAND V TXL ONLY	BAND VIII TXL ONLY	BAND I RX1/TXH FDD	BAND V RX3/TXL FDD	BAND VIII RX3/TXL FDD	BAND I RX IDLE	BAND I TX IDLE	AFC ONLY	REFERENCE BUFFER	SLEEP				
				BIT	BAND I RX1 ONLY	DCS RX2 ONLY	BAND V RX3 ONLY	BAND VIII RX3 ONLY	BAND V RX4 ONLY	BAND VIII RX4 ONLY	BAND I RX5 ONLY	BAND I TXH ONLY	BAND V TXL ONLY	BAND VIII TXL ONLY	BAND I RX1/TXH FDD	BAND V RX3/TXL FDD	BAND VIII RX3/TXL FDD	BAND I RX IDLE	BAND I TX IDLE	AFC ONLY	REFERENCE BUFFER	SLEEP				
7	Temperature Sensor Output	Temperature Sensor Output	To be read at DOUT pin through SPI readback	0	0	0	0	0	0	0	0	0	0	0	0	0	0	0	0	0	0	0				
8				1	0	0	0	0	0	0	0	0	0	0	0	0	0	0	0	0	0	0	0	0		
9				2	0	0	0	0	0	0	0	0	0	0	0	0	0	0	0	0	0	0	0	0	0	
10				3	0	0	0	0	0	0	0	0	0	0	0	0	0	0	0	0	0	0	0	0	0	0
11				4	0	0	0	0	0	0	0	0	0	0	0	0	0	0	0	0	0	0	0	0	0	0
12	Reserved	Reserved	—	0	0	0	0	0	0	0	0	0	0	0	0	0	0	0	0	0	0	0	0			
13				1	0	0	0	0	0	0	0	0	0	0	0	0	0	0	0	0	0	0	0	0	0	
14				2	1	1	1	1	1	1	1	1	1	1	1	1	1	1	1	1	1	1	1	1	1	1
15				3	0	0	0	0	0	0	0	0	0	0	0	0	0	0	0	0	0	0	0	0	0	0
16				4	1	1	1	1	1	1	1	1	1	1	1	1	1	1	1	1	1	1	1	1	1	1
17	GPO3_LD_RD_sel_MSB	GPO3 Output Mux Select MSB LSB in REG7<1> 00 = RXPLL LD 01 = TXPLL LD 10 = Output selected by GPO3<0:1> 11 = RXPLL LD and TXPLL LD and CLKPLL LD	0	0	0	0	0	0	0	0	0	0	0	0	0	0	0	0	0	0	0	0				
18	Reserved	Reserved	—	0	1	1	1	1	1	1	1	1	1	1	1	1	1	1	1	1	1	1	1			
19				1	1	1	1	1	1	1	1	1	1	1	1	1	1	1	1	1	1	1	1	1		
20	DOUT_DRV<1:0>	DOUT Drive Strength	<1:0> = 00 = 1x <1:0> = 01 = 2x <1:0> = 10 = 3x <1:0> = 11 = 4x	0	1	1	1	1	1	1	1	1	1	1	1	1	1	1	1	1	1	1				
21				1	1	1	1	1	1	1	1	1	1	1	1	1	1	1	1	1	1	1	1	1		
22	Reserved	Reserved	—	0	0	0	0	0	0	0	0	0	0	0	0	0	0	0	0	0	0	0				
23				1	0	0	0	0	0	0	0	0	0	0	0	0	0	0	0	0	0	0	0	0		
24				2	0	0	0	0	0	0	0	0	0	0	0	0	0	0	0	0	0	0	0	0	0	
25				3	0	0	0	0	0	0	0	0	0	0	0	0	0	0	0	0	0	0	0	0	0	

MAX2550

Band I, V, and VIII WCDMA Femtocell Transceiver with GSM Monitoring

Table 26. Reserved Register 8 (Address = 01000)

BIT	BIT ID	NAME	DEFINITION	BIT	BAND I RX1 ONLY	DCS RX2 ONLY	BAND V RX3 ONLY	BAND VIII RX3 ONLY	BAND V RX4 ONLY	BAND VIII RX4 ONLY	BAND I RX5 ONLY	BAND I TXH ONLY	BAND V TXL ONLY	BAND VIII TXL ONLY	BAND I RX1/TXH FDD	BAND V RX3/TXL FDD	BAND VIII RX3/TXL FDD	BAND I RX IDLE	BAND I TX IDLE	AFC ONLY	REFERENCE BUFFER	SLEEP			
0	Reserved	Reserved	-	0	0	0	0	0	0	0	0	0	0	0	0	0	0	0	0	0	0	0			
1				0	0	0	0	0	0	0	0	0	0	0	0	0	0	0	0	0	0	0	0	0	
2				0	0	0	0	0	0	0	0	0	0	0	0	0	0	0	0	0	0	0	0	0	
3				0	0	0	0	0	0	0	0	0	0	0	0	0	0	0	0	0	0	0	0	0	
4				0	0	0	0	0	0	0	0	0	0	0	0	0	0	0	0	0	0	0	0	0	
5				0	0	0	0	0	0	0	0	0	0	0	0	0	0	0	0	0	0	0	0	0	0
6				0	0	0	0	0	0	0	0	0	0	0	0	0	0	0	0	0	0	0	0	0	0
7				0	0	0	0	0	0	0	0	0	0	0	0	0	0	0	0	0	0	0	0	0	0
8				0	0	0	0	0	0	0	0	0	0	0	0	0	0	0	0	0	0	0	0	0	0
9				0	0	0	0	0	0	0	0	0	0	0	0	0	0	0	0	0	0	0	0	0	0
10				0	0	0	0	0	0	0	0	0	0	0	0	0	0	0	0	0	0	0	0	0	0
11				0	0	0	0	0	0	0	0	0	0	0	0	0	0	0	0	0	0	0	0	0	0
12				0	0	0	0	0	0	0	0	0	0	0	0	0	0	0	0	0	0	0	0	0	0
13				0	0	0	0	0	0	0	0	0	0	0	0	0	0	0	0	0	0	0	0	0	0
14				0	0	0	0	0	0	0	0	0	0	0	0	0	0	0	0	0	0	0	0	0	0
15				0	0	0	0	0	0	0	0	0	0	0	0	0	0	0	0	0	0	0	0	0	0
16				0	0	0	0	0	0	0	0	0	0	0	0	0	0	0	0	0	0	0	0	0	0
17				0	0	0	0	0	0	0	0	0	0	0	0	0	0	0	0	0	0	0	0	0	0
18				0	0	0	0	0	0	0	0	0	0	0	0	0	0	0	0	0	0	0	0	0	0
19				0	0	0	0	0	0	0	0	0	0	0	0	0	0	0	0	0	0	0	0	0	0
20				0	0	0	0	0	0	0	0	0	0	0	0	0	0	0	0	0	0	0	0	0	0
21				0	0	0	0	0	0	0	0	0	0	0	0	0	0	0	0	0	0	0	0	0	0
22				0	0	0	0	0	0	0	0	0	0	0	0	0	0	0	0	0	0	0	0	0	0
23				0	0	0	0	0	0	0	0	0	0	0	0	0	0	0	0	0	0	0	0	0	0
24				0	0	0	0	0	0	0	0	0	0	0	0	0	0	0	0	0	0	0	0	0	0
25				0	0	0	0	0	0	0	0	0	0	0	0	0	0	0	0	0	0	0	0	0	0

MAX2550

Band I, V, and VIII WCDMA Femtocell Transceiver with GSM Monitoring

Table 27. Reserved Register 9 (Address = 01001)

BIT	BIT ID	NAME	DEFINITION	BIT	BAND I RX1 ONLY	DCS RX2 ONLY	BAND V RX3 ONLY	BAND VIII RX3 ONLY	BAND V RX4 ONLY	BAND VIII RX4 ONLY	BAND I RX5 ONLY	BAND I TXH ONLY	BAND V TXL ONLY	BAND VIII TXL ONLY	BAND I RX1/TXH FDD	BAND V RX3/TXL FDD	BAND VIII RX3/TXL FDD	BAND I RX IDLE	BAND I TX IDLE	AFC ONLY	REFERENCE BUFFER	SLEEP			
0	Reserved	Reserved	-	0	0	0	0	0	0	0	0	0	0	0	0	0	0	0	0	0	0	0			
1				0	0	0	0	0	0	0	0	0	0	0	0	0	0	0	0	0	0	0	0	0	
2				0	0	0	0	0	0	0	0	0	0	0	0	0	0	0	0	0	0	0	0	0	0
3				0	0	0	0	0	0	0	0	0	0	0	0	0	0	0	0	0	0	0	0	0	0
4				0	0	0	0	0	0	0	0	0	0	0	0	0	0	0	0	0	0	0	0	0	0
5				0	0	0	0	0	0	0	0	0	0	0	0	0	0	0	0	0	0	0	0	0	0
6				0	0	0	0	0	0	0	0	0	0	0	0	0	0	0	0	0	0	0	0	0	0
7				0	0	0	0	0	0	0	0	0	0	0	0	0	0	0	0	0	0	0	0	0	0
8				0	0	0	0	0	0	0	0	0	0	0	0	0	0	0	0	0	0	0	0	0	0
9				0	0	0	0	0	0	0	0	0	0	0	0	0	0	0	0	0	0	0	0	0	0
10				0	0	0	0	0	0	0	0	0	0	0	0	0	0	0	0	0	0	0	0	0	0
11				0	0	0	0	0	0	0	0	0	0	0	0	0	0	0	0	0	0	0	0	0	0
12				0	0	0	0	0	0	0	0	0	0	0	0	0	0	0	0	0	0	0	0	0	0
13				0	0	0	0	0	0	0	0	0	0	0	0	0	0	0	0	0	0	0	0	0	0
14				0	0	0	0	0	0	0	0	0	0	0	0	0	0	0	0	0	0	0	0	0	0
15				0	0	0	0	0	0	0	0	0	0	0	0	0	0	0	0	0	0	0	0	0	0
16				0	0	0	0	0	0	0	0	0	0	0	0	0	0	0	0	0	0	0	0	0	0
17				0	0	0	0	0	0	0	0	0	0	0	0	0	0	0	0	0	0	0	0	0	0
18				0	0	0	0	0	0	0	0	0	0	0	0	0	0	0	0	0	0	0	0	0	0
19				0	0	0	0	0	0	0	0	0	0	0	0	0	0	0	0	0	0	0	0	0	0
20				0	0	0	0	0	0	0	0	0	0	0	0	0	0	0	0	0	0	0	0	0	0
21				0	0	0	0	0	0	0	0	0	0	0	0	0	0	0	0	0	0	0	0	0	0
22				0	0	0	0	0	0	0	0	0	0	0	0	0	0	0	0	0	0	0	0	0	0
23				0	0	0	0	0	0	0	0	0	0	0	0	0	0	0	0	0	0	0	0	0	0
24				0	0	0	0	0	0	0	0	0	0	0	0	0	0	0	0	0	0	0	0	0	0
25	0	0	0	0	0	0	0	0	0	0	0	0	0	0	0	0	0	0	0	0	0	0			

MAX2550

Band I, V, and VIII WCDMA Femtocell Transceiver with GSM Monitoring

Table 28. RXLO_FRAC Register 10 (Address = 01010)

BIT	BIT ID	NAME	DEFINITION	BIT	BAND I RX1 ONLY	DCS RX2 ONLY	BAND V RX3 ONLY	BAND VIII RX3 ONLY	BAND V RX4 ONLY	BAND VIII RX4 ONLY	BAND I RX5 ONLY	BAND I TXH ONLY	BAND V TXL ONLY	BAND VIII TXL ONLY	BAND I RX1/TXH FDD	BAND V RX3/TXL FDD	BAND VIII RX3/TXL FDD	BAND I RX IDLE	BAND I TX IDLE	AFC ONLY	REFERENCE BUFFER	SLEEP							
0	RFFRAC <19:0>	Receiver RF Synthesizer Fractional Division Ratio	See the RF Synthesizers section	0	0	0	0	0	0	0	1	0	0	0	0	0	0	0	0	0	0	0							
1				0	1	1	1	1	1	1	0	0	1	1	0	1	1	0	0	0	0	0	0	0					
2				0	0	0	0	0	0	0	0	0	1	0	0	0	0	0	0	0	0	0	0	0	0	0			
3				0	1	1	1	1	1	1	1	0	0	0	1	1	0	1	1	0	0	0	0	0	0	0	0		
4				0	0	0	0	0	0	0	0	0	1	0	0	0	0	0	0	0	0	0	0	0	0	0	0	0	
5				0	1	1	1	1	1	1	1	1	0	0	0	1	1	0	1	1	0	0	0	0	0	0	0	0	
6				0	0	0	0	0	0	0	0	0	0	1	0	0	0	0	0	0	0	0	0	0	0	0	0	0	
7				0	1	1	1	1	1	1	1	1	0	0	0	1	1	0	1	1	0	0	0	0	0	0	0	0	0
8				0	0	0	0	0	0	0	0	0	0	1	0	0	0	0	0	0	0	0	0	0	0	0	0	0	0
9				0	1	1	1	1	1	1	1	1	0	0	0	1	1	0	1	1	0	0	0	0	0	0	0	0	0
10				0	0	0	0	0	0	0	0	0	0	1	0	0	0	0	0	0	0	0	0	0	0	0	0	0	0
11				0	1	1	1	1	1	1	1	1	0	0	0	1	1	0	1	1	0	0	0	0	0	0	0	0	0
12				0	0	0	0	0	0	0	0	0	0	1	0	0	0	0	0	0	0	0	0	0	0	0	0	0	0
13				0	1	1	1	1	1	1	1	1	0	0	0	1	1	0	1	1	0	0	0	0	0	0	0	0	0
14				0	1	0	0	0	0	0	0	0	0	1	0	0	0	0	0	0	0	0	0	0	0	0	0	0	0
15				0	0	1	1	1	1	1	1	1	0	0	0	1	1	0	1	1	0	0	0	0	0	0	0	0	0
16				1	1	1	1	1	1	1	1	0	0	1	1	1	1	1	1	1	1	1	1	1	1	1	1	1	1
17				0	1	1	1	1	1	1	1	1	1	1	0	1	1	0	1	1	0	0	0	0	0	0	0	0	0
18				0	1	1	0	0	0	0	0	0	1	1	0	0	0	1	0	0	0	0	0	0	0	0	0	0	0
19				1	1	1	0	0	0	0	0	0	1	1	0	0	0	1	0	0	1	1	1	1	1	1	1	1	1
20	Reserved	—	—	0	1	1	1	1	1	1	1	1	1	1	1	1	1	1	1	1	1	1	1	1	1	1			
21				0	0	0	0	0	0	0	0	0	0	0	0	0	0	0	0	0	0	0	0	0	0	0	0	0	
22				0	0	0	0	0	0	0	0	0	0	0	0	0	0	0	0	0	0	0	0	0	0	0	0	0	0
23				0	0	0	0	0	0	0	0	0	0	0	0	0	0	0	0	0	0	0	0	0	0	0	0	0	0
24				0	0	0	0	0	0	0	0	0	0	0	0	0	0	0	0	0	0	0	0	0	0	0	0	0	0
25				1	1	1	1	1	1	1	1	1	1	1	1	1	1	1	1	1	1	1	1	1	1	1	1	1	1

MAX2550

Band I, V, and VIII WCDMA Femtocell Transceiver with GSM Monitoring

Table 29. RXLO_SYN Register 11 (Address = 01011)

BIT	BIT ID	NAME	DEFINITION	BIT	BAND I RX1 ONLY	DCS RX2 ONLY	BAND V RX3 ONLY	BAND VIII RX3 ONLY	BAND V RX4 ONLY	BAND VIII RX4 ONLY	BAND I RX5 ONLY	BAND I TXH ONLY	BAND V TXL ONLY	BAND VIII TXL ONLY	BAND I RX1/TXH FDD	BAND V RX3/TXL FDD	BAND VIII RX3/TXL FDD	BAND I RX IDLE	BAND I TX IDLE	AFC ONLY	REFERENCE BUFFER	SLEEP		
0	RINT<7:0>	Rx RF PLL Integer Divide Ratio	See the <i>RF Synthesizers</i> section	0	1	1	0	1	1	1	1	1	0	1	1	0	1	1	1	1	1	1		
1				0	0	1	1	0	1	0	1	0	1	0	0	1	0	0	0	0	0	0	0	
2				0	1	1	1	1	0	0	1	1	1	1	1	1	1	1	1	1	1	1	1	1
3				0	0	1	0	1	1	0	1	0	0	0	1	0	0	0	1	0	0	0	0	0
4				0	0	1	1	1	1	0	0	0	0	0	1	1	0	1	1	0	0	0	0	0
5				0	1	0	0	0	0	0	1	1	1	1	0	0	1	0	0	1	1	1	1	1
6				0	1	1	1	1	1	1	1	1	1	1	1	1	1	1	1	1	1	1	1	1
7				0	0	0	0	0	0	0	0	0	0	0	0	0	0	0	0	0	0	0	0	0
8	RRD	Rx Reference Divide Ratio	0 = Divide-by-1 1 = Divide-by-2	0	0	0	0	0	0	0	0	0	0	0	0	0	0	0	0	0	0	0		
9	Reserved	Reserved	—	0	1	1	1	1	1	1	1	1	1	1	1	1	1	1	1	1	1	1		
10				0	1	1	1	1	1	1	1	1	1	1	1	1	1	1	1	1	1	1	1	
11				0	1	1	1	1	1	1	1	1	1	1	1	1	1	1	1	1	1	1	1	
12				0	0	0	0	0	0	0	0	0	0	0	0	0	0	0	0	0	0	0	0	
13				0	0	0	0	0	0	0	0	0	0	0	0	0	0	0	0	0	0	0	0	
14				0	0	0	0	0	0	0	0	0	0	0	0	0	0	0	0	0	0	0	0	
15				0	0	0	0	0	0	0	0	0	0	0	0	0	0	0	0	0	0	0	0	
16				0	0	0	0	0	0	0	0	0	0	0	0	0	0	0	0	0	0	0	0	
17				0	0	0	0	0	0	0	0	0	0	0	0	0	0	0	0	0	0	0	0	
18	RCPI<2:0>	Rx PLL Charge-Pump Current	Rx RF PLL Charge-Pump Current 000 = Not used 001 = 200µA 011 = 600µA 110 = 1200µA	0	1	1	1	1	1	1	1	1	1	1	1	1	1	1	1	1	1	1		
19				0	1	1	1	1	1	1	1	1	1	1	1	1	1	1	1	1	1	1	1	
20				1	0	0	0	0	0	0	0	0	0	0	0	0	0	0	0	0	0	0	0	
21	Reserved	Reserved	—	2	0	0	0	0	0	0	0	0	0	0	0	0	0	0	0	0	0	0		
22				3	0	0	0	0	0	0	0	0	0	0	0	0	0	0	0	0	0	0		
23				4	1	1	1	1	1	1	1	1	1	1	1	1	1	1	1	1	1	1	1	
24				5	1	1	1	1	1	1	1	1	1	1	1	1	1	1	1	1	1	1	1	
25				6	0	0	0	0	0	0	0	0	0	0	0	0	0	0	0	0	0	0	0	

MAX2550

Band I, V, and VIII WCDMA Femtocell Transceiver with GSM Monitoring

Table 30. BBCLK_OUT Register 12 (Address = 01100)

BIT	BIT ID	NAME	DEFINITION	BIT	BAND I RX1 ONLY	DCS RX2 ONLY	BAND V RX3 ONLY	BAND VIII RX3 ONLY	BAND V RX4 ONLY	BAND VIII RX4 ONLY	BAND I RX5 ONLY	BAND I TXH ONLY	BAND V TXL ONLY	BAND VIII TXL ONLY	BAND I RX1/TXH FDD	BAND V RX3/TXL FDD	BAND VIII RX3/TXL FDD	BAND I RX IDLE	BAND I TX IDLE	AFC ONLY	REFERENCE BUFFER	SLEEP				
0	ADF<2:0>	ADC Clock Divide Ratio	000 = 1 for WCDMA 001 = Not used 010 = Not used 011 = 6 for GSM 100~111 = Not used	0	0	1	0	0	0	0	0	0	0	0	0	0	0	0	0	0	0	0				
1				1	0	1	0	0	0	0	0	0	0	0	0	0	0	0	0	0	0	0	0			
2				2	0	0	0	0	0	0	0	0	0	0	0	0	0	0	0	0	0	0	0	0		
3	Reserved	Reserved	—	0	1	1	1	1	1	1	1	1	1	1	1	1	1	1	1	1	1	1	1			
4				1	0	0	0	0	0	0	0	0	0	0	0	0	0	0	0	0	0	0	0	0		
5				2	0	0	0	0	0	0	0	0	0	0	0	0	0	0	0	0	0	0	0	0	0	
6				3	0	0	0	0	0	0	0	0	0	0	0	0	0	0	0	0	0	0	0	0	0	0
7				4	0	0	0	0	0	0	0	0	0	0	0	0	0	0	0	0	0	0	0	0	0	0
8	5	0	0	0	0	0	0	0	0	0	0	0	0	0	0	0	0	0	0	0	0	0	0			
9	LVDSL2X	RxBB LVDS 2X Current Enable	0 = 220Ω load 1 = 100Ω load	0	1	1	1	1	1	1	1	1	1	1	1	1	1	1	1	1	1	1	1			
10	Reserved	Reserved	—	0	1	1	1	1	1	1	1	1	1	1	1	1	1	1	1	1	1	1	1			
11				1	1	1	1	1	1	1	1	1	1	1	1	1	1	1	1	1	1	1	1	1	1	
12				2	0	0	0	0	0	0	0	0	0	0	0	0	0	0	0	0	0	0	0	0	0	0
13				3	0	0	0	0	0	0	0	0	0	0	0	0	0	0	0	0	0	0	0	0	0	0
14				4	0	0	0	0	0	0	0	0	0	0	0	0	0	0	0	0	0	0	0	0	0	0
15				5	0	0	0	0	0	0	0	0	0	0	0	0	0	0	0	0	0	0	0	0	0	0
16				6	0	0	0	0	0	0	0	0	0	0	0	0	0	0	0	0	0	0	0	0	0	0
17				7	0	0	0	0	0	0	0	0	0	0	0	0	0	0	0	0	0	0	0	0	0	0
18				8	0	0	0	0	0	0	0	0	0	0	0	0	0	0	0	0	0	0	0	0	0	0
19				9	0	0	0	0	0	0	0	0	0	0	0	0	0	0	0	0	0	0	0	0	0	0
20				10	1	1	1	1	1	1	1	1	1	1	1	1	1	1	1	1	1	1	1	1	1	1
21				11	0	0	0	0	0	0	0	0	0	0	0	0	0	0	0	0	0	0	0	0	0	0
22				12	0	0	0	0	0	0	0	0	0	0	0	0	0	0	0	0	0	0	0	0	0	0
23				13	0	0	0	0	0	0	0	0	0	0	0	0	0	0	0	0	0	0	0	0	0	0
24				14	0	0	0	0	0	0	0	0	0	0	0	0	0	0	0	0	0	0	0	0	0	0
25				15	1	1	1	1	1	1	1	1	1	1	1	1	1	1	1	1	1	1	1	1	1	1

MAX2550

Band I, V, and VIII WCDMA Femtocell Transceiver with GSM Monitoring

Table 31. Reserved Register 13 (Address = 01101)

BIT	BIT ID	NAME	DEFINITION	BIT	BAND I RX1 ONLY	DCS RX2 ONLY	BAND V RX3 ONLY	BAND VIII RX3 ONLY	BAND V RX4 ONLY	BAND VIII RX4 ONLY	BAND I RX5 ONLY	BAND I TXH ONLY	BAND V TXL ONLY	BAND VIII TXL ONLY	BAND I RX1/TXH FDD	BAND V RX3/TXL FDD	BAND VIII RX3/TXL FDD	BAND I RX IDLE	BAND I TX IDLE	AFC ONLY	REFERENCE BUFFER	SLEEP			
0	Reserved	Reserved	-	0	0	0	0	0	0	0	0	0	0	0	0	0	0	0	0	0	0	0			
1				0	0	0	0	0	0	0	0	0	0	0	0	0	0	0	0	0	0	0	0	0	
2				0	1	1	1	1	1	1	1	1	1	1	1	1	1	1	1	1	1	1	1	1	1
3				1	0	0	0	0	0	0	0	0	0	0	0	0	0	0	0	0	0	0	0	0	0
4				2	0	0	0	0	0	0	0	0	0	0	0	0	0	0	0	0	0	0	0	0	0
5				3	1	1	1	1	1	1	1	1	1	1	1	1	1	1	1	1	1	1	1	1	1
6				0	1	1	1	1	1	1	1	1	1	1	1	1	1	1	1	1	1	1	1	1	1
7				1	0	0	0	0	0	0	0	0	0	0	0	0	0	0	0	0	0	0	0	0	0
8				2	0	0	0	0	0	0	0	0	0	0	0	0	0	0	0	0	0	0	0	0	0
9				3	0	0	0	0	0	0	0	0	0	0	0	0	0	0	0	0	0	0	0	0	0
10				4	0	0	0	0	0	0	0	0	0	0	0	0	0	0	0	0	0	0	0	0	0
11				5	1	1	1	1	1	1	1	1	1	1	1	1	1	1	1	1	1	1	1	1	1
12				0	1	1	1	1	1	1	1	1	1	1	1	1	1	1	1	1	1	1	1	1	1
13				0	1	1	1	1	1	1	1	1	1	1	1	1	1	1	1	1	1	1	1	1	1
14				0	1	1	1	1	1	1	1	1	1	1	1	1	1	1	1	1	1	1	1	1	1
15				1	1	1	1	1	1	1	1	1	1	1	1	1	1	1	1	1	1	1	1	1	1
16				2	0	0	0	0	0	0	0	0	0	0	0	0	0	0	0	0	0	0	0	0	0
17				0	1	1	1	1	1	1	1	1	1	1	1	1	1	1	1	1	1	1	1	1	1
18				1	1	1	1	1	1	1	1	1	1	1	1	1	1	1	1	1	1	1	1	1	1
19				2	0	0	0	0	0	0	0	0	0	0	0	0	0	0	0	0	0	0	0	0	0
20				0	0	0	0	0	0	0	0	0	0	0	0	0	0	0	0	0	0	0	0	0	0
21				0	0	0	0	0	0	0	0	0	0	0	0	0	0	0	0	0	0	0	0	0	0
22				0	0	0	0	0	0	0	0	0	0	0	0	0	0	0	0	0	0	0	0	0	0
23				0	0	0	0	0	0	0	0	0	0	0	0	0	0	0	0	0	0	0	0	0	0
24				0	0	0	0	0	0	0	0	0	0	0	0	0	0	0	0	0	0	0	0	0	0
25				0	0	0	0	0	0	0	0	0	0	0	0	0	0	0	0	0	0	0	0	0	0

MAX2550

Band I, V, and VIII WCDMA Femtocell Transceiver with GSM Monitoring

Table 32. BBCLK_FRAC Register 14 (Address = 01110)

BIT	BIT ID	NAME	DEFINITION	BIT	BAND I RX1 ONLY	DCS RX2 ONLY	BAND V RX3 ONLY	BAND VIII RX3 ONLY	BAND V RX4 ONLY	BAND VIII RX4 ONLY	BAND I RX5 ONLY	BAND I TXH ONLY	BAND V TXL ONLY	BAND VIII TXL ONLY	BAND I RX1/TXH FDD	BAND V RX3/TXL FDD	BAND VIII RX3/TXL FDD	BAND I RX IDLE	BAND I TX IDLE	AFC ONLY	REFERENCE BUFFER	SLEEP			
0	CFRAC <19:0>	ADC Clock PLL Fractional Divide Ratio	GSM: For $f_{REFIN} =$ 13.0MHz = 00000 (hex) 15.36MHz = 40000 (hex) 19.2MHz = 00000 (hex) 26.0MHz = 00000 (hex)	0	0	0	0	0	0	0	0	0	0	0	0	0	0	0	0	0	0	0			
1				0	0	0	0	0	0	0	0	0	0	0	0	0	0	0	0	0	0	0	0	0	
2				0	0	0	0	0	0	0	0	0	0	0	0	0	0	0	0	0	0	0	0	0	0
3				0	0	0	0	0	0	0	0	0	0	0	0	0	0	0	0	0	0	0	0	0	0
4				0	0	0	0	0	0	0	0	0	0	0	0	0	0	0	0	0	0	0	0	0	0
5				0	0	0	0	0	0	0	0	0	0	0	0	0	0	0	0	0	0	0	0	0	0
6				0	0	0	0	0	0	0	0	0	0	0	0	0	0	0	0	0	0	0	0	0	0
7				0	0	0	0	0	0	0	0	0	0	0	0	0	0	0	0	0	0	0	0	0	0
8				0	0	0	0	0	0	0	0	0	0	0	0	0	0	0	0	0	0	0	0	0	0
9				0	0	0	0	0	0	0	0	0	0	0	0	0	0	0	0	0	0	0	0	0	0
10				0	0	0	0	0	0	0	0	0	0	0	0	0	0	0	0	0	0	0	0	0	0
11				0	0	0	0	0	0	0	0	0	0	0	0	0	0	0	0	0	0	0	0	0	0
12				0	0	0	0	0	0	0	0	0	0	0	0	0	0	0	0	0	0	0	0	0	0
13				0	0	0	0	0	0	0	0	0	0	0	0	0	0	0	0	0	0	0	0	0	0
14				0	0	0	0	0	0	0	0	0	0	0	0	0	0	0	0	0	0	0	0	0	0
15				0	0	0	0	0	0	0	0	0	0	0	0	0	0	0	0	0	0	0	0	0	0
16				0	0	0	0	0	0	0	0	0	0	0	0	0	0	0	0	0	0	0	0	0	0
17				0	0	0	0	0	0	0	0	0	0	0	0	0	0	0	0	0	0	0	0	0	0
18				0	0	0	0	0	0	0	0	0	0	0	0	0	0	0	0	0	0	0	0	0	0
19				0	0	0	0	0	0	0	0	0	0	0	0	0	0	0	0	0	0	0	0	0	0
20	Reserved	Reserved	WCDMA: For $f_{REFIN} =$ 13.0MHz = 85E85 (hex) 15.36MHz = 00000 (hex) 19.2MHz = 00000 (hex) 26.0MHz = 42F4s (hex)	0	1	1	1	1	1	1	1	1	1	1	1	1	1	1	1	1	1	1			
21				0	0	0	0	0	0	0	0	0	0	0	0	0	0	0	0	0	0	0	0	0	
22				0	0	0	0	0	0	0	0	0	0	0	0	0	0	0	0	0	0	0	0	0	0
23				0	0	0	0	0	0	0	0	0	0	0	0	0	0	0	0	0	0	0	0	0	0
24				0	0	0	0	0	0	0	0	0	0	0	0	0	0	0	0	0	0	0	0	0	0
25				1	1	1	1	1	1	1	1	1	1	1	1	1	1	1	1	1	1	1	1	1	1

MAX2550

Band I, V, and VIII WCDMA Femtocell Transceiver with GSM Monitoring

Table 33. BBCLK SYN Register 15 (Address = 01111)

BIT	BIT ID	NAME	DEFINITION	BIT																								
				BAND I RX1 ONLY	DCS RX2 ONLY	BAND V RX3 ONLY	BAND VIII RX3 ONLY	BAND V RX4 ONLY	BAND VIII RX4 ONLY	BAND I RX5 ONLY	BAND I TXH ONLY	BAND V TXL ONLY	BAND VIII TXL ONLY	BAND I RX1/TXH FDD	BAND V RX3/TXL FDD	BAND VIII RX3/TXL FDD	BAND I RX IDLE	BAND I TX IDLE	AFC ONLY	REFERENCE BUFFER	SLEEP							
0	CINT<7:0>	ADC Clock PLL Integer Divide Ratio	GSM: For f _{REFIN} = 13.0MHz = 60 (hex) 15.36MHz = 51 (hex) 19.2MHz = 41 (hex) 26.0MHz = 30 (hex)	0	0	1	0	0	0	0	0	0	0	0	0	0	0	0	0	0	0	0	0	0	0			
1				1	0	0	0	0	0	0	0	0	0	0	0	0	0	0	0	0	0	0	0	0	0	0		
2				2	0	0	0	0	0	0	0	0	0	0	0	0	0	0	0	0	0	0	0	0	0	0	0	
3				3	0	0	0	0	0	0	0	0	0	0	0	0	0	0	0	0	0	0	0	0	0	0	0	0
4				4	0	0	0	0	0	0	0	0	0	0	0	0	0	0	0	0	0	0	0	0	0	0	0	0
5				5	0	0	0	0	0	0	0	0	0	0	0	0	0	0	0	0	0	0	0	0	0	0	0	0
6				6	1	1	1	1	1	1	1	1	1	1	1	1	1	1	1	1	1	1	1	1	1	1	1	1
7				7	0	0	0	0	0	0	0	0	0	0	0	0	0	0	0	0	0	0	0	0	0	0	0	0
8	CRD	ADC Clock PLL Reference Divide Ratio	WCDMA: For f _{REFIN} = 13.0MHz = 5E (hex) 15.36MHz = 50 (hex) 19.2MHz = 40 (hex) 26.0MHz = 2F (hex)	0	0	0	0	0	0	0	0	0	0	0	0	0	0	0	0	0	0	0	0	0	0	0		
9	Reserved	Reserved	0 = Divide-by-1 (default) 1 = Divide-by-2	0	0	0	0	0	0	0	0	0	0	0	0	0	0	0	0	0	0	0	0	0	0	0		
10				1	1	1	1	1	1	1	1	1	1	1	1	1	1	1	1	1	1	1	1	1	1	1	1	
11				2	1	1	1	1	1	1	1	1	1	1	1	1	1	1	1	1	1	1	1	1	1	1	1	1
12				3	0	0	0	0	0	0	0	0	0	0	0	0	0	0	0	0	0	0	0	0	0	0	0	0
13				4	0	0	0	0	0	0	0	0	0	0	0	0	0	0	0	0	0	0	0	0	0	0	0	0
14				5	0	0	0	0	0	0	0	0	0	0	0	0	0	0	0	0	0	0	0	0	0	0	0	0
15				6	0	0	0	0	0	0	0	0	0	0	0	0	0	0	0	0	0	0	0	0	0	0	0	0
16				7	0	0	0	0	0	0	0	0	0	0	0	0	0	0	0	0	0	0	0	0	0	0	0	0
17				8	0	0	0	0	0	0	0	0	0	0	0	0	0	0	0	0	0	0	0	0	0	0	0	0

MAX2550

Band I, V, and VIII WCDMA Femtocell Transceiver with GSM Monitoring

Table 33. BBCLK SYN Register 15 (Address = 01111) (continued)

BIT	BIT ID	NAME	DEFINITION	BIT																		
				BAND I RX1 ONLY	DCS RX2 ONLY	BAND V RX3 ONLY	BAND VIII RX3 ONLY	BAND V RX4 ONLY	BAND VIII RX4 ONLY	BAND I RX5 ONLY	BAND I TXH ONLY	BAND V TXL ONLY	BAND VIII TXL ONLY	BAND I RX1/TXH FDD	BAND V RX3/TXL FDD	BAND VIII RX3/TXL FDD	BAND I RX IDLE	BAND I TX IDLE	AFC ONLY	REFERENCE BUFFER	SLEEP	
18	CCPI<2:0>	ADC Clock PLL Charge Pump Current	000 = 0µA, do not use 001 = 25µA 010 = 50µA (REFIN = 26MHz) 011 = 75µA (REFIN = 19.2MHz) 100 = 100µA (REFIN = 13MHz) 111 = 175µA	0	1	1	1	1	1	1	1	1	1	1	1	1	1	1	1	1	1	1
19				1	1	1	1	1	1	1	1	1	1	1	1	1	1	1	1	1	1	1
20				2	0	0	0	0	0	0	0	0	0	0	0	0	0	0	0	0	0	0
21	Reserved	Reserved	—	0	0	0	0	0	0	0	0	0	0	0	0	0	0	0	0	0	0	0
22	EN_PBYQDIV	ADC Clock PLL P/Q Rational Division Enable	ADC Clock PLL P/Q Rational Division Enable 0 = Disabled 1 = Enable	0	1	1	1	1	1	1	1	1	1	1	1	1	1	1	1	1	1	1
23	CINTB	ADC Clock PLL Integer/Fractional Mode	ADC Clock Integer/Fractional Mode 0 = Integer mode 1 = Fractional mode	1	1	1	1	1	1	1	1	1	1	1	1	1	1	1	1	1	1	1
24	Reserved	Reserved	—	0	0	0	0	0	0	0	0	0	0	0	0	0	0	0	0	0	0	0
25	Reserved	Reserved	—	1	1	1	1	1	1	1	1	1	1	1	1	1	1	1	1	1	1	1

MAX2550

Band I, V, and VIII WCDMA Femtocell Transceiver with GSM Monitoring

Table 34. BBCLK_MISC Register 16 (Address = 10000)

BIT	BIT ID	NAME	DEFINITION	BIT	BAND I RX1 ONLY	DCS RX2 ONLY	BAND V RX3 ONLY	BAND VIII RX3 ONLY	BAND V RX4 ONLY	BAND VIII RX4 ONLY	BAND I RX5 ONLY	BAND I TXH ONLY	BAND V TXL ONLY	BAND VIII TXL ONLY	BAND I RX1/TXH FDD	BAND V RX3/TXL FDD	BAND VIII RX3/TXL FDD	BAND I RX IDLE	BAND I TX IDLE	AFC ONLY	REFERENCE BUFFER	SLEEP				
0	PBYPQ_RATUP<7:0>	ADC Clock Fractional LSB Dither Up Number of Cycles LSB Is High	WCDMA: For f _{REFIN} = 13.0MHz = 3B (hex) 15.36MHz = 00 (hex) 19.2MHz = 00 (hex) 20.0MHz = 0B (hex) 26.0MHz = 3E (hex)	0	0	0	0	0	0	0	0	0	0	0	0	0	0	0	0	0	0	0				
1				0	0	0	0	0	0	0	0	0	0	0	0	0	0	0	0	0	0	0	0	0		
2				0	0	0	0	0	0	0	0	0	0	0	0	0	0	0	0	0	0	0	0	0	0	
3				0	0	0	0	0	0	0	0	0	0	0	0	0	0	0	0	0	0	0	0	0	0	0
4				0	0	0	0	0	0	0	0	0	0	0	0	0	0	0	0	0	0	0	0	0	0	0
5				0	0	0	0	0	0	0	0	0	0	0	0	0	0	0	0	0	0	0	0	0	0	0
6				0	0	0	0	0	0	0	0	0	0	0	0	0	0	0	0	0	0	0	0	0	0	0
7	0	0	0	0	0	0	0	0	0	0	0	0	0	0	0	0	0	0	0	0	0	0	0			
8	PBYPQ_RATDN<7:0>	ADC Clock Fractional LSB Dither Down Number of Cycles LSB Is Low	WCDMA: For f _{REFIN} = 13.0MHz = 06 (hex) 15.36MHz = 00 (hex) 19.2MHz = 00 (hex) 20.0MHz = 0E (hex) 26.0MHz = 03 (hex)	0	0	0	0	0	0	0	0	0	0	0	0	0	0	0	0	0	0	0	0			
9				0	0	0	0	0	0	0	0	0	0	0	0	0	0	0	0	0	0	0	0	0	0	
10				0	0	0	0	0	0	0	0	0	0	0	0	0	0	0	0	0	0	0	0	0	0	0
11				0	0	0	0	0	0	0	0	0	0	0	0	0	0	0	0	0	0	0	0	0	0	0
12				0	0	0	0	0	0	0	0	0	0	0	0	0	0	0	0	0	0	0	0	0	0	0
13				0	0	0	0	0	0	0	0	0	0	0	0	0	0	0	0	0	0	0	0	0	0	0
14				0	0	0	0	0	0	0	0	0	0	0	0	0	0	0	0	0	0	0	0	0	0	0
15	0	0	0	0	0	0	0	0	0	0	0	0	0	0	0	0	0	0	0	0	0	0	0			

MAX2550

Band I, V, and VIII WCDMA Femtocell Transceiver with GSM Monitoring

Table 34. BBCLK_MISC Register 16 (Address = 10000) (continued)

BIT	BIT ID	NAME	DEFINITION	BIT	BAND I RX1 ONLY	DCS RX2 ONLY	BAND V RX3 ONLY	BAND VIII RX3 ONLY	BAND V RX4 ONLY	BAND VIII RX4 ONLY	BAND I RX5 ONLY	BAND I TXH ONLY	BAND V TXL ONLY	BAND VIII TXL ONLY	BAND I RX1/TXH FDD	BAND V RX3/TXL FDD	BAND VIII RX3/TXL FDD	BAND I RX IDLE	BAND I TX IDLE	AFC ONLY	REFERENCE BUFFER	SLEEP				
16	Reserved	Reserved	—	0	0	0	0	0	0	0	0	0	0	0	0	0	0	0	0	0	0	0				
17				1	0	0	0	0	0	0	0	0	0	0	0	0	0	0	0	0	0	0	0	0		
18				2	1	1	1	1	1	1	1	1	1	1	1	1	1	1	1	1	1	1	1	1	1	
19				3	1	1	1	1	1	1	1	1	1	1	1	1	1	1	1	1	1	1	1	1	1	
20	CDR_DIV2_EN	CLK VCO to CDR Divide-by-2 Enable	CLK VCO to CDR Divide-by-2 Enable 0 = Disable 1 = Enable	0	0	0	0	0	0	0	0	1	1	1	1	1	1	0	0	0	0	0				
21	Reserved	Reserved	—	0	0	0	0	0	0	0	0	0	0	0	0	0	0	0	0	0	0	0				
22				1	0	0	0	0	0	0	0	0	0	0	0	0	0	0	0	0	0	0	0	0		
23				2	0	0	0	0	0	0	0	0	0	0	0	0	0	0	0	0	0	0	0	0	0	
24				3	0	0	0	0	0	0	0	0	0	0	0	0	0	0	0	0	0	0	0	0	0	0
25				4	0	0	0	0	0	0	0	0	0	0	0	0	0	0	0	0	0	0	0	0	0	0

MAX2550

Band I, V, and VIII WCDMA Femtocell Transceiver with GSM Monitoring

Table 35. BBCLK_SPARE Register 17 (Address = 10001)

BIT	BIT ID	NAME	DEFINITION	BIT	BAND I RX1 ONLY	DCS RX2 ONLY	BAND V RX3 ONLY	BAND VIII RX3 ONLY	BAND V RX4 ONLY	BAND VIII RX4 ONLY	BAND I RX5 ONLY	BAND I TXH ONLY	BAND V TXL ONLY	BAND VIII TXL ONLY	BAND I RX1/TXH FDD	BAND V RX3/TXL FDD	BAND VIII RX3/TXL FDD	BAND I RX IDLE	BAND I TX IDLE	AFC ONLY	REFERENCE BUFFER	SLEEP			
				BIT	BAND I RX1 ONLY	DCS RX2 ONLY	BAND V RX3 ONLY	BAND VIII RX3 ONLY	BAND V RX4 ONLY	BAND VIII RX4 ONLY	BAND I RX5 ONLY	BAND I TXH ONLY	BAND V TXL ONLY	BAND VIII TXL ONLY	BAND I RX1/TXH FDD	BAND V RX3/TXL FDD	BAND VIII RX3/TXL FDD	BAND I RX IDLE	BAND I TX IDLE	AFC ONLY	REFERENCE BUFFER	SLEEP			
0	Reserved	Reserved	—	0	1	1	1	1	1	1	1	1	1	1	1	1	1	1	1	1	1	1			
1				0	0	0	0	0	0	0	0	0	0	0	0	0	0	0	0	0	0	0	0	0	0
2				0	0	0	0	0	0	0	0	0	0	0	0	0	0	0	0	0	0	0	0	0	0
3				0	0	0	0	0	0	0	0	0	0	0	0	0	0	0	0	0	0	0	0	0	0
4				0	0	0	0	0	0	0	0	0	0	0	0	0	0	0	0	0	0	0	0	0	0
5				0	0	0	0	0	0	0	0	0	0	0	0	0	0	0	0	0	0	0	0	0	0
6				0	0	0	0	0	0	0	0	0	0	0	0	0	0	0	0	0	0	0	0	0	0
7				0	0	0	0	0	0	0	0	0	0	0	0	0	0	0	0	0	0	0	0	0	0
8				0	0	0	0	0	0	0	0	0	0	0	0	0	0	0	0	0	0	0	0	0	0
9				0	0	0	0	0	0	0	0	0	0	0	0	0	0	0	0	0	0	0	0	0	0
10				0	0	0	0	0	0	0	0	0	0	0	0	0	0	0	0	0	0	0	0	0	0
11				1	1	1	1	1	1	1	1	1	1	1	1	1	1	1	1	1	1	1	1	1	1
12				1	1	1	1	1	1	1	1	1	1	1	1	1	1	1	1	1	1	1	1	1	1
13				0	0	0	0	0	0	0	0	0	0	0	0	0	0	0	0	0	0	0	0	0	0
14				0	0	0	0	0	0	0	0	0	0	0	0	0	0	0	0	0	0	0	0	0	0
15				0	0	0	0	0	0	0	0	0	0	0	0	0	0	0	0	0	0	0	0	0	0
16				0	0	0	0	0	0	0	0	0	0	0	0	0	0	0	0	0	0	0	0	0	0
17				0	0	0	0	0	0	0	0	0	0	0	0	0	0	0	0	0	0	0	0	0	0
18	DIE_ID_sel	Die ID Readout Select	Affect REG17 <25:19> 0 = Read register value 1 = Read die ID	0	0	0	0	0	0	0	0	0	0	0	0	0	0	0	0	0	0	0			
19	DIE_ID<6:0>	Die ID Readout Bits at DOUT pin	DIE_ID<2:0> 001 = 1Z 010 = 2Z 011 = 3Z	0	0	0	0	0	0	0	0	0	0	0	0	0	0	0	0	0	0	0			
20				1	0	0	0	0	0	0	0	0	0	0	0	0	0	0	0	0	0	0	0	0	
21				2	0	0	0	0	0	0	0	0	0	0	0	0	0	0	0	0	0	0	0	0	0
22				3	0	0	0	0	0	0	0	0	0	0	0	0	0	0	0	0	0	0	0	0	0
23				4	0	0	0	0	0	0	0	0	0	0	0	0	0	0	0	0	0	0	0	0	0
24				5	0	0	0	0	0	0	0	0	0	0	0	0	0	0	0	0	0	0	0	0	0
25				6	0	0	0	0	0	0	0	0	0	0	0	0	0	0	0	0	0	0	0	0	0

MAX2550

Band I, V, and VIII WCDMA Femtocell Transceiver with GSM Monitoring

Table 36. TX_LPF Register 18 (Address = 10010)

BIT	BIT ID	NAME	DEFINITION	BIT	BAND I RX1 ONLY	DCS RX2 ONLY	BAND V RX3 ONLY	BAND VIII RX3 ONLY	BAND V RX4 ONLY	BAND VIII RX4 ONLY	BAND I RX5 ONLY	BAND I TXH ONLY	BAND V TXL ONLY	BAND VIII TXL ONLY	BAND I RX1/TXH FDD	BAND V RX3/TXL FDD	BAND VIII RX3/TXL FDD	BAND I RX IDLE	BAND I TX IDLE	AFC ONLY	REFERENCE BUFFER	SLEEP				
0	Reserved	Reserved	—	0	0	0	0	0	0	0	0	0	0	0	0	0	0	0	0	0	0	0				
1				0	0	0	0	0	0	0	0	0	0	0	0	0	0	0	0	0	0	0	0	0		
2				1	1	1	1	1	1	1	1	1	1	1	1	1	1	1	1	1	1	1	1	1	1	
3				1	1	1	1	1	1	1	1	1	1	1	1	1	1	1	1	1	1	1	1	1	1	1
4				0	0	0	0	0	0	0	0	0	0	0	0	0	0	0	0	0	0	0	0	0	0	0
5	TXLPFB <2:0>	TXLPF Bandwidth	000 = Do not use 001 = WCDMA 010 = Do not use 011 = Do not use 100~111 = Do not use	0	1	1	1	1	1	1	1	1	1	1	1	1	1	1	1	1	1	1	1			
6				1	0	0	0	0	0	0	0	0	0	0	0	0	0	0	0	0	0	0	0	0	0	
7				2	0	0	0	0	0	0	0	0	0	0	0	0	0	0	0	0	0	0	0	0	0	0
8	TXLPFMD <1:0>	TXLPF Operating Mode	<1:0> = 00 = Shut down <1:0> = 01 = LPF bypass <1:0> = 10 = Do not use <1:0> = 11 = Normal operation (WCDMA)	0	1	1	1	1	1	1	1	1	1	1	1	1	1	1	1	1	1	1	1			
9				1	1	1	1	1	1	1	1	1	1	1	1	1	1	1	1	1	1	1	1	1	1	
10	BBLB TXLPF Baseband Loopback		0 = Enable loopback operation 1 = Normal operation	0	1	1	1	1	1	1	1	1	1	1	1	1	1	1	1	1	1	1	1			

MAX2550

Band I, V, and VIII WCDMA Femtocell Transceiver with GSM Monitoring

Table 36. TX_LPF Register 18 (Address = 10010) (continued)

BIT	BIT ID	NAME	DEFINITION	BIT	BAND I RX1 ONLY	DCS RX2 ONLY	BAND V RX3 ONLY	BAND VIII RX3 ONLY	BAND V RX4 ONLY	BAND VIII RX4 ONLY	BAND I RX5 ONLY	BAND I TXH ONLY	BAND V TXL ONLY	BAND VIII TXL ONLY	BAND I RX1/TXH FDD	BAND V RX3/TXL FDD	BAND VIII RX3/TXL FDD	BAND I RX IDLE	BAND I TX IDLE	AFC ONLY	REFERENCE BUFFER	SLEEP			
				0	1	0	1	0	1	0	1	0	1	0	1	0	1	0	1	0	1	0	1	0	1
11	Reserved	Reserved	—	0	0	0	0	0	0	0	0	0	0	0	0	0	0	0	0	0	0	0			
12				1	1	1	1	1	1	1	1	1	1	1	1	1	1	1	1	1	1	1	1	1	
13				2	1	1	1	1	1	1	1	1	1	1	1	1	1	1	1	1	1	1	1	1	1
14				3	0	0	0	0	0	0	0	0	0	0	0	0	0	0	0	0	0	0	0	0	0
15				4	1	1	1	1	1	1	1	1	1	1	1	1	1	1	1	1	1	1	1	1	1
16				5	1	1	1	1	1	1	1	1	1	1	1	1	1	1	1	1	1	1	1	1	1
17				6	1	1	1	1	1	1	1	1	1	1	1	1	1	1	1	1	1	1	1	1	1
18				7	1	1	1	1	1	1	1	1	1	1	1	1	1	1	1	1	1	1	1	1	1
19				8	0	0	0	0	0	0	0	0	0	0	0	0	0	0	0	0	0	0	0	0	0
20				9	1	1	1	1	1	1	1	1	1	1	1	1	1	1	1	1	1	1	1	1	1
21				10	0	0	0	0	0	0	0	0	0	0	0	0	0	0	0	0	0	0	0	0	0
22				11	1	1	1	1	1	1	1	1	1	1	1	1	1	1	1	1	1	1	1	1	1
23				12	0	0	0	0	0	0	0	0	0	0	0	0	0	0	0	0	0	0	0	0	0
24				13	0	0	0	0	0	0	0	0	0	0	0	0	0	0	0	0	0	0	0	0	0
25	TXINDACF	Tx DAC Bandwidth Select	Tx DAC Bandwidth 1 = 15MHz	0	1	1	1	1	1	1	1	1	1	1	1	1	1	1	1	1	1	1			

MAX2550

Band I, V, and VIII WCDMA Femtocell Transceiver with GSM Monitoring

Table 37. TX_PAD Register 19 (Address = 10011)

BIT	BIT ID	NAME	DEFINITION	BIT	BAND I RX1 ONLY	DCS RX2 ONLY	BAND V RX3 ONLY	BAND VIII RX3 ONLY	BAND V RX4 ONLY	BAND VIII RX4 ONLY	BAND I RX5 ONLY	BAND I TXH ONLY	BAND V TXL ONLY	BAND VIII TXL ONLY	BAND I RX1/TXH FDD	BAND V RX3/TXL FDD	BAND VIII RX3/TXL FDD	BAND I RX IDLE	BAND I TX IDLE	AFC ONLY	REFERENCE BUFFER	SLEEP			
0	PAD_BAND <2:0>	PA Driver Frequency Band	<1:0> = 00 = CELL <1:0> = 01 = Do not use <1:0> = 10 = PCS <1:0> = 11 = Do not use	0	1	1	0	0	1	1	1	1	0	0	1	0	0	1	1	1	1	1			
1				1	1	0	0	1	1	1	1	1	1	0	0	1	0	0	1	1	1	1	1		
2	PAD_CTUNE <4:0>	PA Driver Center Frequency Select	CELL = 00100 PCS = 10001	0	0	0	0	0	0	0	0	0	0	0	0	0	0	0	0	0	0	0			
3				1	0	0	0	0	0	0	0	0	0	0	0	0	0	0	0	0	0	0	0		
4				2	0	0	1	1	0	0	0	0	0	0	1	1	0	1	1	0	0	0	0	0	
5				3	0	0	0	0	0	0	0	0	0	0	0	0	0	0	0	0	0	0	0	0	0
6				4	0	0	0	0	0	0	0	0	0	0	0	0	0	0	0	0	0	0	0	0	0
7	Reserved	Reserved		0	0	0	0	0	0	0	0	0	0	0	0	0	0	0	0	0	0	0			
8				1	0	0	0	0	0	0	0	0	0	0	0	0	0	0	0	0	0	0	0	0	
9				2	1	1	1	1	1	1	1	1	1	1	1	1	1	1	1	1	1	1	1	1	1
10				3	1	1	1	1	1	1	1	1	1	1	1	1	1	1	1	1	1	1	1	1	1
11				4	0	0	0	0	0	0	0	0	0	0	0	0	0	0	0	0	0	0	0	0	0
12				5	0	0	0	0	0	0	0	0	0	0	0	0	0	0	0	0	0	0	0	0	0
13				6	1	1	1	1	1	1	1	1	1	1	1	1	1	1	1	1	1	1	1	1	1
14				7	0	0	0	0	0	0	0	0	0	0	0	0	0	0	0	0	0	0	0	0	0
15				8	1	1	1	1	1	1	1	1	1	1	1	1	1	1	1	1	1	1	1	1	1
16				9	1	1	1	1	1	1	1	1	1	1	1	1	1	1	1	1	1	1	1	1	1
17				10	1	1	1	1	1	1	1	1	1	1	1	1	1	1	1	1	1	1	1	1	1
18				11	1	1	1	1	1	1	1	1	1	1	1	1	1	1	1	1	1	1	1	1	1
19				12	0	0	0	0	0	0	0	0	0	0	0	0	0	0	0	0	0	0	0	0	0
20				13	0	0	0	0	0	0	0	0	0	0	0	0	0	0	0	0	0	0	0	0	0
21				14	0	0	0	0	0	0	0	0	0	0	0	0	0	0	0	0	0	0	0	0	0
22				15	0	0	0	0	0	0	0	0	0	0	0	0	0	0	0	0	0	0	0	0	0
23				16	0	0	0	0	0	0	0	0	0	0	0	0	0	0	0	0	0	0	0	0	0
24				17	0	0	0	0	0	0	0	0	0	0	0	0	0	0	0	0	0	0	0	0	0
25	18	0	0	0	0	0	0	0	0	0	0	0	0	0	0	0	0	0	0	0	0	0			

MAX2550

Band I, V, and VIII WCDMA Femtocell Transceiver with GSM Monitoring

Table 38. TX_UPX1 Register 20 (Address = 10100)

BIT	BIT ID	NAME	DEFINITION	BIT	BAND I RX1 ONLY	DCS RX2 ONLY	BAND V RX3 ONLY	BAND VIII RX3 ONLY	BAND V RX4 ONLY	BAND VIII RX4 ONLY	BAND I RX5 ONLY	BAND I TXH ONLY	BAND V TXL ONLY	BAND VIII TXL ONLY	BAND I RX1/TXH FDD	BAND V RX3/TXL FDD	BAND VIII RX3/TXL FDD	BAND I RX IDLE	BAND I TX IDLE	AFC ONLY	REFERENCE BUFFER	SLEEP		
0	Reserved	Reserved	—	0	0	0	0	0	0	0	0	0	0	0	0	0	0	0	0	0	0	0		
1				1	1	1	1	1	1	1	1	1	1	1	1	1	1	1	1	1	1	1	1	1
2				2	1	1	1	1	1	1	1	1	1	1	1	1	1	1	1	1	1	1	1	1
3				3	0	0	0	0	0	0	0	0	0	0	0	0	0	0	0	0	0	0	0	0
4				4	1	1	1	1	1	1	1	1	1	1	1	1	1	1	1	1	1	1	1	1
5				5	1	1	1	1	1	1	1	1	1	1	1	1	1	1	1	1	1	1	1	1
6				6	0	0	0	0	0	0	0	0	0	0	0	0	0	0	0	0	0	0	0	0
7				7	1	1	1	1	1	1	1	1	1	1	1	1	1	1	1	1	1	1	1	1
8				8	1	1	1	1	1	1	1	1	1	1	1	1	1	1	1	1	1	1	1	1
9				9	0	0	0	0	0	0	0	0	0	0	0	0	0	0	0	0	0	0	0	0
10				10	0	0	0	0	0	0	0	0	0	0	0	0	0	0	0	0	0	0	0	0
11				11	0	0	0	0	0	0	0	0	0	0	0	0	0	0	0	0	0	0	0	0
12				12	1	1	1	1	1	1	1	1	1	1	1	1	1	1	1	1	1	1	1	1
13				13	1	1	1	1	1	1	1	1	1	1	1	1	1	1	1	1	1	1	1	1
14				14	1	1	1	1	1	1	1	1	1	1	1	1	1	1	1	1	1	1	1	1
15				15	1	1	1	1	1	1	1	1	1	1	1	1	1	1	1	1	1	1	1	1
16				16	1	1	1	1	1	1	1	1	1	1	1	1	1	1	1	1	1	1	1	1
17				17	0	0	0	0	0	0	0	0	0	0	0	0	0	0	0	0	0	0	0	0
18				18	0	0	0	0	0	0	0	0	0	0	0	0	0	0	0	0	0	0	0	0
19	TXLO_IQ_GAIN	TXLO IQ Phase Adjust Slope	0 = PCS bands 1 = CELL band	0	0	0	1	1	0	0	0	0	1	1	0	1	1	0	0	0	0	0		
20	Reserved	Reserved	—	0	1	1	1	1	1	1	1	1	1	1	1	1	1	1	1	1	1	1		
21				1	0	0	0	0	0	0	0	0	0	0	0	0	0	0	0	0	0	0	0	
22				2	0	0	0	0	0	0	0	0	0	0	0	0	0	0	0	0	0	0	0	0
23				3	0	0	0	0	0	0	0	0	0	0	0	0	0	0	0	0	0	0	0	0
24	BIAS_EN	Master Bias Enable	0 = Disable 1 = Enable	0	1	1	1	1	1	1	1	1	1	1	1	1	1	1	1	0	0	0		
25	Reserved	Reserved	—	0	0	0	0	0	0	0	0	0	0	0	0	0	0	0	0	0	0	0		

MAX2550

Band I, V, and VIII WCDMA Femtocell Transceiver with GSM Monitoring

Table 39. TX_UPX2 Register 21 (Address = 10101)

BIT	BIT ID	NAME	DEFINITION	BIT	BAND I RX1 ONLY	DCS RX2 ONLY	BAND V RX3 ONLY	BAND VIII RX3 ONLY	BAND V RX4 ONLY	BAND VIII RX4 ONLY	BAND I RX5 ONLY	BAND I TXH ONLY	BAND V TXL ONLY	BAND VIII TXL ONLY	BAND I RX1/TXH FDD	BAND V RX3/TXL FDD	BAND VIII RX3/TXL FDD	BAND I RX IDLE	BAND I TX IDLE	AFC ONLY	REFERENCE BUFFER	SLEEP		
0	Reserved	Reserved	—	0	0	0	0	0	0	0	0	0	0	0	0	0	0	0	0	0	0			
1	Reserved	Reserved		0	0	0	0	0	0	0	0	0	0	0	0	0	0	0	0	0	0	0		
2	UCX_CSW <3:0>	UCX Tank Frequency Adjust	0000 = PCS 1101 = CELL	0	0	0	1	1	1	1	0	0	1	1	0	1	1	0	0	0	0	0		
3				1	0	0	0	1	0	1	0	0	0	1	0	0	0	1	0	0	0	0	0	
4				2	0	0	1	0	1	0	0	0	0	1	0	0	1	0	0	0	0	0	0	0
5				3	0	0	1	1	1	1	1	0	0	1	1	0	1	1	0	0	0	0	0	0
6	Reserved	Reserved	—	0	0	0	0	0	0	0	0	0	0	0	0	0	0	0	0	0	0	0		
7				1	0	0	0	0	0	0	0	0	0	0	0	0	0	0	0	0	0	0	0	
8				2	0	0	0	0	0	0	0	0	0	0	0	0	0	0	0	0	0	0	0	0
9				3	0	0	0	0	0	0	0	0	0	0	0	0	0	0	0	0	0	0	0	0
10				4	0	0	0	0	0	0	0	0	0	0	0	0	0	0	0	0	0	0	0	0
11				5	0	0	0	0	0	0	0	0	0	0	0	0	0	0	0	0	0	0	0	0
12				6	1	1	1	1	1	1	1	1	1	1	1	1	1	1	1	1	1	1	1	1
13				7	0	0	0	0	0	0	0	0	0	0	0	0	0	0	0	0	0	0	0	0
14				8	0	0	0	0	0	0	0	0	0	0	0	0	0	0	0	0	0	0	0	0
15				9	1	1	1	1	1	1	1	1	1	1	1	1	1	1	1	1	1	1	1	1
16				10	0	0	0	0	0	0	0	0	0	0	0	0	0	0	0	0	0	0	0	0
17				11	0	0	0	0	0	0	0	0	0	0	0	0	0	0	0	0	0	0	0	0
18				12	1	1	1	1	1	1	1	1	1	1	1	1	1	1	1	1	1	1	1	1
19				13	0	0	0	0	0	0	0	0	0	0	0	0	0	0	0	0	0	0	0	0
20				14	1	1	1	1	1	1	1	1	1	1	1	1	1	1	1	1	1	1	1	1
21				15	0	0	0	0	0	0	0	0	0	0	0	0	0	0	0	0	0	0	0	0
22				16	0	0	0	0	0	0	0	0	0	0	0	0	0	0	0	0	0	0	0	0
23				17	0	0	0	0	0	0	0	0	0	0	0	0	0	0	0	0	0	0	0	0
24				18	0	0	0	0	0	0	0	0	0	0	0	0	0	0	0	0	0	0	0	0
25				19	1	1	1	1	1	1	1	1	1	1	1	1	1	1	1	1	1	1	1	1

MAX2550

Band I, V, and VIII WCDMA Femtocell Transceiver with GSM Monitoring

Table 40. TX_UPX3 Register 22 (Address = 10110)

BIT	BIT ID	NAME	DEFINITION	BIT	BAND I RX1 ONLY	DCS RX2 ONLY	BAND V RX3 ONLY	BAND VIII RX3 ONLY	BAND V RX4 ONLY	BAND VIII RX4 ONLY	BAND I RX5 ONLY	BAND I TXH ONLY	BAND V TXL ONLY	BAND VIII TXL ONLY	BAND I RX1/TXH FDD	BAND V RX3/TXL FDD	BAND VIII RX3/TXL FDD	BAND I RX IDLE	BAND I TX IDLE	AFC ONLY	REFERENCE BUFFER	SLEEP					
0	Reserved	Reserved	—	0	1	1	1	1	1	1	1	1	1	1	1	1	1	1	1	1	1	1					
1				1	1	1	1	1	1	1	1	1	1	1	1	1	1	1	1	1	1	1	1	1			
2				1	1	1	1	1	1	1	1	1	1	1	1	1	1	1	1	1	1	1	1	1	1		
3				1	1	1	1	1	1	1	1	1	1	1	1	1	1	1	1	1	1	1	1	1	1	1	
4				0	0	0	0	0	0	0	0	0	0	0	0	0	0	0	0	0	0	0	0	0	0	0	0
5				1	1	1	1	1	1	1	1	1	1	1	1	1	1	1	1	1	1	1	1	1	1	1	1
6				1	1	1	1	1	1	1	1	1	1	1	1	1	1	1	1	1	1	1	1	1	1	1	1
7				1	1	1	1	1	1	1	1	1	1	1	1	1	1	1	1	1	1	1	1	1	1	1	1
8				1	1	1	1	1	1	1	1	1	1	1	1	1	1	1	1	1	1	1	1	1	1	1	1
9				0	0	0	0	0	0	0	0	0	0	0	0	0	0	0	0	0	0	0	0	0	0	0	0
10				0	0	0	0	0	0	0	0	0	0	0	0	0	0	0	0	0	0	0	0	0	0	0	0
11				1	1	1	1	1	1	1	1	1	1	1	1	1	1	1	1	1	1	1	1	1	1	1	1
12				0	0	0	0	0	0	0	0	0	0	0	0	0	0	0	0	0	0	0	0	0	0	0	0
13				0	0	0	0	0	0	0	0	0	0	0	0	0	0	0	0	0	0	0	0	0	0	0	0
14				0	0	0	0	0	0	0	0	0	0	0	0	0	0	0	0	0	0	0	0	0	0	0	0
15				1	1	1	1	1	1	1	1	1	1	1	1	1	1	1	1	1	1	1	1	1	1	1	1
16				0	0	0	0	0	0	0	0	0	0	0	0	0	0	0	0	0	0	0	0	0	0	0	0
17				1	1	0	0	1	1	1	1	1	1	0	0	1	0	0	1	1	1	1	1	1	1	1	1
18				0	0	0	0	0	0	0	0	0	0	0	0	0	0	0	0	0	0	0	0	0	0	0	0
19				1	1	1	1	1	1	1	1	1	1	1	1	1	1	1	1	1	1	1	1	1	1	1	1
20				0	0	0	0	0	0	0	0	0	0	0	0	0	0	0	0	0	0	0	0	0	0	0	0
21				0	0	0	0	0	0	0	0	0	0	0	0	0	0	0	0	0	0	0	0	0	0	0	0
22	T_UCX_BAND_SEL <1:0>	Upconverter Band Select	<1:0> = 00 = Do not use <1:0> = 01 = WCDMA <1:0> = 10 = Do not use <1:0> = 11 = PCS band	0	1	1	1	1	1	1	1	1	1	1	1	1	1	1	1	1	1	1	1	1			
23				1	1	0	0	1	1	1	1	0	0	1	0	0	1	1	1	1	1	1	1	1	1		
24	UCX_V2L_MODE_F <1:0>	Upconverter V2L Bandwidth	<1:0> = 00 = Do not use <1:0> = 01 = WCDMA <1:0> = 10 = Do not use <1:0> = 11 = Do not use	0	1	1	1	1	1	1	1	1	1	1	1	1	1	1	1	1	1	1	1	1			
25				1	0	0	0	0	0	0	0	0	0	0	0	0	0	0	0	0	0	0	0	0	0		

MAX2550

Band I, V, and VIII WCDMA Femtocell Transceiver with GSM Monitoring

Table 41. TX_GAIN1 Register 23 (Address = 10111)

BIT	BIT ID	NAME	DEFINITION	BIT	BAND1 RX1 ONLY	DCS RX2 ONLY	BAND V RX3 ONLY	BAND VIII RX3 ONLY	BAND V RX4 ONLY	BAND VIII RX4 ONLY	BAND I RX5 ONLY	BAND I TXH ONLY	BAND V TXL ONLY	BAND VIII TXL ONLY	BAND I RX1/TXH FDD	BAND V RX3/TXL FDD	BAND VIII RX3/TXL FDD	BAND I RX IDLE	BAND I TX IDLE	AFC ONLY	REFERENCE BUFFER	SLEEP			
0	TX_GAIN <:9:0>	Tx Gain	000 (hex) = Minimum gain 3FF (hex) = Maximum gain	0	1	1	1	1	1	1	1	1	1	1	1	1	1	1	1	1	1	1			
1				1	1	1	1	1	1	1	1	1	1	1	1	1	1	1	1	1	1	1	1	1	
2				1	1	1	1	1	1	1	1	1	1	1	1	1	1	1	1	1	1	1	1	1	1
3				1	1	1	1	1	1	1	1	1	1	1	1	1	1	1	1	1	1	1	1	1	1
4				1	1	1	1	1	1	1	1	1	1	1	1	1	1	1	1	1	1	1	1	1	1
5				1	1	1	1	1	1	1	1	1	1	1	1	1	1	1	1	1	1	1	1	1	1
6				1	1	1	1	1	1	1	1	1	1	1	1	1	1	1	1	1	1	1	1	1	1
7				1	1	1	1	1	1	1	1	1	1	1	1	1	1	1	1	1	1	1	1	1	1
8				1	1	1	1	1	1	1	1	1	1	1	1	1	1	1	1	1	1	1	1	1	1
9				1	1	1	1	1	1	1	1	1	1	1	1	1	1	1	1	1	1	1	1	1	1
10	Reserved	Reserved	—	0	0	0	0	0	0	0	0	0	0	0	0	0	0	0	0	0	0	0			
11				1	1	1	1	1	1	1	1	1	1	1	1	1	1	1	1	1	1	1	1	1	
12				0	0	0	0	0	0	0	0	0	0	0	0	0	0	0	0	0	0	0	0	0	
13				0	0	0	0	0	0	0	0	0	0	0	0	0	0	0	0	0	0	0	0	0	
14				1	1	1	1	1	1	1	1	1	1	1	1	1	1	1	1	1	1	1	1	1	1
15				1	1	1	1	1	1	1	1	1	1	1	1	1	1	1	1	1	1	1	1	1	1
16				0	0	0	0	0	0	0	0	0	0	0	0	0	0	0	0	0	0	0	0	0	0
17				0	0	0	0	0	0	0	0	0	0	0	0	0	0	0	0	0	0	0	0	0	0
18				0	0	0	0	0	0	0	0	0	0	0	0	0	0	0	0	0	0	0	0	0	0
19				0	0	0	0	0	0	0	0	0	0	0	0	0	0	0	0	0	0	0	0	0	0
20				0	0	0	0	0	0	0	0	0	0	0	0	0	0	0	0	0	0	0	0	0	0
21				1	1	1	1	1	1	1	1	1	1	1	1	1	1	1	1	1	1	1	1	1	1
22				0	0	0	0	0	0	0	0	0	0	0	0	0	0	0	0	0	0	0	0	0	0
23				0	0	0	0	0	0	0	0	0	0	0	0	0	0	0	0	0	0	0	0	0	0
24	GPO1<1:0>	GPO1 Output Select	<1:0> = 00 = High-Z <1:0> = 01 = High-Z <1:0> = 10 = Low-Z low <1:0> = 11 = Low-Z high	0	1	1	1	1	1	1	1	1	1	1	1	1	1	1	1	1	1	1			
25				1	0	0	0	0	0	0	0	0	0	0	0	0	0	0	0	0	0	0	0		

MAX2550

Band I, V, and VIII WCDMA Femtocell Transceiver with GSM Monitoring

Table 42. TX_GAIN2 Register 24 (Address = 11000)

BIT	BIT ID	NAME	DEFINITION	BIT	BAND I RX1 ONLY	DCS RX2 ONLY	BAND V RX3 ONLY	BAND VIII RX3 ONLY	BAND V RX4 ONLY	BAND VIII RX4 ONLY	BAND I RX5 ONLY	BAND I TXH ONLY	BAND V TXL ONLY	BAND VIII TXL ONLY	BAND I RX1/TXH FDD	BAND V RX3/TXL FDD	BAND VIII RX3/TXL FDD	BAND I RX IDLE	BAND I TX IDLE	AFC ONLY	REFERENCE BUFFER	SLEEP				
0	Reserved	Reserved	—	0	0	0	0	0	0	0	0	0	0	0	0	0	0	0	0	0	0	0				
1				1	1	1	1	1	1	1	1	1	1	1	1	1	1	1	1	1	1	1	1	1		
2				2	0	0	0	0	0	0	0	0	0	0	0	0	0	0	0	0	0	0	0	0	0	
3				3	0	0	0	0	0	0	0	0	0	0	0	0	0	0	0	0	0	0	0	0	0	0
4				4	0	0	0	0	0	0	0	0	0	0	0	0	0	0	0	0	0	0	0	0	0	0
5				5	0	0	0	0	0	0	0	0	0	0	0	0	0	0	0	0	0	0	0	0	0	0
6	TXINDACI <5:0>	TXBB DAC Bias Current	TXBB DAC Bias Current 010100 = WCDMA	0	0	0	0	0	0	0	0	0	0	0	0	0	0	0	0	0	0	0	0			
7				1	0	0	0	0	0	0	0	0	0	0	0	0	0	0	0	0	0	0	0	0	0	
8				2	1	1	1	1	1	1	1	1	1	1	1	1	1	1	1	1	1	1	1	1	1	1
9				3	0	0	0	0	0	0	0	0	0	0	0	0	0	0	0	0	0	0	0	0	0	0
10				4	1	1	1	1	1	1	1	1	1	1	1	1	1	1	1	1	1	1	1	1	1	1
11				5	0	0	0	0	0	0	0	0	0	0	0	0	0	0	0	0	0	0	0	0	0	0
12	TXINDACZI	TXBB Differential Input Impedance	0 = 220Ω 1 = 100Ω	0	1	1	1	1	1	1	1	1	1	1	1	1	1	1	1	1	1	1	1			

MAX2550

Band I, V, and VIII WCDMA Femtocell Transceiver with GSM Monitoring

Table 42. TX_GAIN2 Register 24 (Address = 11000) (continued)

BIT	BIT ID	NAME	DEFINITION	BIT	BAND I RX1 ONLY	DCS RX2 ONLY	BAND V RX3 ONLY	BAND VIII RX3 ONLY	BAND V RX4 ONLY	BAND VIII RX4 ONLY	BAND I RX5 ONLY	BAND I TXH ONLY	BAND V TXL ONLY	BAND VIII TXL ONLY	BAND I RX1/TXH FDD	BAND V RX3/TXL FDD	BAND VIII RX3/TXL FDD	BAND I RX IDLE	BAND I TX IDLE	AFC ONLY	REFERENCE BUFFER	SLEEP				
13	Reserved	Reserved	—	0	0	0	0	0	0	0	0	0	0	0	0	0	0	0	0	0	0	0				
14				1	0	0	0	0	0	0	0	0	0	0	0	0	0	0	0	0	0	0	0	0		
15				2	0	0	0	0	0	0	0	0	0	0	0	0	0	0	0	0	0	0	0	0	0	
16				3	0	0	0	0	0	0	0	0	0	0	0	0	0	0	0	0	0	0	0	0	0	0
17				4	0	0	0	0	0	0	0	0	0	0	0	0	0	0	0	0	0	0	0	0	0	0
18	CDR_EN	CDR Enable	CDR Enable 0 = Disable 1 = Enable	0	0	0	0	0	0	0	0	1	1	1	1	1	1	0	0	0	0	0	0			
19	Reserved	Reserved	—	0	1	1	1	1	1	1	1	1	1	1	1	1	1	1	1	1	1	1	1			
20				1	1	1	1	1	1	1	1	1	1	1	1	1	1	1	1	1	1	1	1	1		
21	TXBB_LVDS_DDR3	TXBB Input LVDS/DDR3 Select	TXBB Input LVDS/DDR3 Select 0 = LVDS 1 = DDR3	0	0	0	0	0	0	0	0	0	0	0	0	0	0	0	0	0	0	0	0			
22	Reserved	Reserved	—	0	0	0	0	0	0	0	0	0	0	0	0	0	0	0	0	0	0	0	0			
23				1	0	0	0	0	0	0	0	0	0	0	0	0	0	0	0	0	0	0	0	0	0	
24				2	0	0	0	0	0	0	0	0	0	0	0	0	0	0	0	0	0	0	0	0	0	0
25				3	0	0	0	0	0	0	0	0	0	0	0	0	0	0	0	0	0	0	0	0	0	0

MAX2550

Band I, V, and VIII WCDMA Femtocell Transceiver with GSM Monitoring

Table 43. Reserved Register 25 (Address = 11001)

BIT	BIT ID	NAME	DEFINITION	BIT	BAND I RX1 ONLY	DCS RX2 ONLY	BAND V RX3 ONLY	BAND VIII RX3 ONLY	BAND V RX4 ONLY	BAND VIII RX4 ONLY	BAND I RX5 ONLY	BAND I TXH ONLY	BAND V TXL ONLY	BAND VIII TXL ONLY	BAND I RX1/TXH FDD	BAND V RX3/TXL FDD	BAND VIII RX3/TXL FDD	BAND I RX IDLE	BAND I TX IDLE	AFC ONLY	REFERENCE BUFFER	SLEEP			
0	Reserved	Reserved	—	0	0	0	0	0	0	0	0	0	0	0	0	0	0	0	0	0	0	0			
1				0	0	0	0	0	0	0	0	0	0	0	0	0	0	0	0	0	0	0	0	0	
2				0	0	0	0	0	0	0	0	0	0	0	0	0	0	0	0	0	0	0	0	0	0
3				0	0	0	0	0	0	0	0	0	0	0	0	0	0	0	0	0	0	0	0	0	0
4				0	0	0	0	0	0	0	0	0	0	0	0	0	0	0	0	0	0	0	0	0	0
5				0	0	0	0	0	0	0	0	0	0	0	0	0	0	0	0	0	0	0	0	0	0
6				0	0	0	0	0	0	0	0	0	0	0	0	0	0	0	0	0	0	0	0	0	0
7				0	0	0	0	0	0	0	0	0	0	0	0	0	0	0	0	0	0	0	0	0	0
8				0	0	0	0	0	0	0	0	0	0	0	0	0	0	0	0	0	0	0	0	0	0
9				0	0	0	0	0	0	0	0	0	0	0	0	0	0	0	0	0	0	0	0	0	0
10				0	0	0	0	0	0	0	0	0	0	0	0	0	0	0	0	0	0	0	0	0	0
11				0	0	0	0	0	0	0	0	0	0	0	0	0	0	0	0	0	0	0	0	0	0
12				0	0	0	0	0	0	0	0	0	0	0	0	0	0	0	0	0	0	0	0	0	0
13				0	0	0	0	0	0	0	0	0	0	0	0	0	0	0	0	0	0	0	0	0	0
14				0	0	0	0	0	0	0	0	0	0	0	0	0	0	0	0	0	0	0	0	0	0
15				0	0	0	0	0	0	0	0	0	0	0	0	0	0	0	0	0	0	0	0	0	0
16				0	0	0	0	0	0	0	0	0	0	0	0	0	0	0	0	0	0	0	0	0	0
17				0	0	0	0	0	0	0	0	0	0	0	0	0	0	0	0	0	0	0	0	0	0
18				0	0	0	0	0	0	0	0	0	0	0	0	0	0	0	0	0	0	0	0	0	0
19				0	0	0	0	0	0	0	0	0	0	0	0	0	0	0	0	0	0	0	0	0	0
20				0	0	0	0	0	0	0	0	0	0	0	0	0	0	0	0	0	0	0	0	0	0
21				0	0	0	0	0	0	0	0	0	0	0	0	0	0	0	0	0	0	0	0	0	0
22				0	0	0	0	0	0	0	0	0	0	0	0	0	0	0	0	0	0	0	0	0	0
23				0	0	0	0	0	0	0	0	0	0	0	0	0	0	0	0	0	0	0	0	0	0
24				0	0	0	0	0	0	0	0	0	0	0	0	0	0	0	0	0	0	0	0	0	0
25				0	0	0	0	0	0	0	0	0	0	0	0	0	0	0	0	0	0	0	0	0	0

MAX2550

Band I, V, and VIII WCDMA Femtocell Transceiver with GSM Monitoring

Table 44. Reserved Register 26 (Address = 11010)

BIT	BIT ID	NAME	DEFINITION	BIT	BAND I RX1 ONLY	DCS RX2 ONLY	BAND V RX3 ONLY	BAND VIII RX3 ONLY	BAND V RX4 ONLY	BAND VIII RX4 ONLY	BAND I RX5 ONLY	BAND I TXH ONLY	BAND V TXL ONLY	BAND VIII TXL ONLY	BAND I RX1/TXH FDD	BAND V RX3/TXL FDD	BAND VIII RX3/TXL FDD	BAND I RX IDLE	BAND I TX IDLE	AFC ONLY	REFERENCE BUFFER	SLEEP			
0	Reserved	Reserved	1	0	1	1	1	1	1	1	1	1	1	1	1	1	1	1	1	1	1	1			
1				1	1	1	1	1	1	1	1	1	1	1	1	1	1	1	1	1	1	1	1	1	
2				2	1	1	1	1	1	1	1	1	1	1	1	1	1	1	1	1	1	1	1	1	
3				3	1	1	1	1	1	1	1	1	1	1	1	1	1	1	1	1	1	1	1	1	
4				4	0	0	0	0	0	0	0	0	0	0	0	0	0	0	0	0	0	0	0	0	0
5				5	0	0	0	0	0	0	0	0	0	0	0	0	0	0	0	0	0	0	0	0	0
6				6	1	1	1	1	1	1	1	1	1	1	1	1	1	1	1	1	1	1	1	1	1
7				7	1	1	1	1	1	1	1	1	1	1	1	1	1	1	1	1	1	1	1	1	1
8				8	0	0	0	0	0	0	0	0	0	0	0	0	0	0	0	0	0	0	0	0	0
9				9	1	1	1	1	1	1	1	1	1	1	1	1	1	1	1	1	1	1	1	1	1
10				10	0	0	0	0	0	0	0	0	0	0	0	0	0	0	0	0	0	0	0	0	0
11				11	0	0	0	0	0	0	0	0	0	0	0	0	0	0	0	0	0	0	0	0	0
12				12	0	0	0	0	0	0	0	0	0	0	0	0	0	0	0	0	0	0	0	0	0
13				13	0	0	0	0	0	0	0	0	0	0	0	0	0	0	0	0	0	0	0	0	0
14				14	1	1	1	1	1	1	1	1	1	1	1	1	1	1	1	1	1	1	1	1	1
15				15	1	1	1	1	1	1	1	1	1	1	1	1	1	1	1	1	1	1	1	1	1
16				16	0	0	0	0	0	0	0	0	0	0	0	0	0	0	0	0	0	0	0	0	0
17				17	0	0	0	0	0	0	0	0	0	0	0	0	0	0	0	0	0	0	0	0	0
18				18	0	0	0	0	0	0	0	0	0	0	0	0	0	0	0	0	0	0	0	0	0
19				19	1	1	1	1	1	1	1	1	1	1	1	1	1	1	1	1	1	1	1	1	1
20				20	1	1	1	1	1	1	1	1	1	1	1	1	1	1	1	1	1	1	1	1	1
21				21	0	0	0	0	0	0	0	0	0	0	0	0	0	0	0	0	0	0	0	0	0
22				22	0	0	0	0	0	0	0	0	0	0	0	0	0	0	0	0	0	0	0	0	0
23				23	0	0	0	0	0	0	0	0	0	0	0	0	0	0	0	0	0	0	0	0	0
24				24	0	0	0	0	0	0	0	0	0	0	0	0	0	0	0	0	0	0	0	0	0
25				25	0	0	0	0	0	0	0	0	0	0	0	0	0	0	0	0	0	0	0	0	0

MAX2550

Band I, V, and VIII WCDMA Femtocell Transceiver with GSM Monitoring

Table 45. TXLO_FRAC Register 27 (Address = 11011)

BIT	BIT ID	NAME	DEFINITION	BIT	BAND I RX1 ONLY	DCS RX2 ONLY	BAND V RX3 ONLY	BAND VIII RX3 ONLY	BAND V RX4 ONLY	BAND VIII RX4 ONLY	BAND I RX5 ONLY	BAND I TXH ONLY	BAND V TXL ONLY	BAND VIII TXL ONLY	BAND I RX1/TXH FDD	BAND V RX3/TXL FDD	BAND VIII RX3/TXL FDD	BAND I RX IDLE	BAND I TX IDLE	AFC ONLY	REFERENCE BUFFER	SLEEP		
0	TFRAC <19:0>	Tx RF PLL Fractional Divide Ratio	AAAAB (hex) = CELL band 36AAB (hex) = PCS band	0	1	1	0	0	0	0	1	1	0	0	1	0	0	1	1	1	1	1		
1				0	0	1	1	1	1	1	0	0	1	1	1	0	1	1	0	0	0	0	0	
2				1	1	0	0	0	0	0	0	0	1	1	0	0	1	0	0	1	1	1	1	1
3				0	0	1	1	1	1	1	1	0	0	0	1	1	0	1	1	0	0	0	0	0
4				1	1	0	0	0	0	0	0	0	1	1	0	0	1	0	0	1	1	1	1	1
5				0	0	1	1	1	1	1	1	1	0	0	1	1	0	1	1	0	0	0	0	0
6				1	1	0	0	0	0	0	0	0	1	1	0	0	1	0	0	1	1	1	1	1
7				0	0	1	1	1	1	1	1	1	0	0	1	1	0	1	1	0	0	0	0	0
8				1	1	0	0	0	0	0	0	0	1	1	0	0	1	0	0	1	1	1	1	1
9				0	0	1	1	1	1	1	1	1	0	0	1	1	0	1	1	0	0	0	0	0
10				1	1	0	0	0	0	0	0	0	1	1	0	0	1	0	0	1	1	1	1	1
11				0	0	1	1	1	1	1	1	1	0	0	1	1	0	1	1	0	0	0	0	0
12				1	1	0	0	0	0	0	0	0	1	1	0	0	1	0	0	1	1	1	1	1
13				0	0	1	1	1	1	1	1	1	0	0	1	1	0	1	1	0	0	0	0	0
14				1	1	0	0	0	0	0	0	0	1	1	0	0	1	0	0	1	1	1	1	1
15				0	0	1	1	1	1	1	1	1	0	0	1	1	0	1	1	0	0	0	0	0
16				1	1	0	0	0	0	0	0	0	1	1	0	0	1	0	0	1	1	1	1	1
17				1	1	1	1	1	1	1	1	1	1	1	1	1	1	1	1	1	1	1	1	1
18				1	1	0	1	0	1	1	1	1	1	1	0	1	1	0	1	1	1	1	1	1
19				0	0	1	1	1	1	1	1	1	0	0	1	1	0	1	1	0	0	0	0	0
20	Reserved	Reserved	—	0	1	1	1	1	1	1	1	1	1	1	1	1	1	1	1	1	1	1		
21				1	0	0	0	0	0	0	0	0	0	0	0	0	0	0	0	0	0	0	0	
22				3	0	0	0	0	0	0	0	0	0	0	0	0	0	0	0	0	0	0	0	
23				4	0	0	0	0	0	0	0	0	0	0	0	0	0	0	0	0	0	0	0	
24				5	0	0	0	0	0	0	0	0	0	0	0	0	0	0	0	0	0	0	0	
25				6	1	1	1	1	1	1	1	1	1	1	1	1	1	1	1	1	1	1	1	1

MAX2550

Band I, V, and VIII WCDMA Femtocell Transceiver with GSM Monitoring

Table 46. TXLO_SYN Register 28 (Address = 11100) (continued)

BIT	BIT ID	NAME	DEFINITION	BIT	BAND I RX1 ONLY	DCS RX2 ONLY	BAND V RX3 ONLY	BAND VIII RX3 ONLY	BAND V RX4 ONLY	BAND VIII RX4 ONLY	BAND I RX5 ONLY	BAND I TXH ONLY	BAND V TXL ONLY	BAND VIII TXL ONLY	BAND I RX1/TXH FDD	BAND V RX3/TXL FDD	BAND VIII RX3/TXL FDD	BAND I RX IDLE	BAND I TX IDLE	AFC ONLY	REFERENCE BUFFER	SLEEP			
14	TVCO_SEL <1:0>	Tx RF VCO Selection	<1:0> = 00 = Disable <1:0> = 01 = ROL <1:0> = 10 = ROH <1:0> = 11 = Not used	0	1	1	1	0	1	1	1	1	1	0	1	1	0	1	1	1	1	1			
15				1	1	1	0	1	1	1	1	1	1	0	1	1	0	1	1	1	1	1	1		
16	Reserved	Reserved	—	0	0	0	0	1	0	0	0	0	0	1	0	0	1	0	0	0	0	0			
17				1	0	0	0	0	0	0	0	0	0	0	0	0	0	0	0	0	0	0	0	0	
18	TCPI<2:0>	Tx RF PLL Charge Pump Current	000 = 0µA, 001 = 200µA ... 100 = 800µA ... 110 = 1200µA	0	0	0	0	0	0	0	0	0	0	0	0	0	0	0	0	0	0	0			
19				1	0	0	0	0	0	0	0	0	0	0	0	0	0	0	0	0	0	0	0	0	
20				2	1	1	1	1	1	1	1	1	1	1	1	1	1	1	1	1	1	1	1	1	1
21	Reserved	Reserved	—	0	1	1	1	1	1	1	1	1	1	1	1	1	1	1	1	1	1	1	1		
22				1	0	0	0	0	0	0	0	0	0	0	0	0	0	0	0	0	0	0	0	0	
23				2	1	1	1	1	1	1	1	1	1	1	1	1	1	1	1	1	1	1	1	1	1
24				3	1	1	1	1	1	1	1	1	1	1	1	1	1	1	1	1	1	1	1	1	1
25				4	0	0	0	0	0	0	0	0	0	0	0	0	0	0	0	0	0	0	0	0	0

MAX2550

Band I, V, and VIII WCDMA Femtocell Transceiver with GSM Monitoring

Table 47. TXLO_REF Register 29 (Address = 11101)

BIT	BIT ID	NAME	DEFINITION	BIT	BAND I RX1 ONLY	DCS RX2 ONLY	BAND V RX3 ONLY	BAND VIII RX3 ONLY	BAND V RX4 ONLY	BAND VIII RX4 ONLY	BAND I RX5 ONLY	BAND I TXH ONLY	BAND V TXL ONLY	BAND VIII TXL ONLY	BAND I RX1/TXH FDD	BAND V RX3/TXL FDD	BAND VIII RX3/TXL FDD	BAND I RX IDLE	BAND I TX IDLE	AFC ONLY	REFERENCE BUFFER	SLEEP						
0	Reserved	Reserved	—	0	1	1	1	1	1	1	1	1	1	1	1	1	1	1	1	1	1	1						
1				1	1	1	1	1	1	1	1	1	1	1	1	1	1	1	1	1	1	1	1	1				
2				1	1	1	1	1	1	1	1	1	1	1	1	1	1	1	1	1	1	1	1	1	1			
3				0	0	0	0	0	0	0	0	0	0	0	0	0	0	0	0	0	0	0	0	0	0	0		
4				0	0	0	0	0	0	0	0	0	0	0	0	0	0	0	0	0	0	0	0	0	0	0	0	
5				0	0	0	0	0	0	0	0	0	0	0	0	0	0	0	0	0	0	0	0	0	0	0	0	
6				0	0	0	0	0	0	0	0	0	0	0	0	0	0	0	0	0	0	0	0	0	0	0	0	
7				0	0	0	0	0	0	0	0	0	0	0	0	0	0	0	0	0	0	0	0	0	0	0	0	0
8				1	1	1	1	1	1	1	1	1	1	1	1	1	1	1	1	1	1	1	1	1	1	1	1	1
9				1	1	1	1	1	1	1	1	1	1	1	1	1	1	1	1	1	1	1	1	1	1	1	1	1
10				0	0	0	0	0	0	0	0	0	0	0	0	0	0	0	0	0	0	0	0	0	0	0	0	0
11				0	0	0	0	0	0	0	0	0	0	0	0	0	0	0	0	0	0	0	0	0	0	0	0	0
12	REFIN_ENOUT1	Reference Rx PLL Output Enable	Reference for Rx PLL Enable 0 = Disable 1 = Enable	0	1	1	1	1	1	1	1	1	1	1	1	1	1	1	1	0	0	0	0	0	0			
13	REFIN_ENOUT2	Reference Tx PLL Output Enable	Reference for Tx PLL Enable 0 = Disable 1 = Enable	0	1	1	1	1	1	1	1	1	1	1	1	1	1	1	1	0	0	0	0	0	0			

MAX2550

Band I, V, and VIII WCDMA Femtocell Transceiver with GSM Monitoring

Table 47. TXLO_REF Register 29 (Address = 11101) (continued)

BIT	BIT ID	NAME	DEFINITION	BIT	BAND I RX1 ONLY	DCS RX2 ONLY	BAND V RX3 ONLY	BAND VIII RX3 ONLY	BAND V RX4 ONLY	BAND VIII RX4 ONLY	BAND I RX5 ONLY	BAND I TXH ONLY	BAND V TXL ONLY	BAND VIII TXL ONLY	BAND I RX1/TXH FDD	BAND V RX3/TXL FDD	BAND VIII RX3/TXL FDD	BAND I RX IDLE	BAND I TX IDLE	AFC ONLY	REFERENCE BUFFER	SLEEP			
14	REFIN_ENOUT3	REFOUT Enable	REFOUT Enable 0 = Disable 1 = Enable	0	1	1	1	1	1	1	1	1	1	1	1	1	1	1	1	0	1	0			
15	Reserved	Reserved	—	0	0	0	0	0	0	0	0	0	0	0	0	0	0	0	0	0	0	0			
16				1	0	0	0	0	0	0	0	0	0	0	0	0	0	0	0	0	0	0	0		
17				2	0	0	0	0	0	0	0	0	0	0	0	0	0	0	0	0	0	0	0	0	
18				3	1	1	1	1	1	1	1	1	1	1	1	1	1	1	1	1	1	1	1	1	1
19				4	0	0	0	0	0	0	0	0	0	0	0	0	0	0	0	0	0	0	0	0	0
20				5	1	1	1	1	1	1	1	1	1	1	1	1	1	1	1	1	1	1	1	1	1
21	REFOUT_DRV<1:0>	REFOUT Buffer Drive Strength	REFOUT Drive Strength 00 = 1x 01 = 2x 10 = 3x 11 = 4x	0	1	1	1	1	1	1	1	1	1	1	1	1	1	1	1	1	1	1			
22	REFOUT Output Driver Select	REFOUT Output Driver Select		1	1	1	1	1	1	1	1	1	1	1	1	1	1	1	1	1	1	1	1		
23	REFOUT_LV_CMOS_SEL	REFOUT Output Driver Select	0 = CMOS 1 = Low voltage	0	0	0	0	0	0	0	0	0	0	0	0	0	0	0	0	0	0	0			
24	Reserved	Reserved	—	0	0	0	0	0	0	0	0	0	0	0	0	0	0	0	0	0	0	0			
25				1	0	0	0	0	0	0	0	0	0	0	0	0	0	0	0	0	0	0	0	0	

MAX2550

Band I, V, and VIII WCDMA Femtocell Transceiver with GSM Monitoring

Table 48. TXLO_AFCDAC Register 30 (Address = 11110)

80BIT	BIT ID	NAME	DEFINITION	BIT	BAND I RX1 ONLY	DCS RX2 ONLY	BAND V RX3 ONLY	BAND VIII RX3 ONLY	BAND V RX4 ONLY	BAND VIII RX4 ONLY	BAND I RX5 ONLY	BAND I TXH ONLY	BAND V TXL ONLY	BAND VIII TXL ONLY	BAND I RX1/TXH FDD	BAND V RX3/TXL FDD	BAND VIII RX3/TXL FDD	BAND I RX IDLE	BAND I TX IDLE	AFC ONLY	REFERENCE BUFFER	SLEEP							
0	AFCDAC <11:0>	AFCDAC Output Voltage	800 (hex) $V_{AFCOUT} = 0.4 + (2.5 - 0.4) \times AFCDAC/2^{12}$	0	0	0	0	0	0	0	0	0	0	0	0	0	0	0	0	0	0	0							
1				0	0	0	0	0	0	0	0	0	0	0	0	0	0	0	0	0	0	0	0	0					
2				0	0	0	0	0	0	0	0	0	0	0	0	0	0	0	0	0	0	0	0	0	0				
3				0	0	0	0	0	0	0	0	0	0	0	0	0	0	0	0	0	0	0	0	0	0	0			
4				0	0	0	0	0	0	0	0	0	0	0	0	0	0	0	0	0	0	0	0	0	0	0			
5				0	0	0	0	0	0	0	0	0	0	0	0	0	0	0	0	0	0	0	0	0	0	0	0		
6				0	0	0	0	0	0	0	0	0	0	0	0	0	0	0	0	0	0	0	0	0	0	0	0		
7				0	0	0	0	0	0	0	0	0	0	0	0	0	0	0	0	0	0	0	0	0	0	0	0	0	
8				0	0	0	0	0	0	0	0	0	0	0	0	0	0	0	0	0	0	0	0	0	0	0	0	0	
9				0	0	0	0	0	0	0	0	0	0	0	0	0	0	0	0	0	0	0	0	0	0	0	0	0	
10				0	0	0	0	0	0	0	0	0	0	0	0	0	0	0	0	0	0	0	0	0	0	0	0	0	
11				1	1	1	1	1	1	1	1	1	1	1	1	1	1	1	1	1	1	1	1	1	1	1	1	1	
12	Reserved	Reserved	—	0	0	0	0	0	0	0	0	0	0	0	0	0	0	0	0	0	0	0	0	0	0				
13				1	0	0	0	0	0	0	0	0	0	0	0	0	0	0	0	0	0	0	0	0	0	0	0		
14				2	0	0	0	0	0	0	0	0	0	0	0	0	0	0	0	0	0	0	0	0	0	0	0	0	
15				3	0	0	0	0	0	0	0	0	0	0	0	0	0	0	0	0	0	0	0	0	0	0	0	0	
16				4	0	0	0	0	0	0	0	0	0	0	0	0	0	0	0	0	0	0	0	0	0	0	0	0	
17				5	0	0	0	0	0	0	0	0	0	0	0	0	0	0	0	0	0	0	0	0	0	0	0	0	
18				6	0	0	0	0	0	0	0	0	0	0	0	0	0	0	0	0	0	0	0	0	0	0	0	0	
19	AFCDAC_EN	AFCDAC Enable	0 = Disable 1 = Enable	0	1	1	1	1	1	1	1	1	1	1	1	1	1	1	1	1	1	1	0	0	0				
20	Reserved	Reserved	—	0	0	0	0	0	0	0	0	0	0	0	0	0	0	0	0	0	0	0	0	0	0	0			
21				1	0	0	0	0	0	0	0	0	0	0	0	0	0	0	0	0	0	0	0	0	0	0	0	0	
22				2	0	0	0	0	0	0	0	0	0	0	0	0	0	0	0	0	0	0	0	0	0	0	0	0	0
23				3	0	0	0	0	0	0	0	0	0	0	0	0	0	0	0	0	0	0	0	0	0	0	0	0	0
24				4	0	0	0	0	0	0	0	0	0	0	0	0	0	0	0	0	0	0	0	0	0	0	0	0	0
25				5	0	0	0	0	0	0	0	0	0	0	0	0	0	0	0	0	0	0	0	0	0	0	0	0	0

MAX2550

Band I, V, and VIII WCDMA Femtocell Transceiver with GSM Monitoring

Table 49. Reserved Register 31 (Address = 11111)

BIT	BIT ID	DEFINITION	BIT	BAND I RX1 ONLY	DCS RX2 ONLY	BAND V RX3 ONLY	BAND VIII RX3 ONLY	BAND V RX4 ONLY	BAND VIII RX4 ONLY	BAND I RX5 ONLY	BAND I TXH ONLY	BAND V TXL ONLY	BAND VIII TXL ONLY	BAND I RX1/TXH FDD	BAND V RX3/TXL FDD	BAND VIII RX3/TXL FDD	BAND I RX IDLE	BAND I TX IDLE	AFC ONLY	REFERENCE BUFFER	SLEEP		
0	Reserved	Reserved	0	0	0	0	0	0	0	0	0	0	0	0	0	0	0	0	0	0	0		
1			1	0	0	0	0	0	0	0	0	0	0	0	0	0	0	0	0	0	0	0	
2			2	1	1	1	1	1	1	1	1	1	1	1	1	1	1	1	1	1	1	1	1
3			3	1	1	1	1	1	1	1	1	1	1	1	1	1	1	1	1	1	1	1	1
4			4	0	0	0	0	0	0	0	0	0	0	0	0	0	0	0	0	0	0	0	0
5			5	0	0	0	0	0	0	0	0	0	0	0	0	0	0	0	0	0	0	0	0
6			6	0	0	0	0	0	0	0	0	0	0	0	0	0	0	0	0	0	0	0	0
7			7	0	0	0	0	0	0	0	0	0	0	0	0	0	0	0	0	0	0	0	0
8			8	0	0	0	0	0	0	0	0	0	0	0	0	0	0	0	0	0	0	0	0
9			9	0	0	0	0	0	0	0	0	0	0	0	0	0	0	0	0	0	0	0	0
10			10	0	0	0	0	0	0	0	0	0	0	0	0	0	0	0	0	0	0	0	0
11			11	0	0	0	0	0	0	0	0	0	0	0	0	0	0	0	0	0	0	0	0
12			12	0	0	0	0	0	0	0	0	0	0	0	0	0	0	0	0	0	0	0	0
13			13	0	0	0	0	0	0	0	0	0	0	0	0	0	0	0	0	0	0	0	0
14			14	0	0	0	0	0	0	0	0	0	0	0	0	0	0	0	0	0	0	0	0
15			15	0	0	0	0	0	0	0	0	0	0	0	0	0	0	0	0	0	0	0	0
16			16	0	0	0	0	0	0	0	0	0	0	0	0	0	0	0	0	0	0	0	0
17			17	1	1	1	1	1	1	1	1	1	1	1	1	1	1	1	1	1	1	1	1
18			18	1	1	1	1	1	1	1	1	1	1	1	1	1	1	1	1	1	1	1	1
19			19	1	1	1	1	1	1	1	1	1	1	1	1	1	1	1	1	1	1	1	1
20			20	0	0	0	0	0	0	0	0	0	0	0	0	0	0	0	0	0	0	0	0
21			21	1	1	1	1	1	1	1	1	1	1	1	1	1	1	1	1	1	1	1	1
22			22	0	0	0	0	0	0	0	0	0	0	0	0	0	0	0	0	0	0	0	0
23			23	0	0	0	0	0	0	0	0	0	0	0	0	0	0	0	0	0	0	0	0
24			24	0	0	0	0	0	0	0	0	0	0	0	0	0	0	0	0	0	0	0	0
25			25	0	0	0	0	0	0	0	0	0	0	0	0	0	0	0	0	0	0	0	0

MAX2550

Band I, V, and VIII WCDMA Femtocell Transceiver with GSM Monitoring

Applications Information

Layout Considerations

The EV kit and reference design serve as a guide for PCB layout. Keep RF signal lines as short as possible to minimize losses and radiation. Use controlled impedance

on all high-frequency traces. The exposed pad must be soldered evenly to the board's ground plane for proper operation. Use abundant ground vias between RF traces to minimize undesired coupling. Bypass each $V_{CC_}$ pin to ground with capacitors placed as close as possible to the pin.

Simplified Block Diagram

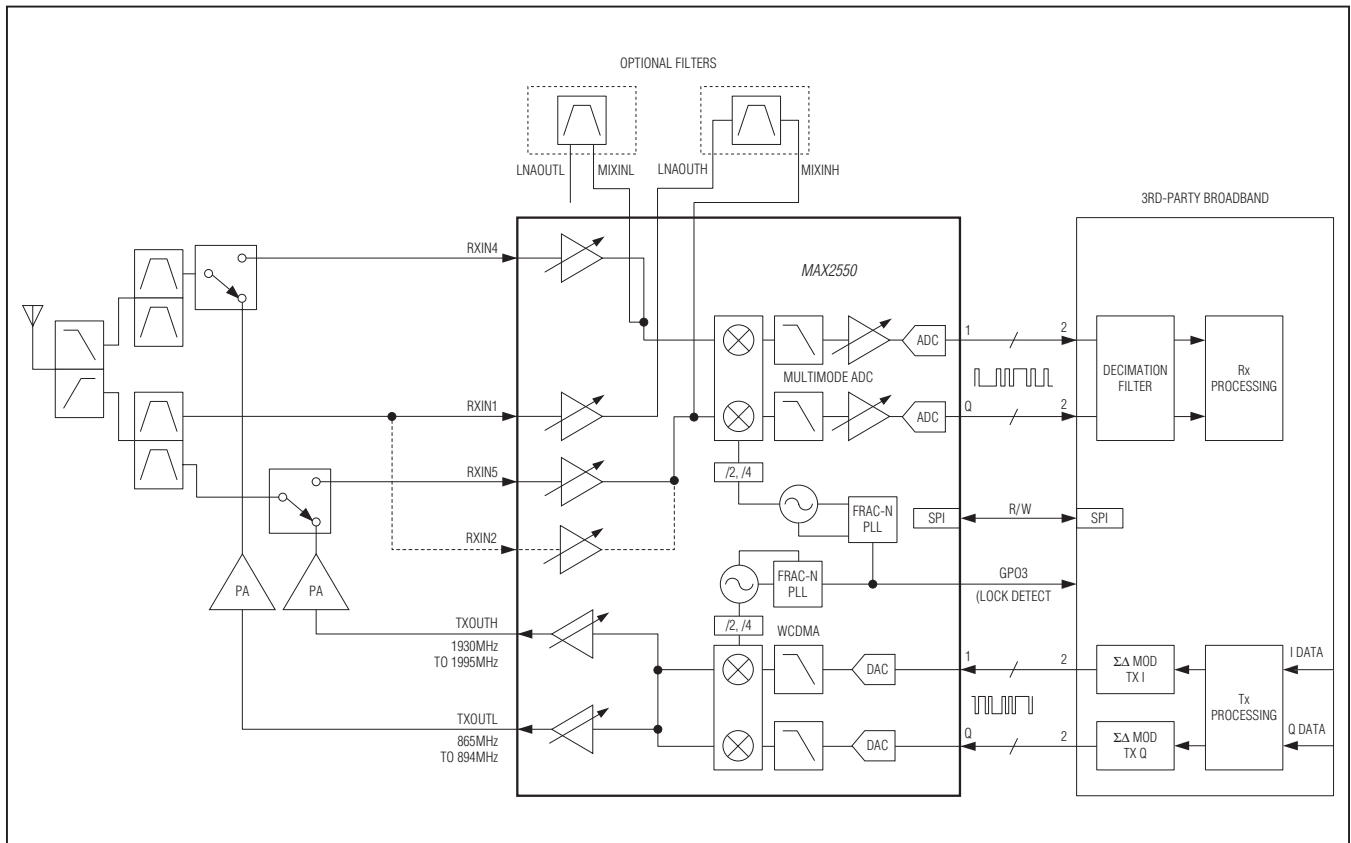

Ordering Information

PART	BAND	TEMP RANGE	PIN-PACKAGE
MAX2550ETN+	I, V, and VIII	-40°C to +85°C	56 TQFN-EP*

+Denotes a lead(Pb)-free/RoHS-compliant package.

*EP = Exposed pad.

Package Information

For the latest package outline information and land patterns (footprints), go to www.maxim-ic.com/packages. Note that a "+", "#", or "-" in the package code indicates RoHS status only. Package drawings may show a different suffix character, but the drawing pertains to the package regardless of RoHS status.

PACKAGE TYPE	PACKAGE CODE	OUTLINE NO.	LAND PATTERN NO.
56 TQFN-EP	T5677+2	21-0144	90-0043

MAX2550

Band I, V, and VIII WCDMA Femtocell Transceiver with GSM Monitoring

Revision History

REVISION NUMBER	REVISION DATE	DESCRIPTION	PAGES CHANGED
0	7/12	Initial release	—



Maxim cannot assume responsibility for use of any circuitry other than circuitry entirely embodied in a Maxim product. No circuit patent licenses are implied. Maxim reserves the right to change the circuitry and specifications without notice at any time. The parametric values (min and max limits) shown in the Electrical Characteristics table are guaranteed. Other parametric values quoted in this data sheet are provided for guidance.

Maxim Integrated 160 Rio Robles, San Jose, CA 95134 USA 1-408-601-1000

102