

## MAX33250E Shield

Evaluates: MAX33250E

### General Description

The MAX33250E Shield is a fully assembled and tested PCB that demonstrates the functionality of the MAX33250E, isolated 2Tx/2Rx RS-232 transceivers, with a galvanic isolation of 600V<sub>RMS</sub> (60sec) between the logic UART side and field side. The isolation barrier protects the logic UART side from electrical transient strikes from the field side. It also breaks ground loops and large differences in ground potentials between the two sides that can potentially corrupt the receiving and sending of data. The MAX33250E conforms to the EIA/TIA-232E standard and operates at data rates up to 1Mbps.

### Features

- Single Supply
- On-Board Isolation Power Supply
- Arduino/Mbed Shield Interface and Form Factor
- DCE/DTE Selectable DB9 Pinout

[Ordering Information](#) appears at end of data sheet.

### Quick Start

#### Required Equipment

- MAX33250E Shield
- 5V, 500mA DC power supply
- Function generator
- Digital oscilloscope with 2 input channels

#### Procedure

The Shield EV kit is fully assembled and tested. Follow the steps below to verify board operation:

- 1) Place the MAX33250E Shield on a nonconductive surface to ensure that nothing on the PCB gets shorted to the workspace.
- 2) Make sure all jumpers are in their default positions as shown in [Table 1](#).
- 3) Connect T1OUT test point to R1IN test point.
- 4) Connect T2OUT test point to R2IN test point.
- 5) Disable the output of the function generator.
- 6) Set the output of the function generator to 500kHz (min = 0V, max = 5V) square wave.
- 7) Connect the positive terminal of the function generator to T1IN and T2IN test points.
- 8) Connect the negative terminal of the function generator to GNDA connector.
- 9) Connect the positive terminal of 5V supply to VCCA\_EXT connector.
- 10) Connect the negative terminal of 5V supply to GNDA connector.
- 11) Connect the positive terminal of channel 1 of the oscilloscope to R1OUT test point.
- 12) Connect the negative terminal of channel 1 of the oscilloscope to GNDA connector.
- 13) Connect the positive terminal of channel 2 of the oscilloscope to R2OUT test point.
- 14) Connect the negative terminal of channel 2 of the oscilloscope to GNDA connector.
- 15) Enable the output of the function generator.
- 16) Verify 500kHz 5V square waves appear on both channels of the oscilloscope.

## Detailed Description of Hardware

MAX33250E Shield is fully assembled and tested circuit board for evaluating the MAX33250E 1Mbps, 600V<sub>RMS</sub> isolated RS-232 transceivers. The MAX33250E has 2 transmitters and 2 receivers (2Tx/2Rx). The isolation is provided by Maxim's proprietary insulation material that can withstand 600V<sub>RMS</sub> for 60 seconds. The MAX33250E conforms to the EIA/TIA-232 standard and operates at data rates up to 1Mbps over the temperature range of -40°C to +85°C.

The MAX33250E Shield, with an onboard DB9 connector, enables Mbed or Arduino platforms to communicate on an RS-232 bus. DCE/DTE DB9 pinout is selectable with the SW1 switch. The MAX14850 digital isolator is used as a level translator with a 3V to 5.5V supply range.

## Powering the Board

VCCA of MAX33250E can come from external supply or the Arduino/Mbed platform supply. See [Table 1](#) for jumper settings to select appropriate VCCA source.

The MAX33250E Shield has an on-board isolated power supply that generates an isolated supply for VCCB. If the shield board is connected to a Arduino/Mbed platform, input of the isolated power supply is connected to the 5V output (pin 4 of J3) of the Arduino/Mbed platform. The voltage generated on the isolated output is same as the input. See [Table 1](#) for jumper settings to select appropriate VCCB source.

**Table 1. Jumper Settings**

JUMPER	SHUNT POSITION	DESCRIPTION
JU1	1-2	Transceiver VCCA connects to 3.3V on Arduino/Mbed connector (J3)
	1-3	Transceiver VCCA connects to 5V on Arduino/Mbed connector (J3)
	1-4*	Transceiver VCCA connects to VCCA_EXT connector
JU2	1-2*	Transceiver VCCB connects to the output of the isolated power supply
	2-3	Transceiver VCCB connects to VCCB_EXT connector
JU3	1-2*	Transceiver T1IN connects to the level translator
	OPEN	Transceiver T1IN disconnects from the level translator
JU4	1-2*	Transceiver T2IN connects to the level translator
	OPEN	Transceiver T2IN disconnects from the level translator
JU5	1-2*	Transceiver R1OUT connects to the level translator
	OPEN	Transceiver R1OUT disconnects from the level translator
JU6	1-2*	Transceiver R2OUT connects to the level translator
	OPEN	Transceiver R2OUT disconnects from the level translator
JU1D0	1-2	Transceiver T2IN connects to Arduino/Mbed connector's D0 signal
	2-3*	Transceiver R2OUT connects to Arduino/Mbed connector's D0 signal
	OPEN	Arduino/Mbed connector's D0 signal is not connected
JU1D1	1-2*	Transceiver T2IN connects to Arduino/Mbed connector's D1 signal
	2-3	Transceiver R2OUT connects to Arduino/Mbed connector's D1 signal
	OPEN	Arduino/Mbed connector's D1 signal is not connected
JU1D2	1-2	Transceiver T2IN connects to Arduino/Mbed connector's D2 signal
	2-3	Transceiver R2OUT connects to Arduino/Mbed connector's D2 signal
	OPEN*	Arduino/Mbed connector's D2 signal is not connected

Table 1. Jumper Settings (continued)

JUMPER	SHUNT POSITION	DESCRIPTION
JU1D3	1-2	Transceiver T2IN connects to Arduino/Mbed connector's D3 signal
	2-3	Transceiver R2OUT connects to Arduino/Mbed connector's D3 signal
	OPEN*	Arduino/Mbed connector's D3 signal is not connected
JU1D4	1-2	Transceiver T2IN connects to Arduino/Mbed connector's D4 signal
	2-3	Transceiver R2OUT connects to Arduino/Mbed connector's D4 signal
	OPEN*	Arduino/Mbed connector's D4 signal is not connected
JU1D5	1-2	Transceiver T2IN connects to Arduino/Mbed connector's D5 signal
	2-3	Transceiver R2OUT connects to Arduino/Mbed connector's D5 signal
	OPEN*	Arduino/Mbed connector's D5 signal is not connected
JU1D6	1-2	Transceiver T2IN connects to Arduino/Mbed connector's D6 signal
	2-3	Transceiver R2OUT connects to Arduino/Mbed connector's D6 signal
	OPEN*	Arduino/Mbed connector's D6 signal is not connected
JU1D7	1-2	Transceiver T2IN connects to Arduino/Mbed connector's D7 signal
	2-3	Transceiver R2OUT connects to Arduino/Mbed connector's D7 signal
	OPEN*	Arduino/Mbed connector's D7 signal is not connected
JU1D8	1-2	Transceiver T2IN connects to Arduino/Mbed connector's D8 signal
	2-3	Transceiver R2OUT connects to Arduino/Mbed connector's D8 signal
	OPEN*	Arduino/Mbed connector's D8 signal is not connected
JU1D9	1-2	Transceiver T2IN connects to Arduino/Mbed connector's D9 signal
	2-3	Transceiver R2OUT connects to Arduino/Mbed connector's D9 signal
	OPEN*	Arduino/Mbed connector's D9 signal is not connected
JU2D0	1-2	Transceiver T1IN connects to Arduino/Mbed connector's D0 signal
	2-3*	Transceiver R1OUT connects to Arduino/Mbed connector's D0 signal
	OPEN	Arduino/Mbed connector's D0 signal is not connected
JU2D1	1-2*	Transceiver T1IN connects to Arduino/Mbed connector's D1 signal
	2-3	Transceiver R1OUT connects to Arduino/Mbed connector's D1 signal
	OPEN	Arduino/Mbed connector's D1 signal is not connected
JU2D2	1-2	Transceiver T1IN connects to Arduino/Mbed connector's D2 signal
	2-3	Transceiver R1OUT connects to Arduino/Mbed connector's D2 signal
	OPEN*	Arduino/Mbed connector's D2 signal is not connected
JU2D3	1-2	Transceiver T1IN connects to Arduino/Mbed connector's D3 signal
	2-3	Transceiver R1OUT connects to Arduino/Mbed connector's D3 signal
	OPEN*	Arduino/Mbed connector's D3 signal is not connected
JU2D4	1-2	Transceiver T1IN connects to Arduino/Mbed connector's D4 signal
	2-3	Transceiver R1OUT connects to Arduino/Mbed connector's D4 signal
	OPEN*	Arduino/Mbed connector's D4 signal is not connected

**Table 1. Jumper Settings (continued)**

JUMPER	SHUNT POSITION	DESCRIPTION
JU2D5	1-2	Transceiver T1IN connects to Arduino/Mbed connector's D5 signal
	2-3	Transceiver R1OUT connects to Arduino/Mbed connector's D5 signal
	OPEN*	Arduino/Mbed connector's D5 signal is not connected
JU2D6	1-2	Transceiver T1IN connects to Arduino/Mbed connector's D6 signal
	2-3	Transceiver R1OUT connects to Arduino/Mbed connector's D6 signal
	OPEN*	Arduino/Mbed connector's D6 signal is not connected
JU2D7	1-2	Transceiver T1IN connects to Arduino/Mbed connector's D7 signal
	2-3	Transceiver R1OUT connects to Arduino/Mbed connector's D7 signal
	OPEN*	Arduino/Mbed connector's D7 signal is not connected
JU2D8	1-2	Transceiver T1IN connects to Arduino/Mbed connector's D8 signal
	2-3	Transceiver R1OUT connects to Arduino/Mbed connector's D8 signal
	OPEN*	Arduino/Mbed connector's D8 signal is not connected
JU2D9	1-2	Transceiver T1IN connects to Arduino/Mbed connector's D9 signal
	2-3	Transceiver R1OUT connects to Arduino/Mbed connector's D9 signal
	OPEN*	Arduino/Mbed connector's D9 signal is not connected

\*Default position.

**Ordering Information**

PART	TYPE
MAX33250ESHLD#	SHIELD

#Denotes RoHS compliant.

MAX33250E Shield Bill of Materials

ITEM	REF_DES	QTY	VALUE	DESCRIPTION	MFG PART #	MANUFACTURER
1	C1, C2	2	10UF	CAPACITOR; SMT (0603); CERAMIC CHIP; 10UF; 10V; TOL=10%; MODEL=; TG=-55 DEGC TO +85 DEGC; TC=X5R	C1608X5R1A106K	TDK
2	C3-C7	5	0.1UF	CAPACITOR; SMT (0603); CERAMIC CHIP; 0.1UF; 10V; TOL=10%; MODEL=C0603 SERIES; TG=-55 DEGC TO +125 DEGC; TC=X7R	C0603C104K8RAC	KEMET
3	C8	1	0.33UF	CAPACITOR; SMT (0603); CERAMIC CHIP; 0.33uF; 16V; TOL=10%; MODEL=; TG=-55 DEGC TO +125 DEGC; TC=X7R	C0603C334K4RAC	KEMET
4	D1, D2	2	MBR0520L	DIODE, SCHOTTKY, SOD-123, PIV=20V, Vf=0.385V@If=0.5A, If(ave)=0.5A	MBR0520L	FAIRCHILD SEMICONDUCTOR
5	D3	1	5.1V	DIODE; ZNR; SMT (SOD-123); VZ=5.1V; IZ=0.02A	MMSZ5231B-7-F	DIODES INCORPORATED
6	GNDA, GNDB	2	N/A	TEST POINT; PIN DIA=0.125IN; TOTAL LENGTH=0.35IN; BOARD HOLE=0.063IN; BLACK; PHOSPHOR BRONZE WIRE SILVER PLATE FINISH;	5006	KEYSTONE
7	J3, J6	2	SSQ-108-04-G-S	CONNECTOR; FEMALE; THROUGH HOLE; .025IN SQ POST SOCKET; STRAIGHT; 8PINS ;	SSQ-108-04-G-S	SAMTEC
8	J4	1	SSQ-106-04-G-S	CONNECTOR; FEMALE; THROUGH HOLE; .025IN SQ POST SOCKET; STRAIGHT; 6PINS ;	SSQ-106-04-G-S	SAMTEC
9	J5	1	SSQ-110-04-G-S	CONNECTOR; FEMALE; THROUGH HOLE; .025IN SQ POST SOCKET; STRAIGHT; 10PINS ;	SSQ-110-04-G-S	SAMTEC
10	JU1	1	PEC04SAAN	CONNECTOR; MALE; THROUGH HOLE; BREAKAWAY; STRAIGHT; 4PINS	PEC04SAAN	SULLINS ELECTRONICS CORP.
11	JU1D0-JU1D3, JU1D6-JU1D9, JU2, JU2D0-JU2D3, JU2D6-JU2D9	17	PEC03SAAN	CONNECTOR; MALE; THROUGH HOLE; BREAKAWAY; STRAIGHT; 3PINS	PEC03SAAN	SULLINS
12	JU3-JU6	4	PBC02SAAN	EVKIT PART-CONNECTOR; MALE; THROUGH HOLE; BREAKAWAY; STRAIGHT; 2PINS; -65 DEGC TO +125 DEGC;	PBC02SAAN	SULLINS ELECTRONICS CORP.
13	P1	1	182-009-213R531	CONNECTOR; FEMALE; THROUGH HOLE; D-SUBMINIATURE CONNECTOR; RIGHT ANGLE; 9PINS	182-009-213R531	NORCOMP
14	R1IN, R1OUT, R2IN, R2OUT, T1IN, T1OUT, T2IN, T2OUT	8	N/A	TEST POINT; PIN DIA=0.1IN; TOTAL LENGTH=0.3IN; BOARD HOLE=0.04IN; YELLOW; PHOSPHOR BRONZE WIRE SILVER PLATE FINISH;	5004	KEYSTONE
15	SW1	1	MFS401N-2-Z	SWITCH; 4PDT; THROUGH HOLE; STRAIGHT; +5V TO +30V; 0.01A-0.3A; MFS SERIES; RCONTACT=0.02 OHM; RINSULATION=100M OHM	MFS401N-2-Z	NIDEC COPAL ELECTRONICS CORP
16	T1	1	TGM-050P3RL	TRANSFORMER; SMT; 1:1:1:1; PCMCIA DC/DC CONVERTER	TGM-050P3RL	HALO ELECTRONICS INC
17	U1	1	MAX33250E	EVKIT PART-IC; MAX33250E; LGA12; 6X6MM; 1MM PITCH; PACKAGE OUTLINE DRAWING: 21-100222; PACKAGE CODE: L1266M+1	MAX33250E	MAXIM
18	U2	1	MAX14850AEE+	IC; ISO; SIX-CHANNEL DIGITAL ISOLATOR; QSOP16	MAX14850AEE+	MAXIM
19	U3	1	MAX845EUA+	IC; DRV; ISOLATED TRANSFORMER DRIVER; UMAX8	MAX845EUA+	MAXIM
20	VCCA_EXT, VCCB_EXT	2	N/A	TEST POINT; PIN DIA=0.125IN; TOTAL LENGTH=0.35IN; BOARD HOLE=0.063IN; RED; PHOSPHOR BRONZE WIRE SILVER PLATE FINISH;	5005	KEYSTONE
21	PCB	1	PCB	PCB:MAX33250_SHIELD_APPS_A	MAX33250_SHIELD_APPS_A	MAXIM
22	R1, R2	0	DNP	RESISTOR; 0603; OPEN; FORMFACTOR	N/A	N/A
23	C9, C10	0	DNP	CAPACITOR; SMT (0603); OPEN; FORMFACTOR	N/A	N/A

MAX33250E Shield Schematic

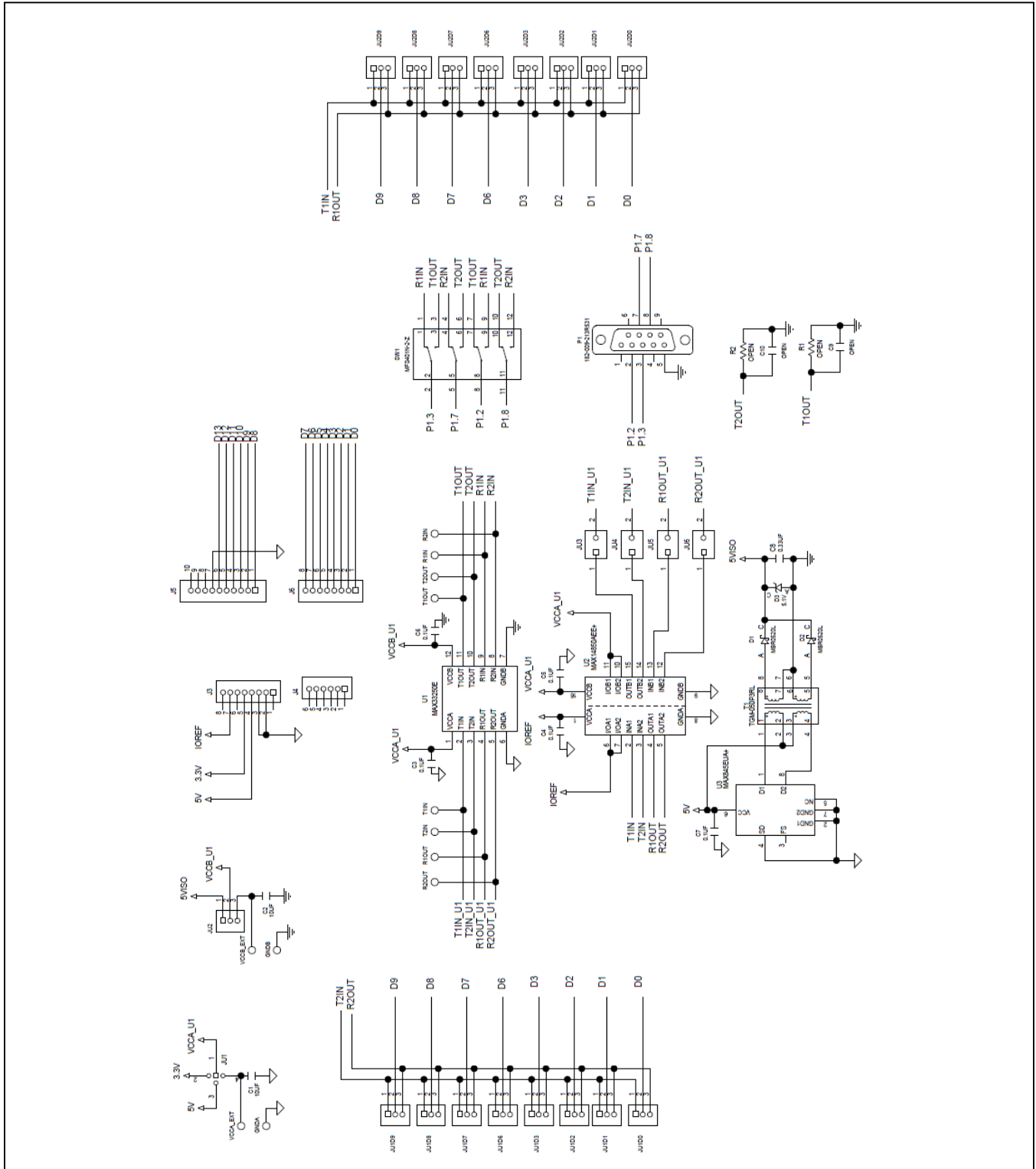

MAX33250E Shield PCB Layout Diagrams

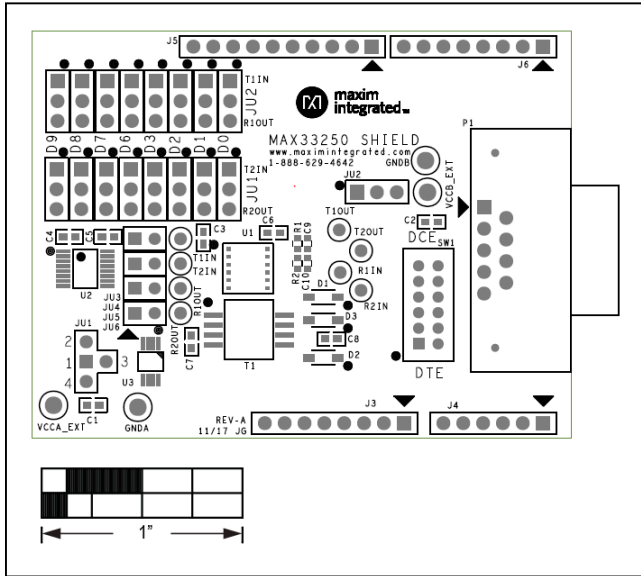

MAX33250E Shield—Top Silkscreen

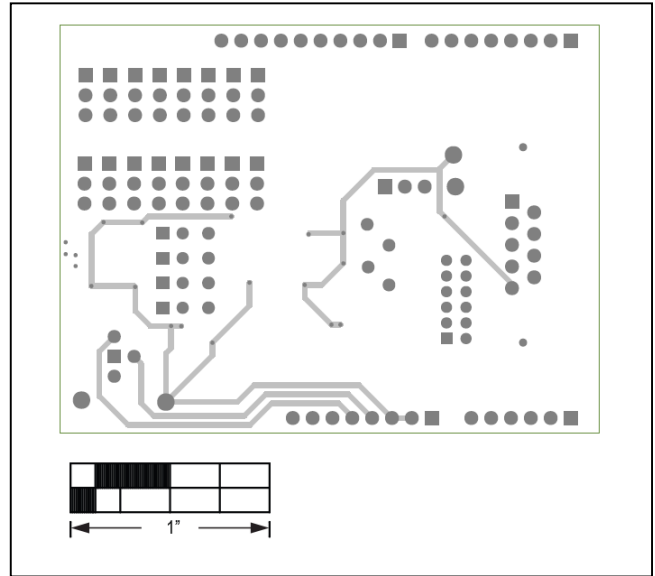

MAX33250E Shield—Internal 2

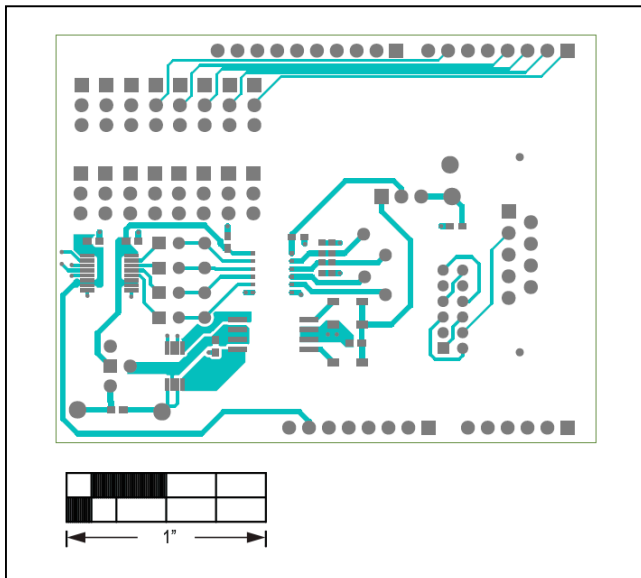

MAX33250E Shield—Top

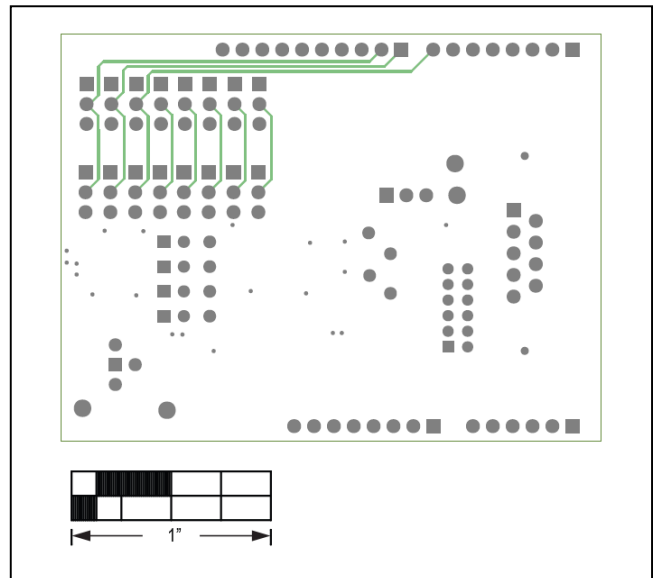

MAX33250E Shield—Internal 3

MAX33250E Shield PCB Layout Diagrams (continued)

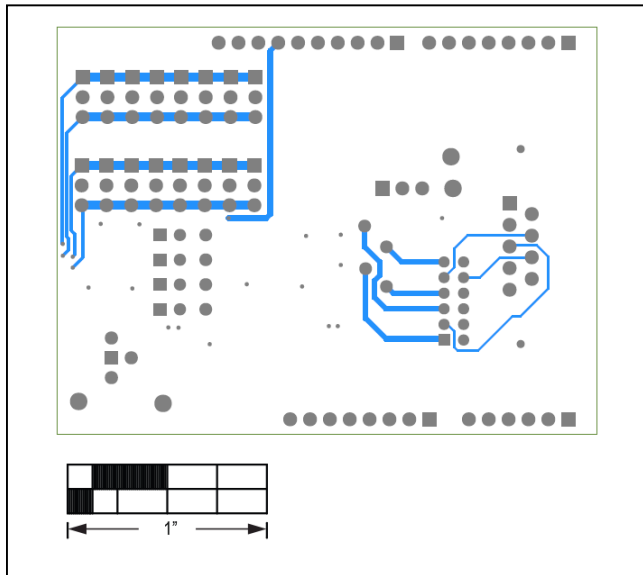

MAX33250E Shield—Bottom

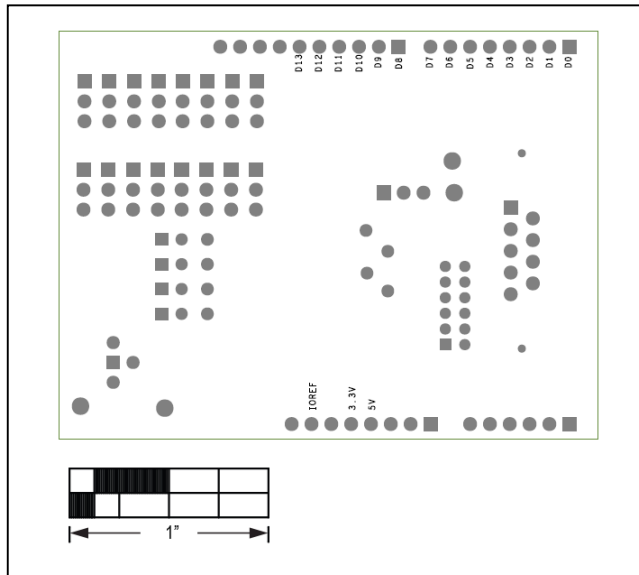

MAX33250E Shield—Bottom Silkscreen



## Revision History

REVISION NUMBER	REVISION DATE	DESCRIPTION	PAGES CHANGED
0	9/18	Initial release	—

For pricing, delivery, and ordering information, please visit Maxim Integrated's online storefront at <https://www.maximintegrated.com/en/storefront/storefront.html>.

*Maxim Integrated cannot assume responsibility for use of any circuitry other than circuitry entirely embodied in a Maxim Integrated product. No circuit patent licenses are implied. Maxim Integrated reserves the right to change the circuitry and specifications without notice at any time.*