

## MAX38909

## 2A High-Performance nMOS LDO Linear Regulator

### General Description

The MAX38909 is a fast transient response, high PSRR nMOS linear regulator that delivers up to 2A of load current.

The regulator supports a wide input supply range from 0.9V to 5.5V, and BIAS voltage range from 2.7V to 20V to provide wider supply options in a variety of applications.  $\pm 1\%$  output accuracy is maintained over line, load, and temperature variations, requiring only 300mV of input-to-output headroom at full load for a good PSRR. The output voltage can be adjusted to accommodate customers that desire to specify a single LDO in the BOM for multiple voltage rails.

The output voltage on the MAX38909 is programmed to a value in the range of 0.6V to 5.0V by using two external feedback resistors.

The LDO is fully protected from damage by internal circuitry that provides programmable inrush current limiting, output overcurrent limiting, reverse-current limiting, and thermal overload protection.

The MAX38909 is offered in 14-pin, 3mm x 3mm TDFN and 5 x 3 bump, 0.4mm pitch WLP packages.

### Applications

- FPGAs and DSPs
- Medical, Audio, and Instrumentation
- Server Microcontrollers
- Portable Cameras
- PLCs
- Base Stations

### Benefits and Features

- Delivers Flexible Operating Range
  - 0.9V to 5.5V Input Voltage Range
  - 2.7V to 20V BIAS Voltage Range
  - 0.6V to 5.0V Programmable Output Voltage
  - 2A Maximum Output Current
  - 27mV Dropout at 2A Load Current
  - 1.6mA Operating BIAS Supply Current
- Reduces Noise and Improves Accuracy
  - $\pm 1\%$  DC Accuracy Over Load, Line, and Temperature
  - 15mV 2A Load Transient Excursion
  - 52dB IN PSRR at 10kHz at 300mV Input-to-Output Headroom
- Enables Ease-of-Use and Robust Protection
  - Stable with 10 $\mu$ F (Minimum) Output Capacitance
  - Programmable Soft-Start Rate
  - Overcurrent and Overtemperature Protection
  - Output-to-Input Reverse Current Protection
  - Power-OK Status Pin
- Reduces Size, Improves Reliability
  - 14-Pin (3mm x 3mm) TDFN and 5 x 3 Bump, 0.4mm Pitch WLP Packages
  - -40°C to +125°C Operating Temperature

[Ordering Information](#) appears at end of data sheet.

Typical Application Circuit

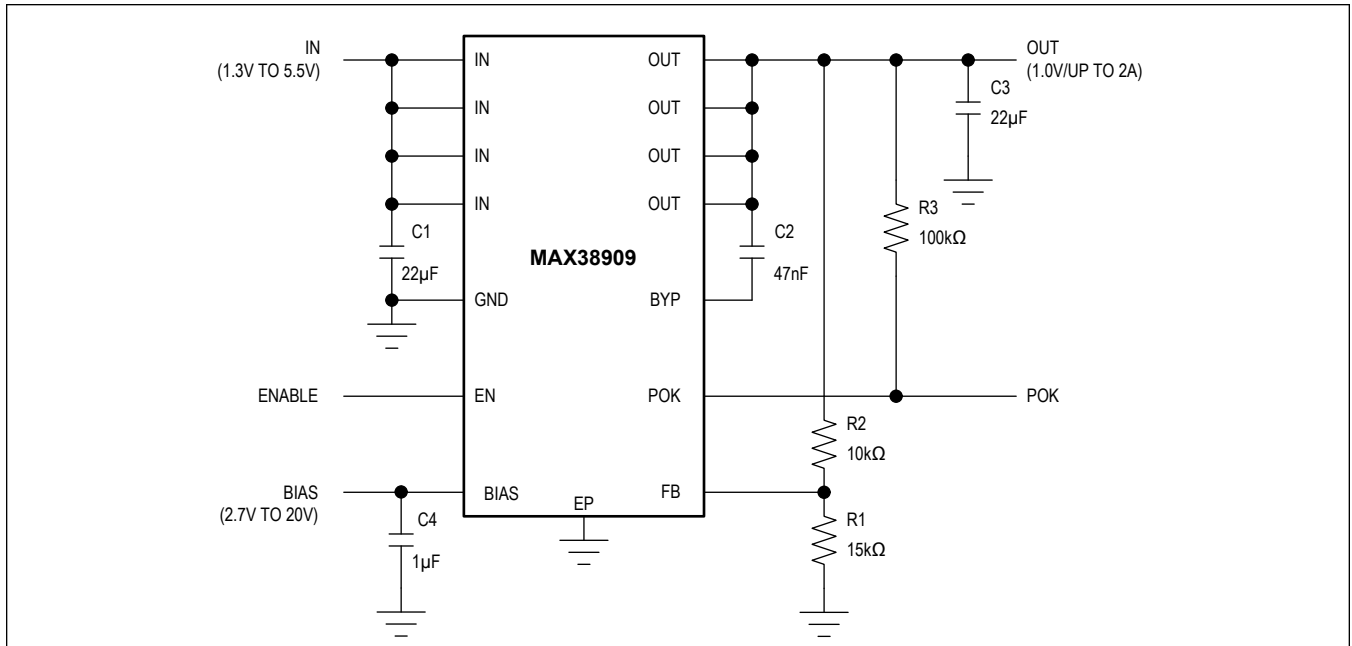

---

**TABLE OF CONTENTS**

---

General Description . . . . .	1
Applications . . . . .	1
Benefits and Features . . . . .	1
Typical Application Circuit . . . . .	2
Absolute Maximum Ratings . . . . .	6
Package Information . . . . .	6
14 TDFN . . . . .	6
WLP . . . . .	6
Electrical Characteristics . . . . .	6
Typical Operating Characteristics . . . . .	9
Pin Configurations . . . . .	12
14 TDFN . . . . .	12
WLP . . . . .	12
Pin Description . . . . .	12
Functional Diagram . . . . .	13
Detailed Description . . . . .	14
Enable . . . . .	14
Bypass . . . . .	14
Power OK . . . . .	14
Protection . . . . .	15
Undervoltage Lockout (UVLO) . . . . .	16
Active Discharge . . . . .	17
Voltage Selection . . . . .	17
Applications Information . . . . .	19
Input and Output Capacitors . . . . .	19
Thermal Design . . . . .	19
Ordering Information . . . . .	19
Revision History . . . . .	20

---

**LIST OF FIGURES**

---

Figure 1. Typical POK Operation ..... 15  
Figure 2. Typical IN UVLO Operation ..... 16  
Figure 3. Startup into Dropout ..... 17

---

**LIST OF TABLES**

---

Table 1. Recommended Feedback Resistor Values . . . . . 18

**Absolute Maximum Ratings**

IN, FB, OUT, BYP, POK to GND .....	-0.3V to +6V	WLP (derate 16.2mW/°C, T <sub>A</sub> = +70°C).....	1312mW
BIAS to GND .....	-0.3V to +22V	Operating Junction Temperature.....	-40°C to +125°C
EN to GND.....	-0.3V to V <sub>BIAS</sub> + 0.3V	Maximum Junction Temperature .....	+150°C
Output Short-Circuit Duration .....	Continuous	Storage Temperature Range .....	-65°C to +150°C
Continuous Power Dissipation (T <sub>A</sub> = +70°C)		Lead Temperature (soldering, 10s).....	+300°C
TDFN (derate 24.4mW/°C, T <sub>A</sub> = +70°C).....	1951.2mW		

Stresses beyond those listed under "Absolute Maximum Ratings" may cause permanent damage to the device. These are stress ratings only, and functional operation of the device at these or any other conditions beyond those indicated in the operational sections of the specifications is not implied. Exposure to absolute maximum rating conditions for extended periods may affect device reliability.

**Package Information**

**14 TDFN**

Package Code	T1433+2C
Outline Number	<a href="#">21-0137</a>
Land Pattern Number	<a href="#">90-0063</a>
<b>Thermal Resistance, Single-Layer Board:</b>	
Junction to Ambient (θ <sub>JA</sub> )	54°C/W
Junction to Case (θ <sub>JC</sub> )	8°C/W
<b>Thermal Resistance, Four-Layer Board:</b>	
Junction to Ambient (θ <sub>JA</sub> )	41°C/W
Junction to Case (θ <sub>JC</sub> )	8°C/W

**WLP**

Package Code	N151C2+1
Outline Number	<a href="#">21-100372</a>
Land Pattern Number	Refer to <a href="#">Application Note 1891</a>
<b>Thermal Resistance, Four-Layer Board:</b>	
Junction to Ambient (θ <sub>JA</sub> )	61.65°C/W
Junction to Case (θ <sub>JC</sub> )	N/A

For the latest package outline information and land patterns (footprints), go to [www.maximintegrated.com/packages](http://www.maximintegrated.com/packages). Note that a "+", "#", or "-" in the package code indicates RoHS status only. Package drawings may show a different suffix character, but the drawing pertains to the package regardless of RoHS status.

Package thermal resistances were obtained using the method described in JEDEC specification JESD51-7, using a four-layer board. For detailed information on package thermal considerations, refer to [www.maximintegrated.com/thermal-tutorial](http://www.maximintegrated.com/thermal-tutorial).

**Electrical Characteristics**

(V<sub>IN</sub> = 1.5V, V<sub>OUT</sub> = 1.0V, V<sub>BIAS</sub> = 10V, T<sub>J</sub> = -40°C to +125°C, C<sub>IN</sub> = 22µF, C<sub>OUT</sub> = 22µF, C<sub>BYP</sub> = 1nF, unless noted otherwise.)  
(*Note 1*)

PARAMETER	SYMBOL	CONDITIONS	MIN	TYP	MAX	UNITS
Input Voltage Range	V <sub>IN</sub>	Guaranteed by output accuracy, V <sub>OUT</sub> < V <sub>IN</sub> - V <sub>DO</sub>	0.9		5.5	V

## Electrical Characteristics (continued)

( $V_{IN} = 1.5V$ ,  $V_{OUT} = 1.0V$ ,  $V_{BIAS} = 10V$ ,  $T_J = -40^{\circ}C$  to  $+125^{\circ}C$ ,  $C_{IN} = 22\mu F$ ,  $C_{OUT} = 22\mu F$ ,  $C_{BYP} = 1nF$ , unless noted otherwise.)  
(*Note 1*)

PARAMETER	SYMBOL	CONDITIONS	MIN	TYP	MAX	UNITS
Bias Voltage Range	$V_{BIAS}$		2.7		20	V
Input Undervoltage Lockout	$V_{IN\_UVLO}$	$V_{IN}$ rising, 60mV hysteresis	0.35	0.45	0.55	V
Bias Undervoltage Lockout	$V_{BIAS\_UVLO}$	$V_{BIAS}$ rising, 100mV hysteresis	2.45	2.55	2.65	V
Output Voltage Range	$V_{OUT}$	Guaranteed by output accuracy	0.6		5.0	V
Output Capacitance	$C_{OUT}$	Effective capacitance required for stability and proper operation	10	22		$\mu F$
Input Supply Current	$I_Q$	$V_{EN} = 3.6V$ , $V_{BIAS} = 5.0V$ , $I_{OUT} = 0mA$		70.5	150	$\mu A$
Input Shutdown Current	$I_{SD}$	$V_{EN} = 0V$	$T_J = +25^{\circ}C$	0.001	1	$\mu A$
			$T_J = +125^{\circ}C$	1		
Bias Supply Current	$I_{BIAS}$	$V_{EN} = 3.3V$ , $V_{BIAS} = 5.0V$ , $I_{OUT} = 0mA$		1.5	4	mA
		$V_{EN} = 3.3V$ , $V_{BIAS} = 5.0V$ , $I_{OUT} = 2A$		1.6		
	$I_{BIAS\_SD}$	$V_{EN} = 0V$		0.75	4	$\mu A$
Feedback Voltage Accuracy	$V_{FB}$	$I_{OUT}$ from 10mA to 2A, $V_{IN}$ from $V_{OUT} + 0.3V$ to 5.5V, $V_{BIAS} > 2.7V$ , $V_{BIAS}$ from $V_{OUT} + 2V$ to 20V, $V_{OUT}$ from 0.6V to 5.0V	0.594	0.6	0.606	V
Load Regulation		$I_{OUT}$ from 0.1mA to 2A, $C_{BYP} = 47nF$		0.05		%
Load Transient		$I_{OUT} = 20mA$ to 2A and 2A to 20mA, $di/dt = 1A/\mu s$ , $C_{OUT} = 3 \times 10\mu F$ , $C_{BYP} = 47nF$		15		mV
Line Regulation		$V_{IN}$ from $V_{OUT} + 0.3V$ to 5.5V, $I_{OUT} = 1A$ , $C_{BYP} = 47nF$		0.04		%/V
Line Transient		$V_{IN} = 1.0V$ to 1.2V to 1.0V, 10V/ms $V_{IN}$ slew rate, $I_{OUT} = 2A$ , $V_{OUT} = 0.8V$ , $C_{BYP} = 47nF$		4.5		mV
Dropout Voltage ( <i>Note 2</i> )	$V_{DO}$	$I_{OUT} = 2A$ , $V_{OUT\_NOM} = 1.2V$	$V_{BIAS} = 5.0V$ , TDFN	36	80	mV
			$V_{BIAS} = 5.0V$ , WLP	27	80	
			$V_{BIAS} = 3.3V$ , TDFN	50	100	
			$V_{BIAS} = 3.3V$ , WLP	43	100	
		$I_{OUT} = 2A$ , $V_{OUT\_NOM} = 2.5V$	$V_{BIAS} = 5.0V$ , TDFN	44		
			$V_{BIAS} = 5.0V$ , WLP	36		
		$I_{OUT} = 2A$ , $V_{OUT\_NOM} = 5.0V$	$V_{BIAS} = 12V$ , TDFN	36		
			$V_{BIAS} = 12V$ , WLP	27		
Current Limit	$I_{LIM}$	$V_{OUTS/OUT} = 0.9 \times V_{OUT\_NOM}$ , $V_{IN} - V_{OUT} = 300mV$	2.2	2.8	3.4	A

## Electrical Characteristics (continued)

( $V_{IN} = 1.5V$ ,  $V_{OUT} = 1.0V$ ,  $V_{BIAS} = 10V$ ,  $T_J = -40^{\circ}C$  to  $+125^{\circ}C$ ,  $C_{IN} = 22\mu F$ ,  $C_{OUT} = 22\mu F$ ,  $C_{BYP} = 1nF$ , unless noted otherwise.)  
(Note 1)

PARAMETER	SYMBOL	CONDITIONS		MIN	TYP	MAX	UNITS
Output Noise		$I_{OUT} = 0.5A$ , 10Hz to 100kHz, $V_{OUT} = 1.2V$	$C_{BYP} = 47nF$		21.2		$\mu V_{RMS}$
IN Power Supply Rejection Ratio	PSRR	$V_{IN} - V_{OUT} = 0.3V$ , $I_{OUT} = 1A$ , $C_{OUT} = 4 \times 10\mu F$ , $C_{BYP} = 47nF$ , $V_{BIAS} > 2.7V$ , $V_{BIAS} = V_{OUT} + 2V$ , $T_A = +25^{\circ}C$	f = 1kHz		59		dB
			f = 10kHz		52		
			f = 100kHz		42		
BIAS Supply Rejection Ratio	PSRR	$V_{IN} - V_{OUT} = 0.3V$ , $I_{OUT} = 1A$ , $C_{OUT} = 4 \times 10\mu F$ , $C_{BYP} = 47nF$ , $V_{BIAS} = V_{OUT} + 5V$ , $T_A = +25^{\circ}C$	f = 1kHz		90		dB
			f = 10kHz		78		
			f = 100kHz		69		
BYP Capacitor Range	$C_{BYP}$	Regulator remains stable; guaranteed by design		0.001		0.1	$\mu F$
BYP Soft-Start Current	$I_{BYP}$	From BYP to GND during startup			50		$\mu A$
EN Input Threshold	$V_{IH}$	EN rising			1.0	1.6	V
	$V_{IL}$	EN falling		0.4	0.9		
EN Input Leakage Current	$I_{EN\_LK}$	$V_{EN}$ from 0V to 5.5V, $V_{BIAS}$ from 8V to 20V	$T_A = +25^{\circ}C$	-1	+0.001	+1	$\mu A$
			$T_J = +125^{\circ}C$		0.01		
POK Threshold		$V_{OUT}$ when POK switches	$V_{OUT}$ rising	88	91	94	%
			$V_{OUT}$ falling		88		
POK Voltage, Low	$V_{OL}$	$I_{POK} = 1mA$			10	100	mV
POK Leakage Current	$I_{POK\_LK}$	$V_{POK} = 5.5V$	$T_A = +25^{\circ}C$	-1	+0.001	+1	$\mu A$
			$T_J = +125^{\circ}C$		0.01		
IN Reverse-Current Threshold		$V_{OUT} = 1.2V$ , $V_{BIAS} = 10V$			700		mA
Thermal Shutdown Threshold		$T_J$ when output turns on/off	$T_J$ rising		165		$^{\circ}C$
			$T_J$ falling		150		

**Note 1:** Limits over the specified operating temperature and supply voltage range are guaranteed by design and characterization, and production tested at room temperature only.

**Note 2:** Dropout voltage is defined as ( $V_{IN} - V_{OUT}$ ) when  $V_{OUT}$  is 95% of its nominal value.



Typical Operating Characteristics

( $V_{IN} = 1.5V$ ,  $V_{BIAS} = 12V$ ,  $V_{OUT} = 1.0V$ ,  $C_{IN} = 22\mu F$ ,  $C_{OUT} = 22\mu F$ ,  $C_{BYP} = 47nF$ ,  $C_{BIAS} = 1\mu F$ ,  $T_A = +25^\circ C$ , unless otherwise noted)

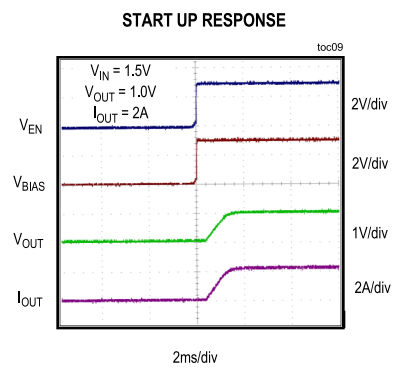
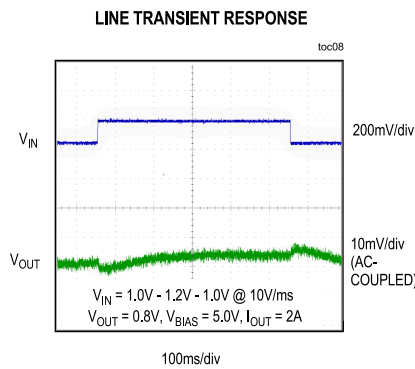
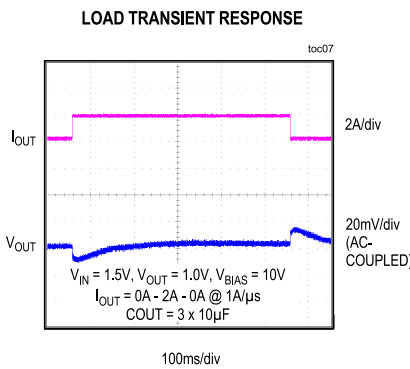
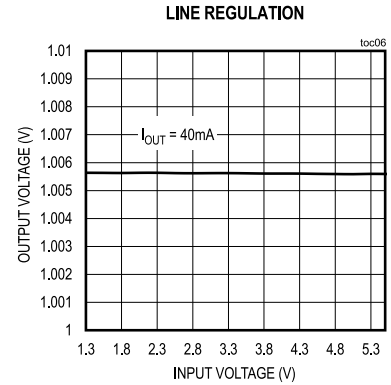
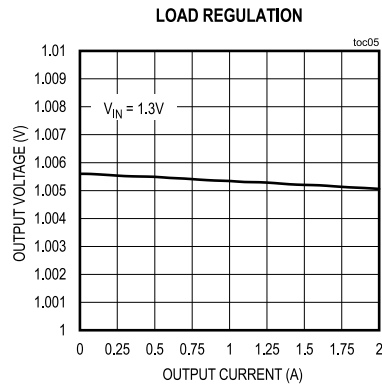
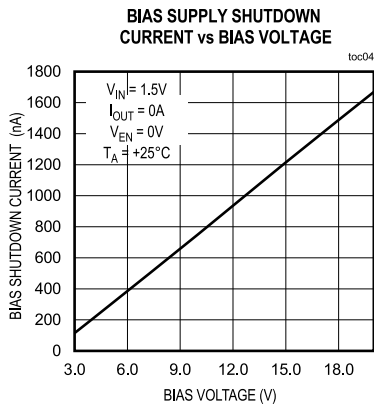
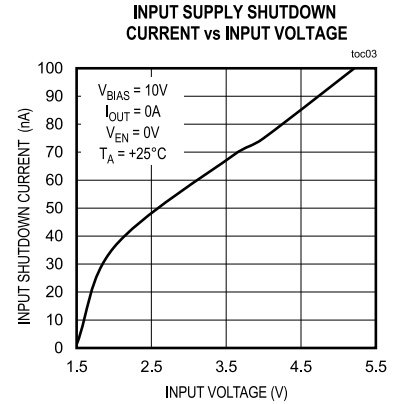
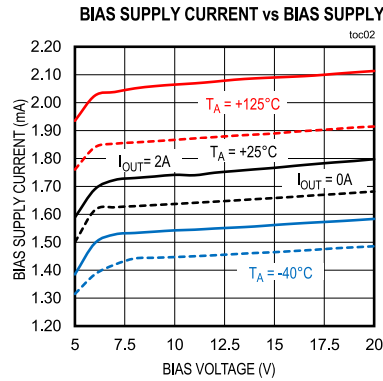
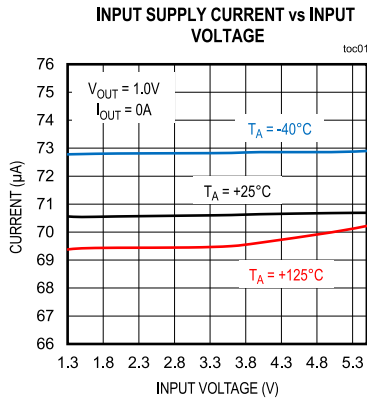

Typical Operating Characteristics (continued)

( $V_{IN} = 1.5V$ ,  $V_{BIAS} = 12V$ ,  $V_{OUT} = 1.0V$ ,  $C_{IN} = 22\mu F$ ,  $C_{OUT} = 22\mu F$ ,  $C_{BYP} = 47nF$ ,  $C_{BIAS} = 1\mu F$ ,  $T_A = +25^\circ C$ , unless otherwise noted)

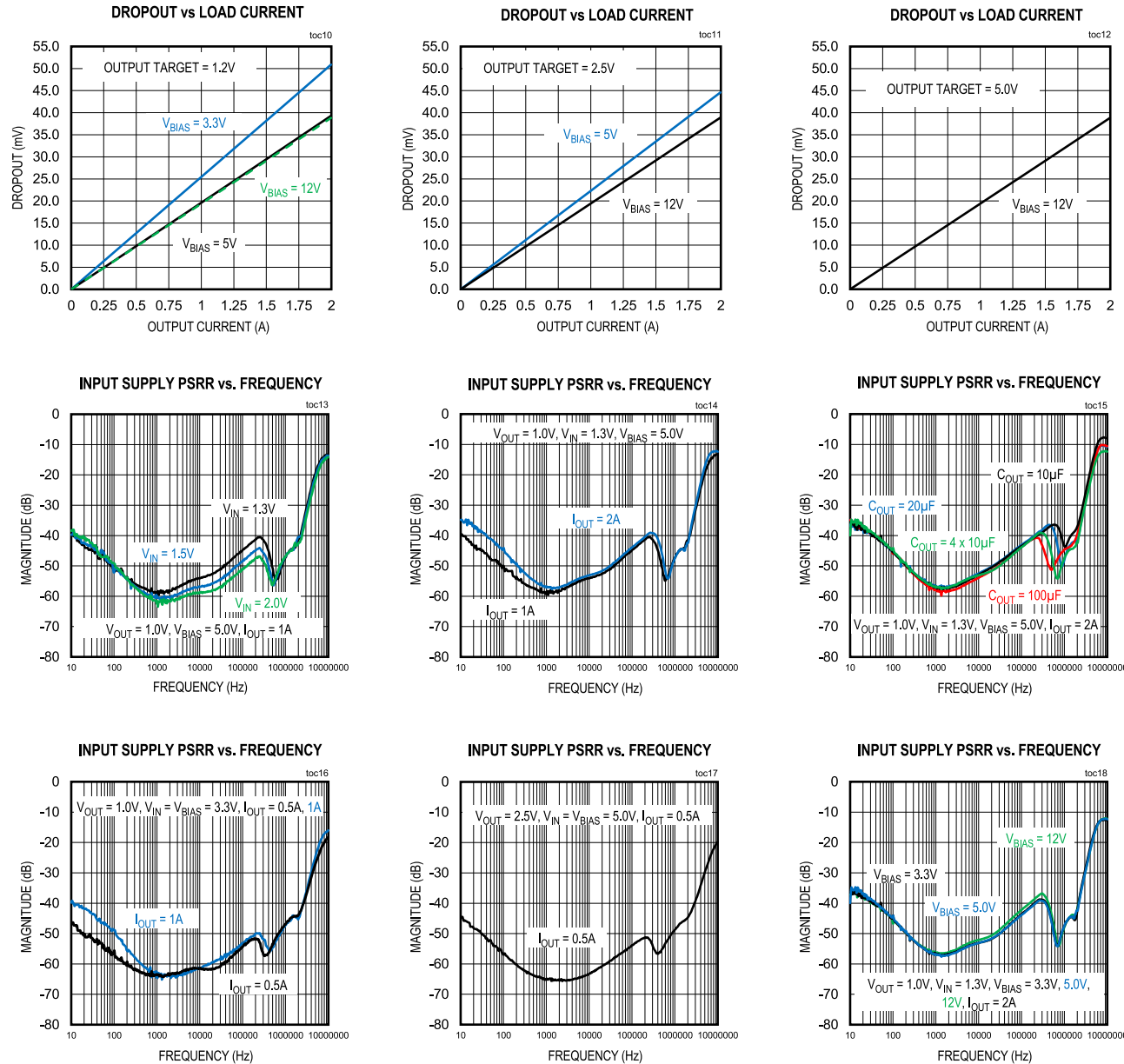

Typical Operating Characteristics (continued)

( $V_{IN} = 1.5V$ ,  $V_{BIAS} = 12V$ ,  $V_{OUT} = 1.0V$ ,  $C_{IN} = 22\mu F$ ,  $C_{OUT} = 22\mu F$ ,  $C_{BYP} = 47nF$ ,  $C_{BIAS} = 1\mu F$ ,  $T_A = +25^\circ C$ , unless otherwise noted)

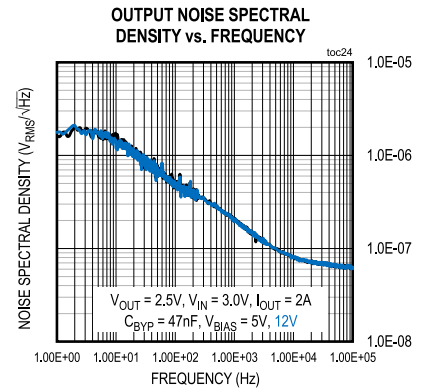
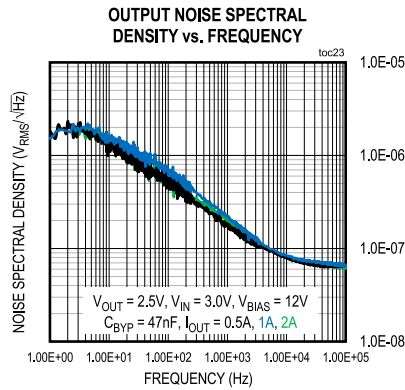
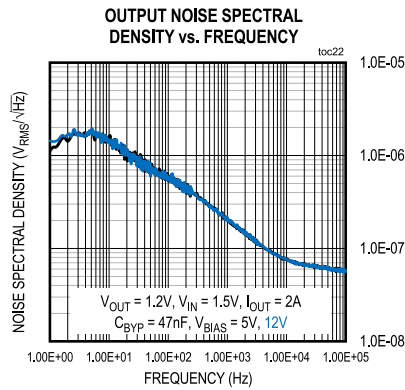
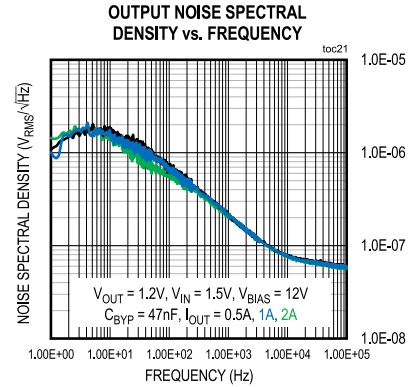
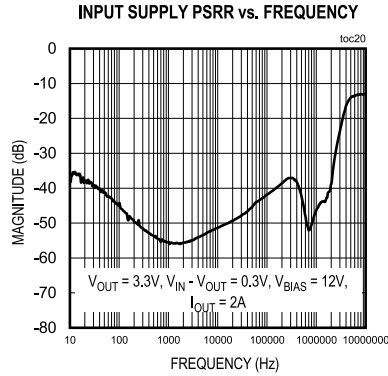
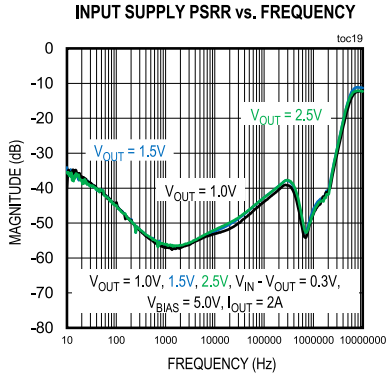

ENABLE PIN BIAS CURRENT vs TEMPERATURE

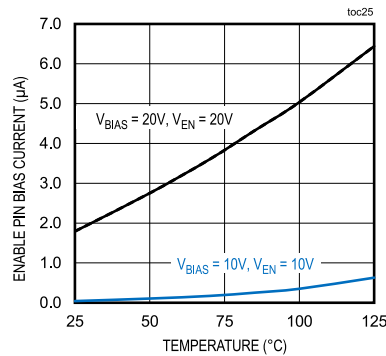

Pin Configurations

14 TDFN

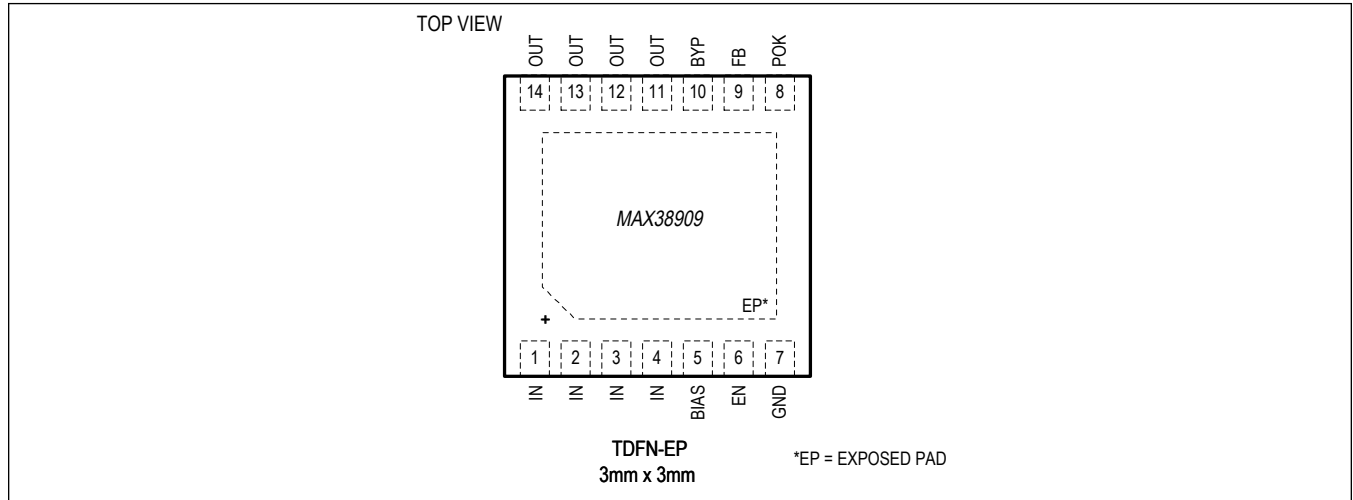

WLP

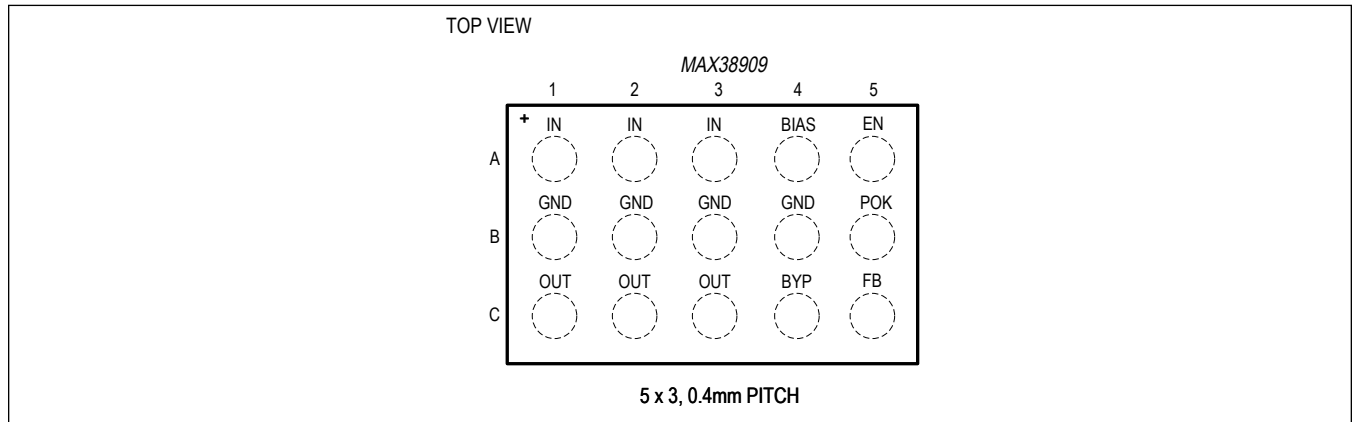

Pin Description

PIN		NAME	FUNCTION
14 TDFN	WLP		
1–4	A1–A3	IN	Regulator Supply Input. Connect to a voltage between 0.9V and 5.5V and bypass with a 22µF ceramic capacitor from IN to GND.
5	A4	BIAS	Bias Supply Input. Connect to a voltage between 2.7V and 20V and bypass with a 1µF capacitor from BIAS to GND. BIAS must be 2.0V or more above the V <sub>OUT</sub> target.
6	A5	EN	Enable. Connect this pin to a logic signal to enable (V <sub>EN</sub> high) or disable (V <sub>EN</sub> low) the regulator output. Connect to BIAS to keep the output enabled whenever a valid supply voltage is present.
7	B1–B4	GND	Regulator Ground. Bring IN and OUT bypass capacitor GND connections to this pin for best performance.

Pin Description (continued)

PIN		NAME	FUNCTION
14 TDFN	WLP		
8	B5	POK	Power-On Reset Output. Connect a pullup resistor from this pin to a supply to create a reset signal that goes high after the regulator output has reached its regulation target voltage.
9	C5	FB	Output Voltage Feedback Input. Connect resistor divider across OUT and GND with the center connected to this pin to set any output voltage between 0.6V and 5.0V.
10	C4	BYP	Bypass Capacitor Input. Connect a 0.001 $\mu$ F to 0.1 $\mu$ F capacitor between OUT and BYP to reduce output noise.
11–14	C1–C3	OUT	Regulator Output. Sources up to 2A at the output regulation voltage. Bypass this pin with 22 $\mu$ F ceramic capacitor to GND. It is pulled low with a 70 $\Omega$ resistance when the regulator is disabled.
—	—	EP	Exposed Pad (TDFN Only). Connect the exposed pad to a ground plane with low thermal resistance to ambient to provide best heat sinking.

Functional Diagram

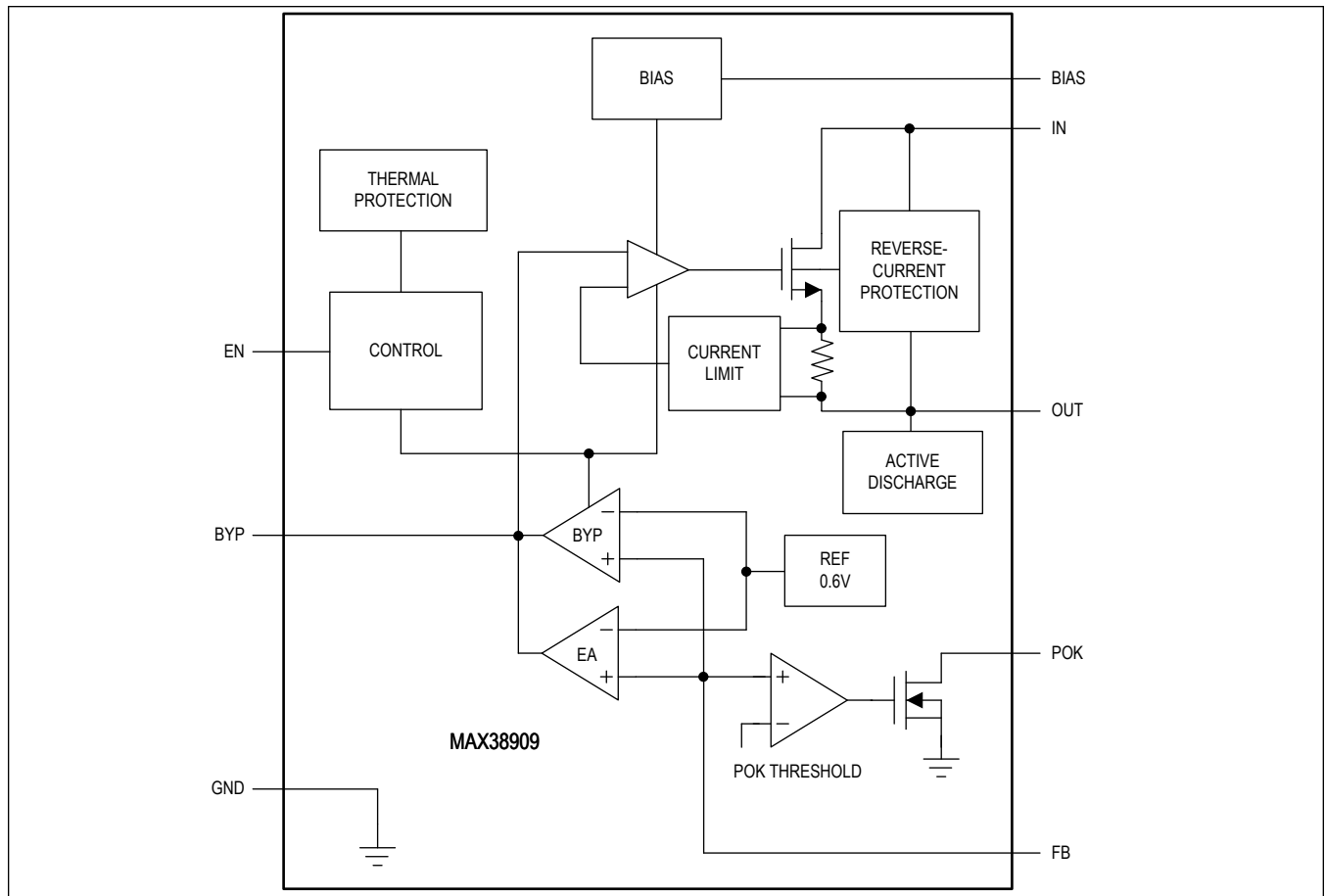

## Detailed Description

The MAX38909 is a fast transient, high PSRR linear regulator that delivers up to 2A of load current. The regulator supports a wide input supply (0.9V to 5.5V) and BIAS (2.7V to 20V) voltage ranges, making it suitable for variety of applications. The output voltage regulation accuracy of  $\pm 1\%$  is maintained across load, line, and temperature variations, requiring only 300mV of input-to-output headroom at full load for good PSRR. The output voltage can be adjusted to accommodate customers that desire to specify a single LDO in the BOM for multiple voltage rails.

The output voltage is programmed to a value in the range of 0.6V to 5.0V by using two external feedback resistors. The LDO is fully protected from damage by internal circuitry that provides programmable inrush current limiting, output overcurrent limiting, reverse current-limiting, and thermal overload protection.

### Enable

The MAX38909 includes an enable pin (EN). The enable signal is an active-high digital signal that enables the device when its voltage passes the rising threshold ( $V_{EN} \geq V_{IH}(EN)$ ) and disables the device when its voltage is below the falling threshold ( $V_{EN} \leq V_{IL}(EN)$ ). While in the shutdown ( $V_{EN} = 0V$ ), the MAX38909 consumes 1nA of current from the input supply. If a separate shutdown signal is not available, connect EN to BIAS. When EN is driven by a host its bias current will vary with the BIAS supply level. See the Typical Operating Characteristics for more information.

### Bypass

The capacitor connected from BYP to OUT filters noise at the reference, feedback resistors and regulator input stage. It provides a high-speed feedback path for improved transient response. A 10nF capacitor rolls off noise at around 32Hz.

The slew rate of the output voltage during startup is also determined by the BYP capacitor. The MAX38909 features programmable, monotonic, soft-start set by this capacitor. Its use is highly recommended to minimize inrush current into the output capacitor. A 10nF capacitor sets the slew rate to 5V/ms. This startup rate results in a 110mA slew current drawn from the input at startup to charge 22 $\mu$ F output capacitance.

The BYP capacitor value can be adjusted from 1nF to 100nF to change the startup slew rate according to the following formula:

$$\text{Startup slew rate} = 5V/ms \times 10nF/C_{BYP}$$

where  $C_{BYP}$  is in nF.

This slew rate applies until  $V_{OUT}$  reaches 75% of the target after which the  $V_{OUT}$  slew rate is reduced.

Also, note that being a low-frequency filter node, BYP is sensitive to leakage. BYP leakage currents above 10nA cause measurable inaccuracy at the output and should be avoided.

### Power OK

The power-OK (POK) function monitors the voltage at the feedback pin to indicate the output voltage is in regulation. Its operation versus the output voltage is shown in [Figure 1](#).

The POK pin is open-drain and requires a pullup resistor to an external supply to properly report the device regulation status to other devices so it can be used for sequencing. Check if the external pullup supply voltage results in a valid logic levels for the receiving device or devices.

The range of the pullup resistance is between 10k $\Omega$  and 100k $\Omega$ . Its lower limit comes from a pulldown strength of the POK transistor while the higher limit is determined by maximum leakage current at the POK pin.

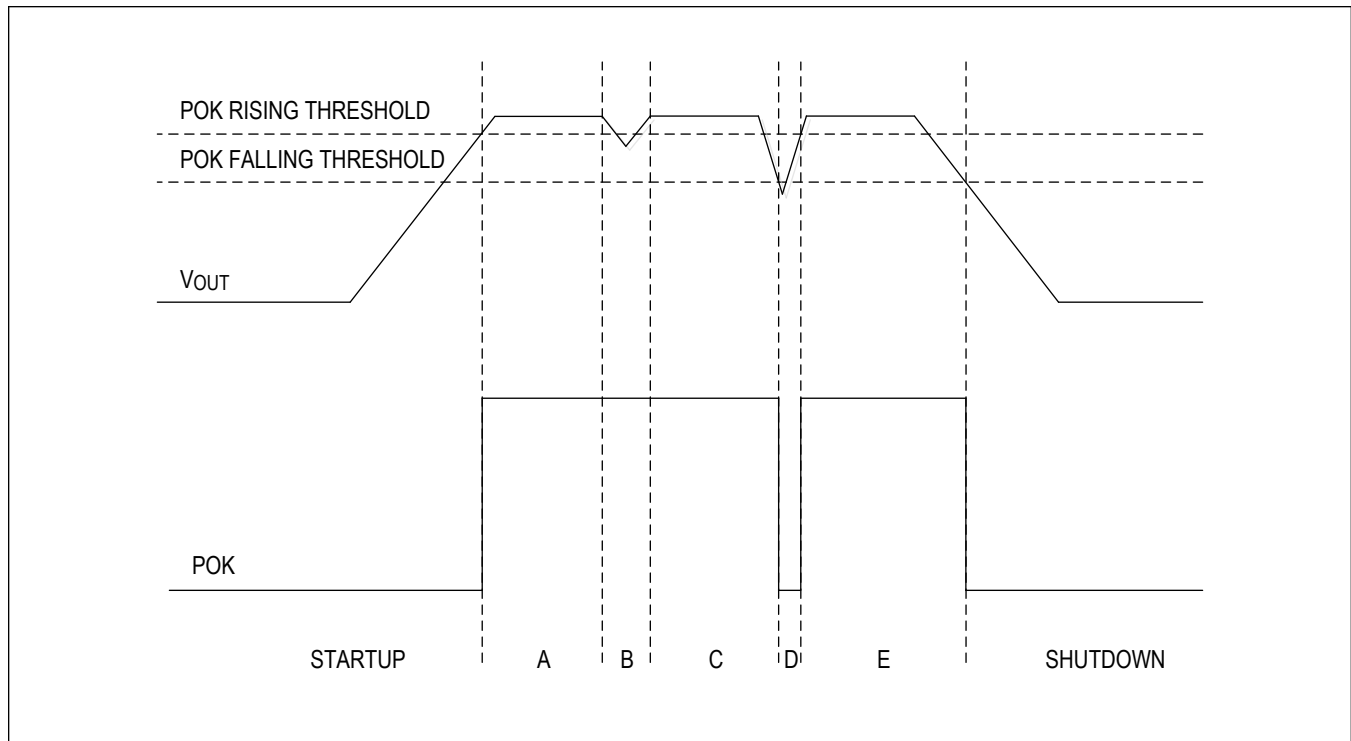

Figure 1. Typical POK Operation

The POK operation versus the output voltage is shown in the [Figure 1](#) above. Different operating regions are:

- A:** The device is in regulation.
- B:**  $V_{OUT}$  sags, but does not reach the POK falling threshold.
- C:** The device is in regulation.
- D:**  $V_{OUT}$  sags low enough to cross the POK falling threshold. The POK is driven low until  $V_{OUT}$  recovers above the POK rising threshold.
- E:** The device is in regulation.

### Protection

The MAX38909 is fully protected from an output short-circuit by a current-limiting and thermal overload protection circuit. If the output is shorted to GND, the output current is limited to 2.8A (typ). Under these conditions, the device quickly heats up. When the junction temperature reaches +165°C, a thermal limit circuit shuts the output device off. Once the device cools to 150°C, the output turns back on to reestablish regulation. If the fault persists, the output current cycles on and off as the junction temperature slews between +150°C and +165°C. Continuously operating in the fault conditions or above +125°C junction temperature is not recommended since long-term reliability might be reduced. In dropout, the current limit triggers at 4A (typ). Once the limit is triggered, the device limits the current to 2.8A (typ).

The thermal protection can also be triggered when the device is exposed to excessive heat in the system causing the die temperature to reach undesired levels.

The MAX38909 provides the reverse-current protection when the output voltage is higher than the input. If extra output capacitance is used at the output, a power-down transient at the input would normally cause a large reverse-current through a conventional regulator. The MAX38909 include a reverse-voltage detector that trips when  $I_N$  drops 6.5mV below  $I_{OUT}$  shutting off the regulator and opening the body diode connection preventing any reverse current. The reverse current is a current that flows through the body diode of the pass element and is undesired due to its impact on power

dissipation and long-term reliability especially at higher current levels. The conditions where the reverse current can be flowing back to IN are:

- If the device has a large  $C_{OUT}$  and the input supply collapses quickly; OUT has little or no-load current,
- The output is biased when the input supply is not established, or
- The output is biased above the input supply.

The MAX38909 blocks reverse currents that exceed about 0.7A by opening a switch in series with the pass device body diode.

### Undervoltage Lockout (UVLO)

The MAX38909 undervoltage lockout (UVLO) circuits respond quickly to glitches on IN or BIAS and attempts to disable the output of the device if either of these rails collapse. The local input capacitance prevents transient brownouts in most applications.

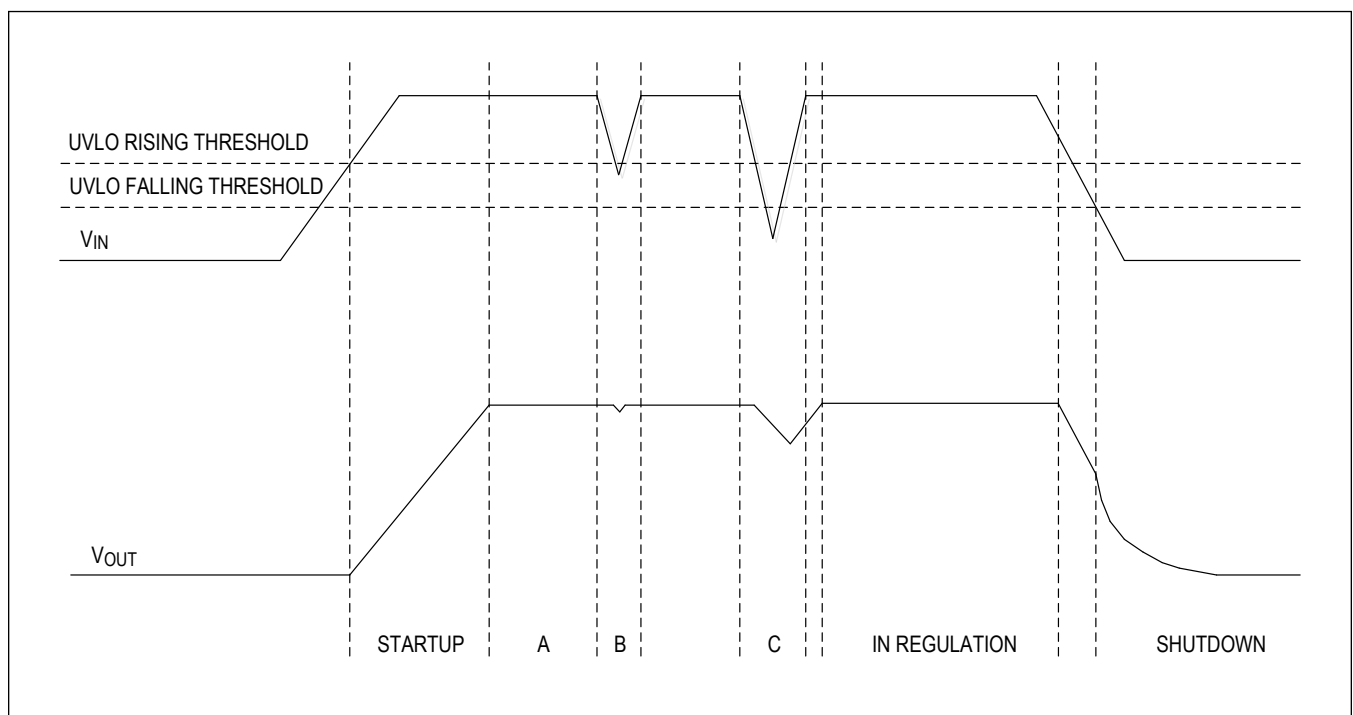

Figure 2. Typical IN UVLO Operation

The [Figure 2](#) above reflects UVLO operation. The different operation regions are:

**STARTUP:** The device begins the soft-start once the input voltage crosses its UVLO rising threshold providing the BIAS voltage is already above its UVLO rising threshold and the device is enabled ( $V_{EN} > V_{IH}$ ).

**A:** The device is in regulation.

**B:** An input supply brownout condition where  $V_{IN}$  can sag below UVLO rising threshold but not below the falling threshold. The device is enabled. Note the output sags once the device is in dropout.

**C:** An input supply brownout condition where  $V_{IN}$  sags below UVLO falling threshold. The device is disabled when  $V_{IN}$  crosses its UVLO falling threshold.  $V_{OUT}$  drops due to load current. The regulator gets enabled again once  $V_{IN}$  recovers to the UVLO rising threshold. Note the output starts to sag once the device is in dropout.

**SHUTDOWN:** The output voltage starts to ramp down once the device gets into dropout. It is disabled when the input



voltage drops below its UVLO falling threshold.

During  $V_{IN}$  power-up, the MAX38909 begins  $V_{OUT}$  soft-start after  $V_{IN}$  crosses the  $V_{IN}$  UVLO rising threshold. This assures proper  $V_{OUT}$  ramp up and transition to regulation.  $V_{OUT}$  soft-start rate should be kept as or slower than the  $V_{IN}$  slew rate to avoid entering the dropout. In some situations,  $V_{IN}$  transients can place the regulator into dropout. As  $V_{IN}$  starts climbing again and the device comes out of the dropout, the output can overshoot, as shown in [Figure 3](#). This condition is avoided by using an enable signal or by increasing the soft-start time with larger  $C_{BYP}$ .

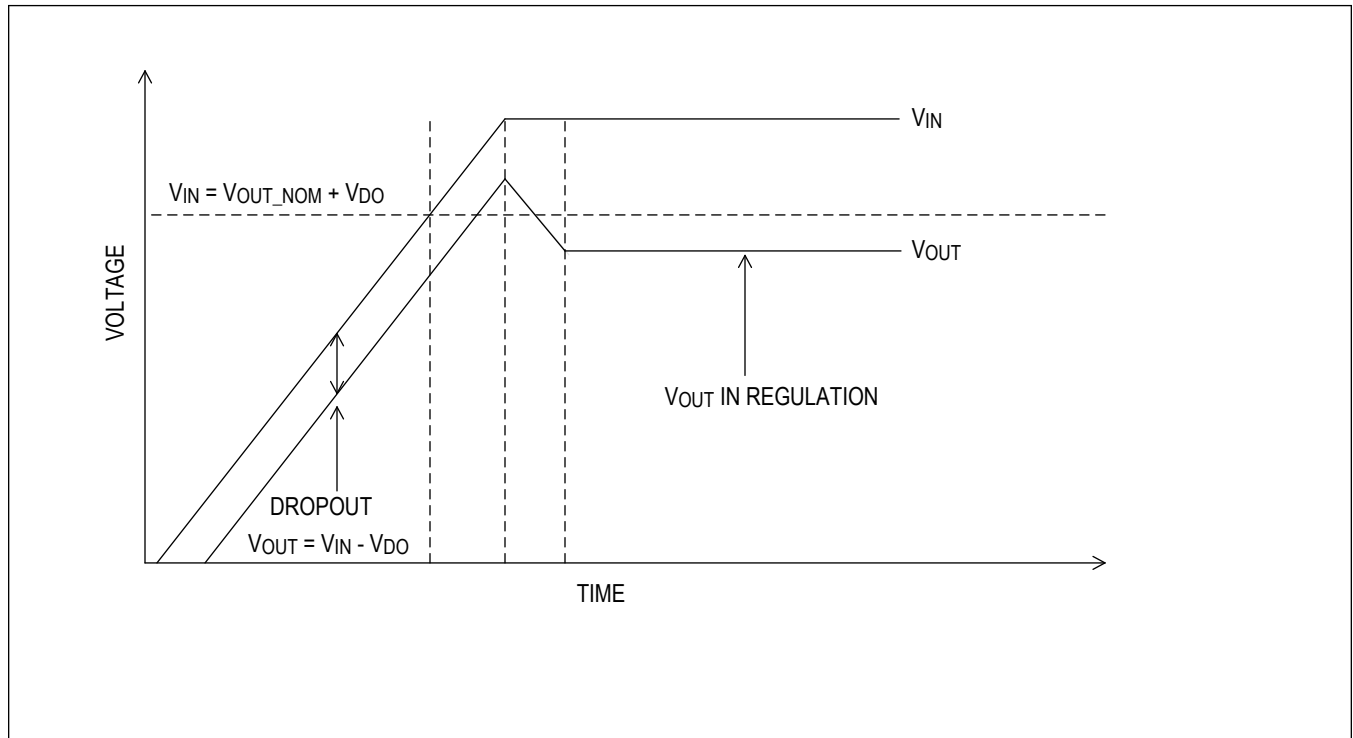

Figure 3. Startup into Dropout

### Active Discharge

When EN is low or BIAS supply is below its falling UVLO threshold, the MAX38909 connects a  $70\Omega$  resistor from  $V_{OUT}$  to GND in order to discharge the output capacitance.

### Voltage Selection

The MAX38909 use external feedback resistors to set the output regulation voltage. The output voltage can be set from 0.6V to 5.0V. Set the bottom feedback resistor  $R_1$  to less than  $100k\Omega$  to minimize FB input bias current error. Calculate the value of the top feedback resistor  $R_2$  as follows:

$$R_2 = R_1 \times (V_{OUT}/V_{FB} - 1)$$

where  $V_{FB}$  is the feedback regulation voltage of 0.6V.

To set the output to 1.0V, for example,  $R_2$  should be:

$$R_2 = 15k\Omega \times (1.0V/0.6V - 1) = 10k\Omega$$

$R_1$  of  $15k\Omega$  is recommended to optimize noise performance.

Values of the resistor divider and its tolerance will have a direct impact to  $V_{OUT}$  accuracy. 1% resistors or better are recommended. [Table 1](#) shows recommended values for the feedback resistors.

**Table 1. Recommended Feedback Resistor Values**

TARGETED OUTPUT VOLTAGE (V)	TOP FEEDBACK RESISTOR VALUES (k $\Omega$ )	BOTTOM FEEDBACK RESISTOR VALUES (k $\Omega$ )	CALCULATED OUTPUT VOLTAGE (V)
0.8	4.99	15.0	0.799
0.9	7.50	15.0	0.900
1.0	10.0	15.0	1.0
1.2	15.0	15.0	1.2
1.5	22.6	15.0	1.504
1.8	30.1	15.0	1.804
2.5	47.5	15.0	2.5
2.7	52.3	15.0	2.692
3.0	59.0	14.7	3.008
3.3	68.1	15.0	3.324
3.6	75.0	15.0	3.6
4.5	97.6	15.0	4.504
5.0	110.0	15.0	5.0

## Applications Information

### Input and Output Capacitors

The MAX38909 is designed to have stable operation using low equivalent series resistance (ESR) ceramic capacitors at the input, output, and bypass pin. Multilayer ceramic capacitors (MLCC) with X7R dielectric are commonly used for these types of applications and are recommended due to their relatively stable capacitance across temperature. Nevertheless, amount of equivalent capacitance depends on operating DC voltage, AC voltage ripple, temperature, etc. Therefore, the capacitor data sheet needs to be properly examined.

The MAX38909 is designed and characterized for operation with X7R ceramic capacitors of 22 $\mu$ F or greater (10 $\mu$ F or greater of effective capacitance) both at the input and output. Place these capacitors as close as possible to the respective input and output pins to minimize trace parasitics.

A combination of multiple output capacitors in parallel boosts the high-frequency PSRR.

### Thermal Design

To optimize the MAX38909 performance, special consideration is given to the device power dissipation and PCB thermal design. Power dissipation in the regulator depends on the input-to-output voltage difference and load conditions. It can be calculated by following equation:

$$\text{Loss (W)} = (V_{\text{IN}} - V_{\text{OUT}}) \times I_{\text{LOAD}}$$

The optimal power dissipation can be achieved by carefully choosing input voltage for a given output target rail voltage.

The main thermal conduction path for the device is through the exposed pad of the package. As a result, the thermal pad must be soldered to a copper pad area under the device. Thermal plated vias must be placed inside the thermal PCB pad to transfer heat to different GND layers in the system. The vias should be capped to minimize solder voids. The maximum power dissipation is determined by using thermal resistance from the device junction to ambient keeping the maximum junction temperature below +125°C. Thermal properties of the package are given in the [Package Information](#) section.

The first order power dissipation estimate for the 3.3V IN and 2.5V OUT with load current of 500mA condition is:

$$\text{Loss (W)} = (V_{\text{IN}} - V_{\text{OUT}}) \times I_{\text{LOAD}} = (3.3\text{V} - 2.5\text{V}) \times 0.5\text{A} = 0.4\text{W}$$

Assuming the MAX38909ATD+ is used, this power dissipation raises the junction temperature to:

$$T_{\text{J}} = (\text{PD} \times \theta_{\text{JA}}) + 25^{\circ}\text{C} = (0.4\text{W} \times 41^{\circ}\text{C}/\text{W}) + 25^{\circ}\text{C} = 41.4^{\circ}\text{C}$$

## Ordering Information

PART NUMBER	TEMPERATURE RANGE	PIN-PACKAGE	FEATURE
MAX38909ATD+	-40°C to +125°C	14 TDFN, 3mm x 3mm	2A LDO, enable input, externally adjustable output, low noise bypass
MAX38909ANL+	-40°C to +125°C	15 WLP, 5 x 3, 0.4mm pitch	2A LDO, enable input, externally adjustable output, low noise bypass

+Denotes a lead(Pb)-free/RoHS-compliant package.

**Revision History**

REVISION NUMBER	REVISION DATE	DESCRIPTION	PAGES CHANGED
0	11/20	Release for market intro	—
1	11/20	Updated <i>Ordering Information</i> table	19

For pricing, delivery, and ordering information, please visit Maxim Integrated's online storefront at <https://www.maximintegrated.com/en/storefront/storefront.html>.

*Maxim Integrated cannot assume responsibility for use of any circuitry other than circuitry entirely embodied in a Maxim Integrated product. No circuit patent licenses are implied. Maxim Integrated reserves the right to change the circuitry and specifications without notice at any time. The parametric values (min and max limits) shown in the Electrical Characteristics table are guaranteed. Other parametric values quoted in this data sheet are provided for guidance.*