



MAX8723 Evaluation Kit

Evaluates: MAX8723

General Description

The MAX8723 evaluation kit (EV kit) is a fully assembled and tested surface-mount circuit board that contains a pulse-width-modulated (PWM) step-down DC-DC converter. The EV kit is configured to operate with a 1.5MHz switching frequency. It operates from a +6V to +13.2V DC supply voltage, is configured for a +3.3V output, and can provide up to 2A output current.

The MAX8723 EV kit can be reconfigured to operate at 500kHz or 1MHz and can also drive an external synchronous rectifier. In addition, the output voltage can be adjusted from 2.0V to 3.6V by installing appropriate feedback resistors R4 and R5.

The EV kit is a fully assembled and tested circuit board that features low quiescent current and high conversion efficiency (84%). Operation at 1.5MHz allows the use of small surface-mount components.

Features

- ◆ +6V to +13.2V Input Range
- ◆ 2A Output Current
- ◆ 1.5MHz Switching Frequency (Selectable: 500kHz, 1MHz, Component Changes Required)
- ◆ +3.3V Output Voltage (Fixed Mode)
- ◆ 2.0V to 3.6V Output Voltage (Adjustable Mode)
- ◆ 84% Efficiency
- ◆ Fully Assembled and Tested

Ordering Information

PART	TEMP RANGE	IC PACKAGE
MAX8723EVKIT	0°C to +70°C	16 TQFN (4mm x 4mm)

Component List

DESIGNATION	QTY	DESCRIPTION
C1	1	4.7μF ±10%, 16V X5R ceramic capacitor (0805) TDK C2012X5R1C475K
C2	1	0.1μF ±10%, 25V X7R ceramic capacitor (0603) TDK C1608X7R1E104K
C3	1	1μF ±10%, 10V X5R ceramic capacitor (0603) TDK C1608X5R1A105K
C4	1	0.22μF ±10%, 10V X5R ceramic capacitor (0603) TDK C1608X5R1A224K
C5	1	0.1μF ±10%, 50V X7R ceramic capacitor (0603) TDK C1608X7R1H104K
C6	1	22μF ±20%, 6.3V X7R ceramic capacitor (0805) TDK C2012X5R0J226M
C7	1	47μF ±20%, 25V aluminum electrolytic capacitor (6.3mm x 6.0mm) Sanyo 25CV470AX

DESIGNATION	QTY	DESCRIPTION
C8	0	Not installed, ceramic capacitor (1206)
C9	0	Not installed, ceramic capacitor (0805)
D1	1	3A, 30V Schottky diode (M-flat) Toshiba CMS03
JU1	1	2-pin header
JU2	0	Not installed, 4-pin header
L1	1	2.2μH power inductor Sumida CDRH5D18NP-2R2NC
R1, R6	2	0Ω ±5% resistors (0603)
R2	0	Not installed, short by PC trace (0603)
R3	1	100kΩ ±5% resistor (0603)
R4	0	Not installed, resistor (0805)
R5	1	0Ω ±5% resistor (0805)
Q1	0	Not installed, n-channel MOSFET (SOT23)
U1	1	MAX8723ETE+ (16-pin TQFN 4mm x 4mm)
—	1	Shunt
—	1	MAX8723 EV kit PC board

Component Suppliers

SUPPLIER	PHONE	WEBSITE
International Rectifier	310-322-3331	www.irf.com
Sanyo	619-661-6835	www.sanyodevice.com
Sumida	847-545-6700	www.sumida.com
TDK	847-803-6100	www.component.tdk.com
Toshiba	949-455-2000	www.toshiba.com/taec

Note: Indicate that you are using the MAX8723 when contacting these suppliers.



Maxim Integrated Products 1

For pricing, delivery, and ordering information, please contact Maxim/Dallas Direct! at 1-888-629-4642, or visit Maxim's website at www.maxim-ic.com.

MAX8723 Evaluation Kit

Recommended Equipment

- 12V, 2A DC power supply
- Voltmeters

Quick Start

The MAX8723 EV kit is fully assembled and tested. Follow these steps to verify board operation. **Do not turn on the power supply until all connections are completed:**

- 1) Verify that there is no shunt across jumper JU1 to enable the MAX8723.
- 2) Set the DC power supply to +12V.
- 3) Connect the positive terminal of the DC power supply to the VIN pad. Connect the negative terminal of the DC power supply to the PGND pad closest to VIN.
- 4) Connect a voltmeter across the VOUT and PGND pads.
- 5) Turn on the power supply and verify that the output (VOUT) is +3.3V.

Detailed Description

The MAX8723 EV kit contains a high-efficiency, PWM, step-down switching regulator. The EV kit operates from a +6V to +13.2V DC power supply, is configured for a +3.3V output, and is capable of providing a 2A load current. The regulator's switching frequency is set to 1.5MHz. See the *Switching-Frequency Selection (FREQ)* section for operation at other frequencies.

The EV kit can be operated with a fixed-mode (+3.3V) or adjustable-mode (2.0V to 3.6V) output. When operating in adjustable mode, the EV kit output is set by installing appropriate feedback resistors, R4 and R5. For details on changing the feedback resistors see the *Evaluating Other Output Voltages* section.

The EV kit provides shutdown capability through jumper JU1. The use of an external synchronous rectifier, Q1, is also supported. See the *External Synchronous Rectifier* section.

Jumper Selection

Shutdown Mode (SHDN)

The EV kit features a shutdown mode that reduces the MAX8723 quiescent current. JU1 selects the shutdown mode. See Table 1 for jumper JU1 functions.

Table 1. Jumper JU1 Functions

SHUNT LOCATION	SHDN PIN	MAX8723 OUTPUT
Installed	Connected to GND	Shutdown mode, VOUT = 0V
Not installed (default)	Connected to VCC through R3	MAX8723 enabled, VOUT = +3.3V

Switching-Frequency Selection (FREQ)

The MAX8723 EV kit provides the option to configure the switching frequency of the step-down DC-DC converter. Table 2 lists jumper JU2 settings for configuring the switching frequency. The EV kit is configured and shipped to operate at 1.5MHz. For operation at 500kHz or 1MHz, cut the trace between pins 1 and 2 of jumper JU2 and short pins 1 and 3 or 1 and 4, respectively. Changing the switching frequency may require different converter components. Refer to the MAX8723 data sheet for proper component selection.

Table 2. Jumper JU2 Functions

SHUNT LOCATION	FREQ PIN	SWITCHING FREQUENCY
1-2 (default)	Connected to GND with a PC trace	1.5MHz
1-3	Connected* to VREF	500kHz
1-4	Connected* to VCC	1MHz

*Cut the trace between pins 1-2 before shorting pins 1-3 or 1-4.

Evaluating Other Output Voltages

As configured, the MAX8723 EV kit operates in fixed-output mode, providing a +3.3V output. To adjust the EV kit output voltage (2.0V to 3.6V) choose appropriate R4 and R5 resistance values. See Table 3 for details on selecting appropriate feedback resistors.

Table 3. Output-Voltage Modes

OUTPUT MODE	FEEDBACK RESISTORS	OUTPUT VOLTAGE
Fixed	R4 = open R5 = 0Ω	+3.3V
Adjustable	$R4 = R5 \times \left[\left(\frac{V_{OUT}}{V_{FB}} \right) - 1 \right]$ R5 = 10kΩ to 50kΩ V _{FB} = 2.0V	$V_{OUT} = V_{FB} \times \left[1 + \left(\frac{R4}{R5} \right) \right]$ (2.0V to 3.6V)

MAX8723 Evaluation Kit

Evaluates: MAX8723

External Synchronous Rectifier

The EV kit provides for the use of an external synchronous rectifier. To utilize an external synchronous rectifier, install an adequate n-channel MOSFET (Q1) and remove or replace diode D1. Installing a smaller diode in conjunction with the synchronous rectifier improves efficiency. Leaving the diode unpopulated reduces cost. See Table 4 for recommended components.

Table 4. Recommended Configurations

Q1	D1	EFFICIENCY (%) ($V_{IN} = 12V$, $I_{OUT} = 2A$ AT 1.5MHz)
Not installed (default)	3A, 30V Schottky diode (M-flat) Toshiba CMS03	83
3A, 20V n-channel MOSFET (Supersot-3) Fairchild FDN339AN	Not installed	84
	500mA, 30V Schottky diode (SOD123) International Rectifier MBR0530	85

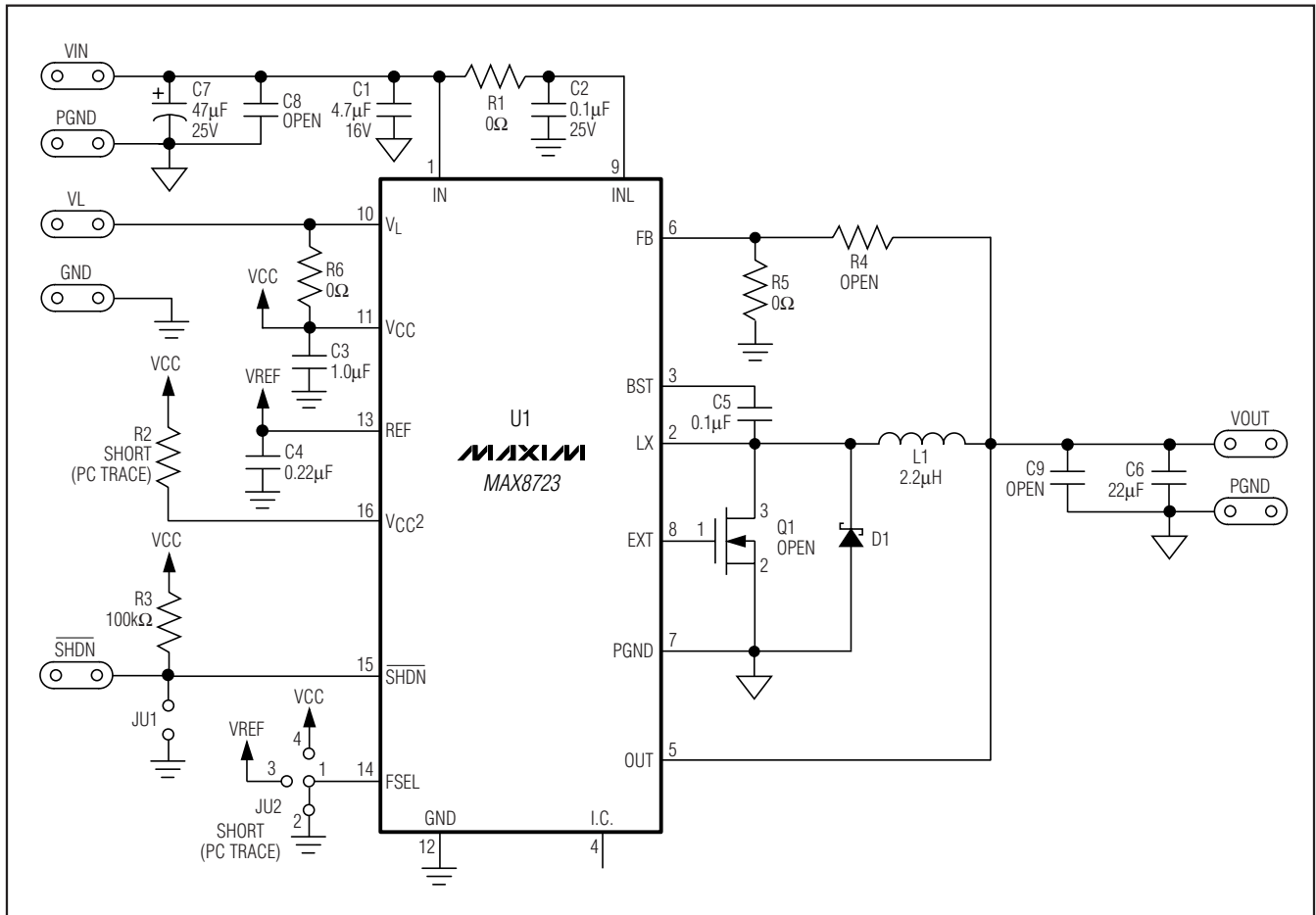

Figure 1. MAX8723 EV Kit Schematic

MAX8723 Evaluation Kit

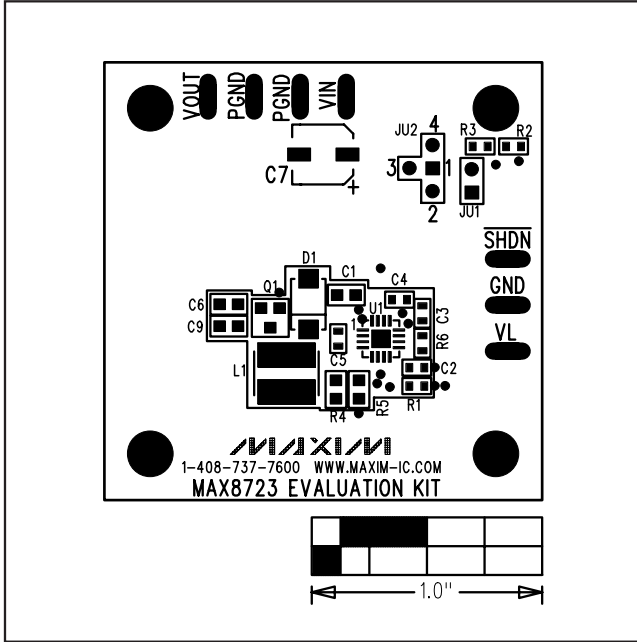

Figure 2. MAX8723 EV Kit Component Placement Guide—Component Side

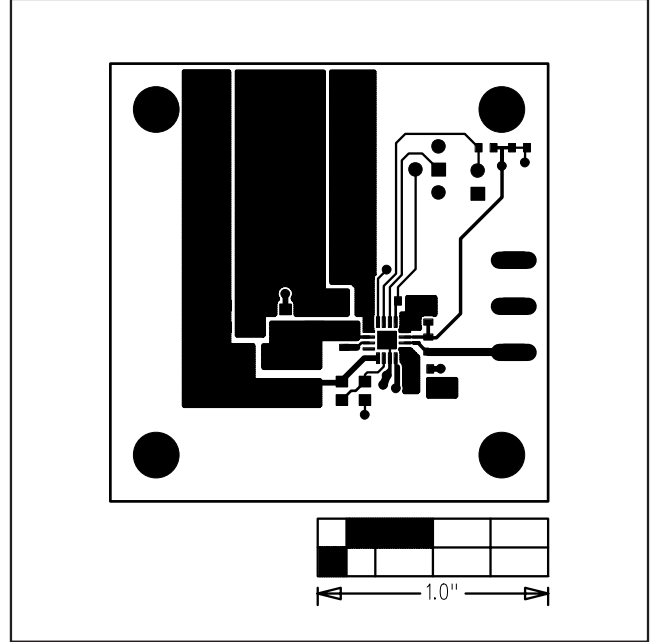

Figure 3. MAX8723 EV Kit PC Board Layout—Component Side

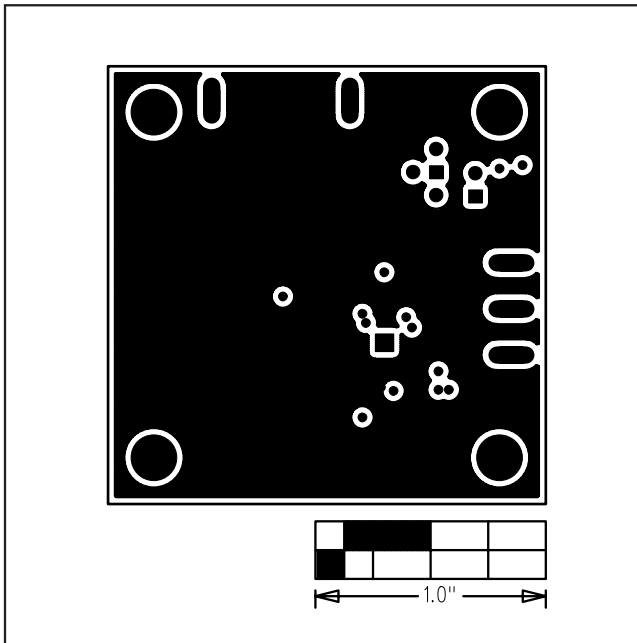

Figure 4. MAX8723 EV Kit PC Board Layout—Internal Layer 2, GND Plane

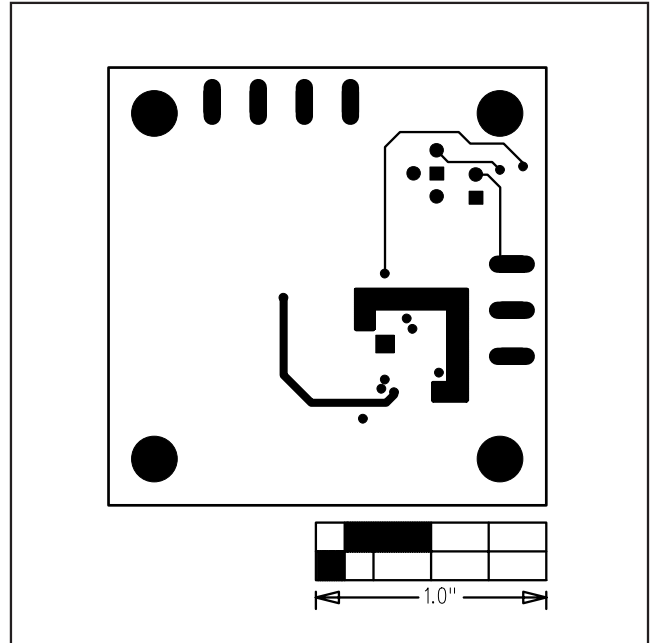

Figure 5. MAX8723 EV Kit PC Board Layout—Internal Layer 3, Power Plane

MAX8723 Evaluation Kit

Evaluates: MAX8723

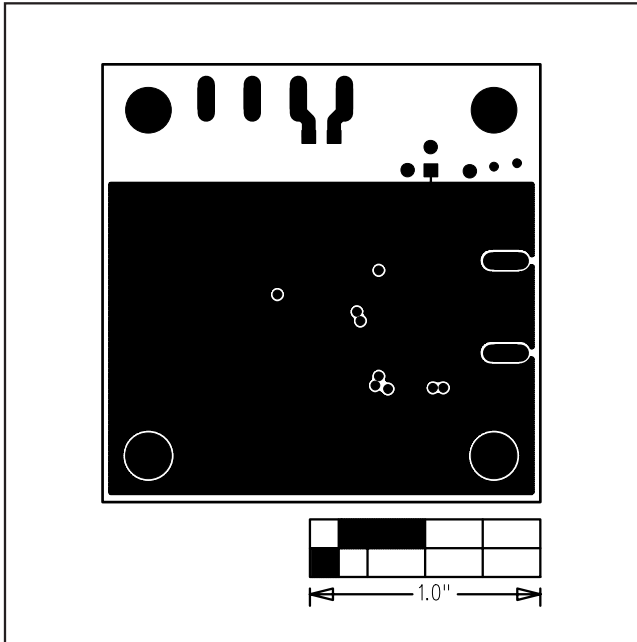

Figure 6. MAX8723 EV Kit PC Board Layout—Solder Side

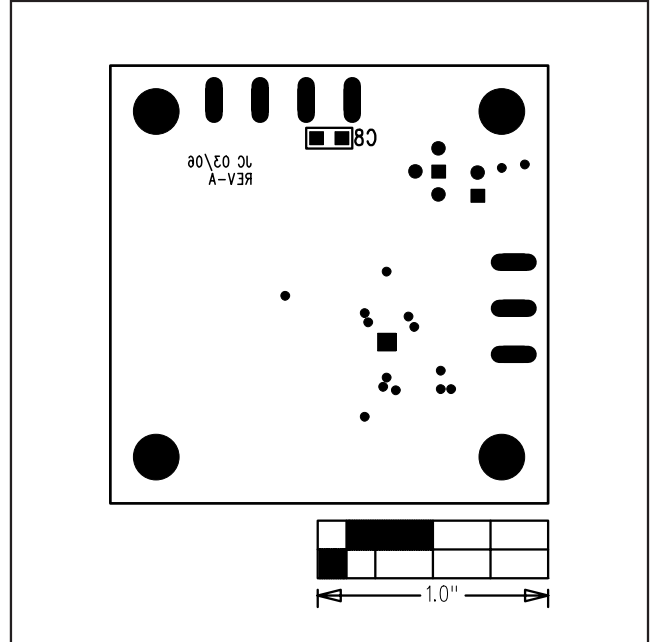

Figure 7. MAX8723 EV Kit Component Placement Guide—Solder Side

Maxim cannot assume responsibility for use of any circuitry other than circuitry entirely embodied in a Maxim product. No circuit patent licenses are implied. Maxim reserves the right to change the circuitry and specifications without notice at any time.

Maxim Integrated Products, 120 San Gabriel Drive, Sunnyvale, CA 94086 408-737-7600 _____ 5