

**Used with: MAXM38643/MAX38640/
MAX77839/MAXM17225/MAX17227A/
MAX38889/MAX38902C/MAX38913/
MAX77827**

Essential Analog Efficient Power Toolkit

General Description

The MAXESSENTIAL02EP Essential Analog Efficient Power toolkit delivers products on ready-to-use boards for immediate testing and prototyping. The Essential Analog Efficient Power toolkit features products from the Buck, Boost, Buck-Boost, LDO, and Continua™ product categories. The selection also features nanoPower switching converter and module options.

Features

- Enables Immediate Testing of Nine Different Power Solutions
- Includes nanoPower Buck and Boost Converters and Modules, Buck/Boost Converter, LDOs, and Continua Supercapacitor Backup Power Controller
- Boards Designed to Accept 0.100" (2.54mm) Header Pin Strips for Mounting on Breadboards
- Through Holes Accept Test Points for Connecting to Benchtop Equipment

Quick Start

Required Equipment

- DC power supply with 2.5V, 1A output (MAX38889)
- DC power supply with 3.6V, 1A output (for all other devices)
- One voltmeter
- Four banana-to-clip cables

Procedure

- 1) Connect the power supply between the IN and nearest GND terminal posts. A voltage range is specified on the MAXESSENTIAL02EP kit board.
- 2) Board will be set with a default voltage specified on the board.
- 3) Connect the voltmeter to check the output voltage.
- 4) Repeat steps 1 to 3 for the MAX38889. VSYS is the IN and is also the OUT. Connect the power supply and voltage meter to VSYS. When the power supply is removed, the MAX38889 continues to output a voltage.

[Ordering Information](#) appears at end of data sheet.

Setup



Continua is a trademark of Maxim Integrated Inc.

319-100891; Rev 1; 3/22

TABLE OF CONTENTS

General Description	1
Features	1
Setup	1
Quick Start	1
Required Equipment	1
Procedure	4
Detailed Description of Hardware	4
MAXM38643A, Tiny 1.8V to 5.5V Input, 330nA IQ, 1A, 600mA nanoPower Buck Module.	4
MAXM38643A Bill of Materials	4
MAXM38643A Schematic	5
MAXM38643A PCB Layouts	6
MAX38640A, Tiny 1.8V to 5.5V Input, 330nA IQ, 700mA nanoPower Buck Converter.	8
MAX38640A Bill of Materials.	8
MAX38640A Schematic.	9
MAX38640A PCB Layouts	10
MAX77839D; 5.5V Input, 4.4A/3.6A Switching Current 6 μ A IQ Buck-Boost Converter.	12
MAX77839D Bill of Materials.	12
MAX77839D Schematic	13
MAX77839D PCB Layouts	14
MAXM17225, Tiny 1.8V to 5.5V Input, 300nA IQ, nanoPower Boost Module with True Shutdown	16
MAXM17225 Bill of Materials.	16
MAXM17225 Schematic.	17
MAXM17225 PCB Layouts	18
MAX17227A, 400mV to 5.5V Input, 2A nanoPower Boost Converter with Short-Circuit Protection and True Shutdown.	20
MAX17227A Bill of Materials	20
MAX17227A Schematic	21
MAX17227A PCB Layouts	22
MAX38889, 2.5V–5.5V, 3A Reversible Buck/boost Regulator for Backup Power Applications.	24
MAX38889 Bill of Materials	24
MAX38889 Schematic.	25
MAX38889 PCB Layouts.	26

TABLE OF CONTENTS (CONTINUED)

MAX38902C, 10.5 μ V _{RMS} Low Noise 500mA LDO Linear Regulator.	28
MAX38902C Bill of Materials.	28
MAX38902C Schematic	29
MAX38902C PCB Layouts	30
MAX38913, 4 μ V _{RMS} Ultra-Low-Noise 1A LDO with two-level output voltage selection.	32
MAX38913 Bill of Materials	32
MAX38913 Schematic	33
MAX38913 PCB Layouts	34
MAX77827A, 5.5V Input, 1.8A/3.1A Switch Buck-Boost Converter with 6 μ A IQ.	36
MAX77827A Bill of Materials.	36
MAX77827A Schematic.	37
MAX77827A PCB Layouts.	38
Ordering Information	40
Revision History	41

Essential Analog Efficient Power Toolkit

Used with: MAXM38643/MAX38640/
MAX77839/MAXM17225/MAX17227A/
MAX38889/MAX38902C/MAX38913/
MAX77827

Detailed Description of Hardware

MAXM38643A

The MAXM38643A is featured in the efficient power edition of the Essential Analog toolkit, MAXESSENTIAL02EP#. This small board provides a quick examination and testing

of the MAXM38643A, a tiny 1.8V to 5.5V input, 330nA IQ, 1A, 600mA nanoPower buck module. The board design and layout follow standard part recommendations. Refer to the product data sheet at www.maximintegrated.com/maxm38643 for more information. Use the product evaluation kit to examine the product thoroughly.

MAXM38643A Bill of Materials

ITEM	REF_DES	DNI/DNP	QTY	MFG PART #	MANUFACTURER	VALUE	DESCRIPTION
1	C1-C3	-	3	CL10A226KQ8NRN	SAMSUNG	22UF	CAP; SMT (0603); 22UF; 10%; 6.3V; X5R; CERAMIC
2	EXT_EN	-	1	5002	KEYSTONE	N/A	TEST POINT; PIN DIA=0.1IN; TOTAL LENGTH=0.3IN; BOARD HOLE=0.04IN; WHITE; PHOSPHOR BRONZE WIRE SILVER;
3	GND_1	-	1	5001	KEYSTONE	N/A	TEST POINT; PIN DIA=0.1IN; TOTAL LENGTH=0.3IN; BOARD HOLE=0.04IN; BLACK; PHOSPHOR BRONZE WIRE SILVER PLATE FINISH;
4	R8, R10	-	2	RC0402JR-070RL; CR0402-16W-000RJT	YAGEO PHYCOMP; VENKEL LTD.	0	RES; SMT (0402); 0; 5%; JUMPER; 0.0630W
5	R2	-	1	CRCW0603191KFK	VISHAY DALE	191K	RES; SMT (0603); 191K; 1%; +/-100PPM/DEGK; 0.1000W
6	R3	-	1	ERJ-3EKF6343	PANASONIC	634K	RES; SMT (0603); 634K; 1%; +/-100PPM/DEGC; 0.1000W
7	R4	-	1	CRCW0603768KFK	VISHAY DALE	768K	RES; SMT (0603); 768K; 1%; +/-100PPM/DEGC; 0.1000W
8	R5	-	1	CRCW060356K2FK; ERJ-3EKF5622	VISHAY;PANASONIC	56.2K	RES; SMT (0603); 56.2K; 1%; +/-100PPM/DEGC; 0.1000W
9	U1	-	1	MAXM38643AEMB+	MAXIM	MAXM38643AEMB+	EVKIT PART - IC; TINY 1.8V - 5.5V INPUT; 300NANO-AMP NANOPOWER IQ; 600 MILLI-AMP NANOPOWER BUCK MODULE; PACKAGE OUTLINE: 21-100245; PACKAGE LAND PATTERN: 90-100084; EMGA10
10	PCB	-	1	MAXM38643A_EMGA_APPS_P1	MAXIM	PCB	PCB:MAXM38643A_EMGA_APPS_P1
11	R1,R12, R6, R7, R9, R11	DNP	0	N/A	N/A	OPEN	RESISTOR; 0402; OPEN; FORMFACTOR
12	TP1, TP3	DNP	0	5002	KEYSTONE	N/A	TEST POINT; PIN DIA=0.1IN; TOTAL LENGTH=0.3IN; BOARD HOLE=0.04IN; WHITE; PHOSPHOR BRONZE WIRE SILVER;
13	TP2	DNP	0	5001	KEYSTONE	N/A	TEST POINT; PIN DIA=0.1IN; TOTAL LENGTH=0.3IN; BOARD HOLE=0.04IN; BLACK; PHOSPHOR BRONZE WIRE SILVER PLATE FINISH;
TOTAL			14				

MAXM38643A Schematic

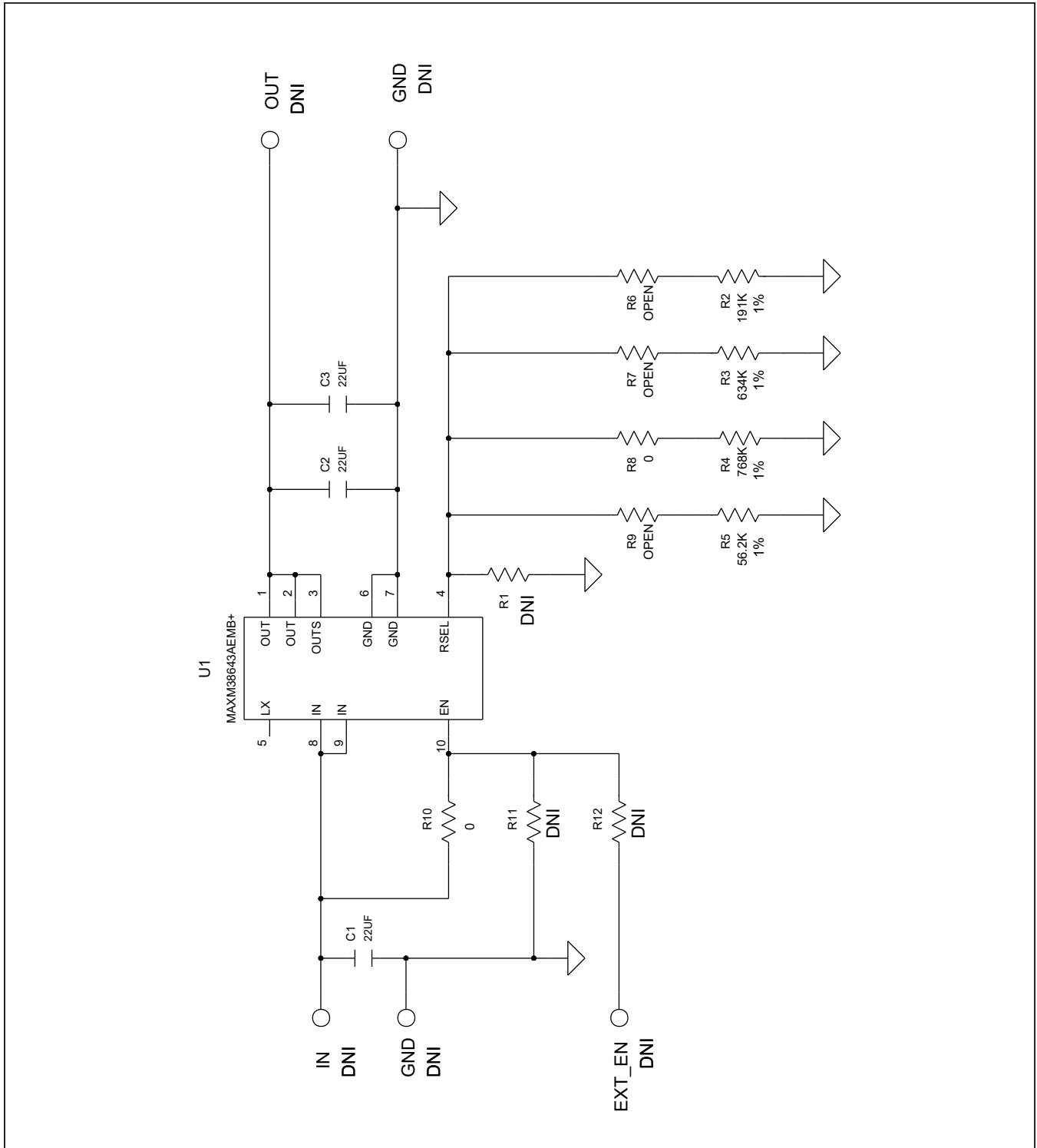

**Essential Analog
Efficient Power Toolkit**

Used with: MAXM38643/MAX38640/
MAX77839/MAXM17225/MAX17227A/
MAX38889/MAX38902C/MAX38913/
MAX77827

MAXM38643A PCB Layouts

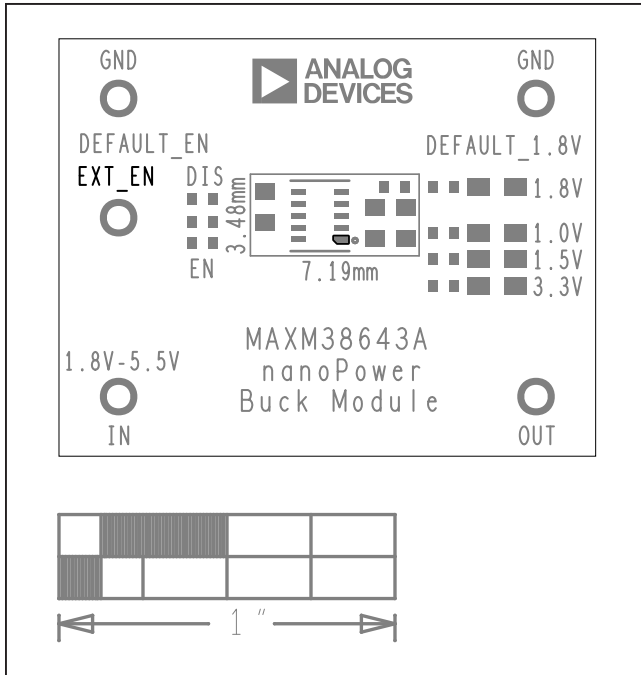

MAXM38643A EV System Component Placement Guide—Top Silkscreen

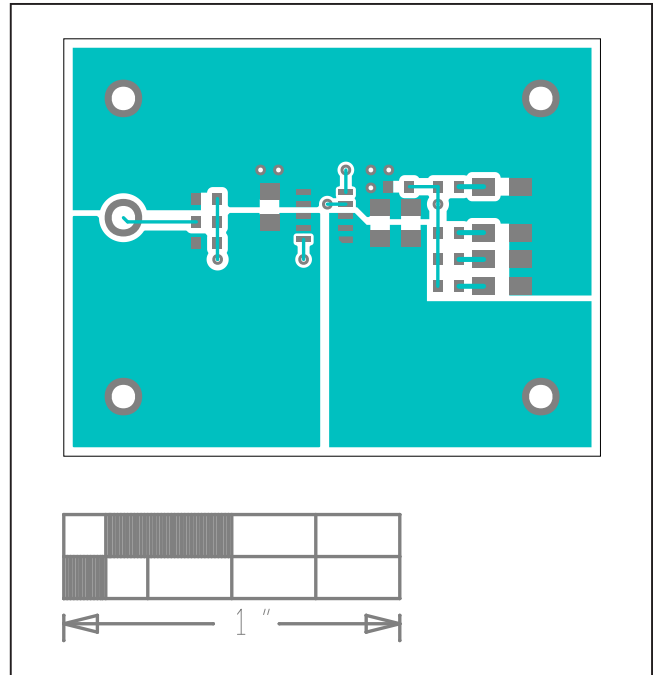

MAXM38643A EV System PCB Layout—Top

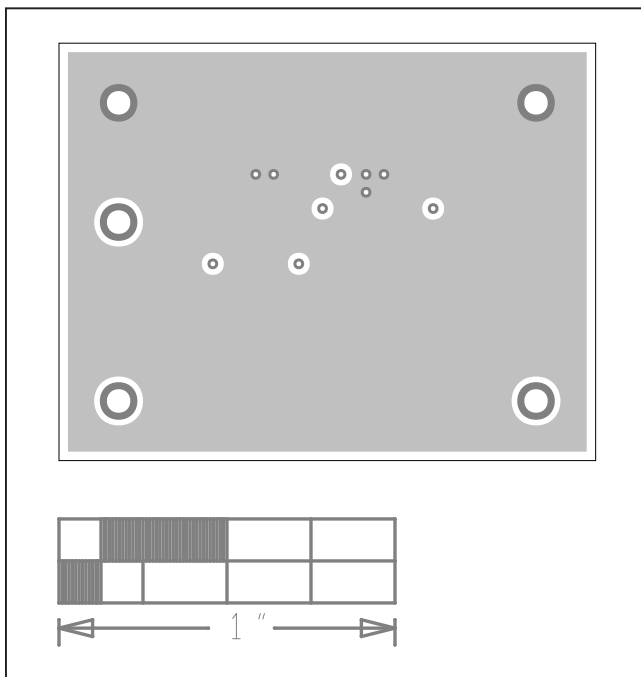

MAXM38643A EV System PCB Layout—Internal1

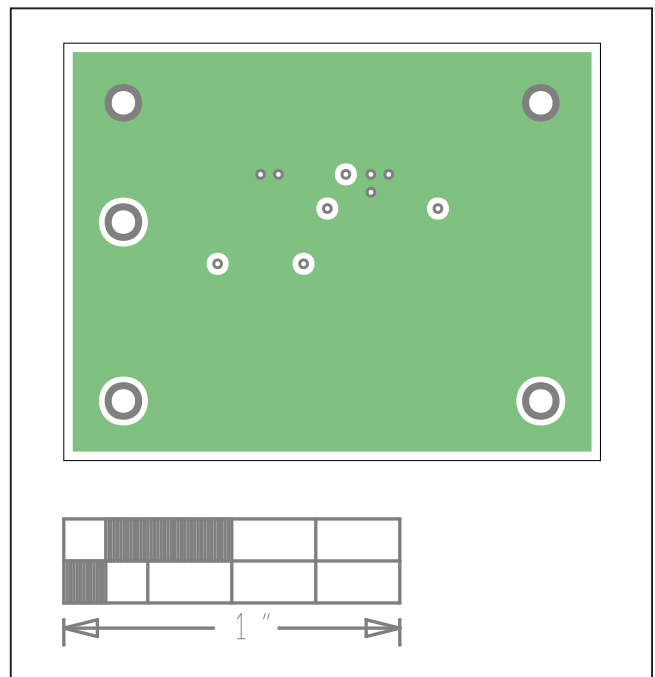

MAXM38643A EV System PCB Layout—Internal2

**Essential Analog
Efficient Power Toolkit**

Used with: MAXM38643/MAX38640/
MAX77839/MAXM17225/MAX17227A/
MAX38889/MAX38902C/MAX38913/
MAX77827

MAXM38643A PCB Layouts (continued)

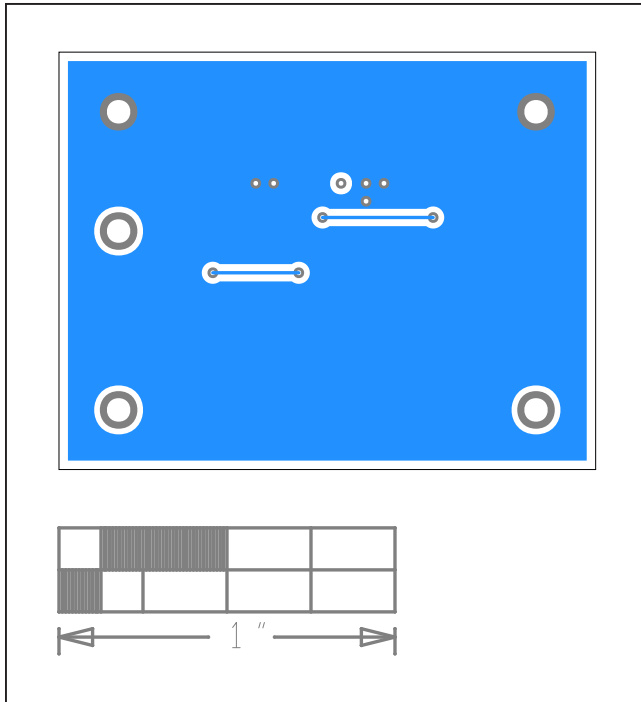

MAXM38643A EV System PCB Layout—Bottom

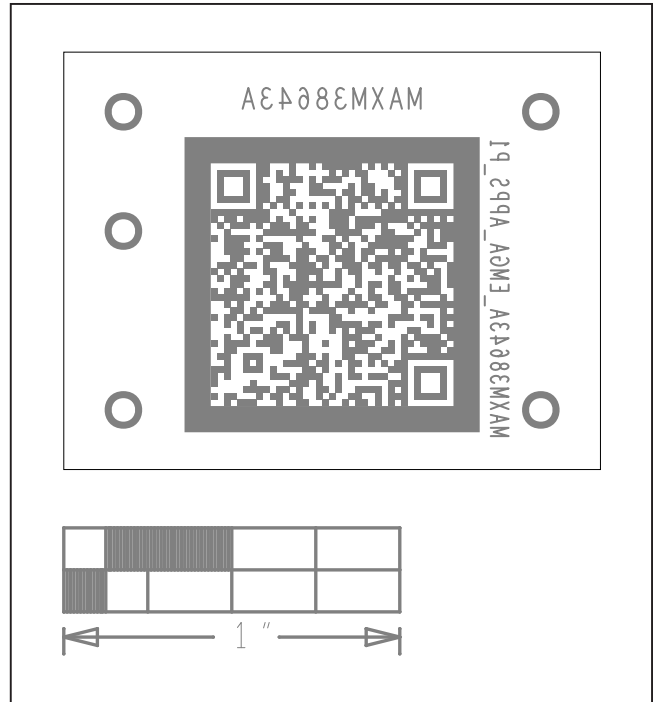

MAXM38643A EV System PCB Layout—Bottom Silkscreen

[BACK TO TABLE OF CONTENTS](#)

Essential Analog Efficient Power Toolkit

Used with: MAXM38643/MAX38640/
MAX77839/MAXM17225/MAX17227A/
MAX38889/MAX38902C/MAX38913/
MAX77827

MAX38640A

The MAX38640A is featured in the efficient power edition of the Essential Analog toolkit, MAXESSENTIAL02EP#. This small board provides a quick examination and testing of the MAX38640, a tiny 1.8V to 5.5V input, 330nA IQ,

700mA nanoPower buck converter. The board design and layout follow standard part recommendations. Refer to the product data sheet at www.maximintegrated.com/max38640 for more information. Use the product evaluation kit to examine the product thoroughly.

MAX38640A Bill of Materials

ITEM	REF_DES	DNI/DNP	QTY	MFG PART #	MANUFACTURER	VALUE	DESCRIPTION
1	C1	-	1	C1608X5R1A106K080AC	TDK	10UF	CAP; SMT (0603); 10UF; 10%; 10V; X5R; CERAMIC
2	C2	-	1	CL10A226KQ8NRN	SAMSUNG	22UF	CAP; SMT (0603); 22UF; 10%; 6.3V; X5R; CERAMIC
3	L1	-	1	1285AS-H-2R2M	TOKO	2.2UH	INDUCTOR; SMT (2016); METAL ALLOY CHIP; 2.2UH; TOL=+/-20%; 1.4A
4	R2	-	1	CRCW0603191KFK	VISHAY DALE	191K	RES; SMT (0603); 191K; 1%; +/-100PPM/DEGK; 0.1000W
5	R3	-	1	ERJ-3EKF6343	PANASONIC	634K	RES; SMT (0603); 634K; 1%; +/-100PPM/DEGC; 0.1000W
6	R4	-	1	CRCW0603768KFK	VISHAY DALE	768K	RES; SMT (0603); 768K; 1%; +/-100PPM/DEGC; 0.1000W
7	R5	-	1	CRCW060356K2FK; ERJ-3EKF5622	VISHAY;PANASONIC	56.2K	RES; SMT (0603); 56.2K; 1%; +/-100PPM/DEGC; 0.1000W
8	R8, R10	-	2	RC0402JR-070RL; CR0402-16W-000RJT	YAGEO PHYCOMP; VENKEL LTD.	0	RES; SMT (0402); 0; 5%; JUMPER; 0.0630W
9	U1	-	1	MAX38640AENT+	MAXIM	MAX38640AENT+	EVKIT PART - IC; TINY 300NANO-AMP NANOPOWER BUCK CONVERTER; PACKAGE OUTLINE: 21-100128; PACKAGE CODE: N60E1+1; WLP6
10	PCB	-	1	MAX38640A_WLP_APPS_P1	MAXIM	PCB	PCB:MAX38640A_WLP_APPS_P1
11	R1	DNP	0	CRCW06030000Z0	VISHAY DALE	0	RES; SMT (0603); 0; JUMPER; JUMPER; 0.1000W
12	R12, R6, R7, R9, R11	DNP	0	N/A	N/A	OPEN	RESISTOR; 0402; OPEN; FORMFACTOR
13	TP1, TP3, TP5	DNP	0	5002	KEYSTONE	N/A	TEST POINT; PIN DIA=0.1IN; TOTAL LENGTH=0.3IN; BOARD HOLE=0.04IN; WHITE; PHOSPHOR BRONZE WIRE SILVER;
14	TP2, TP4	DNP	0	5001	KEYSTONE	N/A	TEST POINT; PIN DIA=0.1IN; TOTAL LENGTH=0.3IN; BOARD HOLE=0.04IN; BLACK; PHOSPHOR BRONZE WIRE SILVER PLATE FINISH;
TOTAL			11				

MAX38640A Schematic

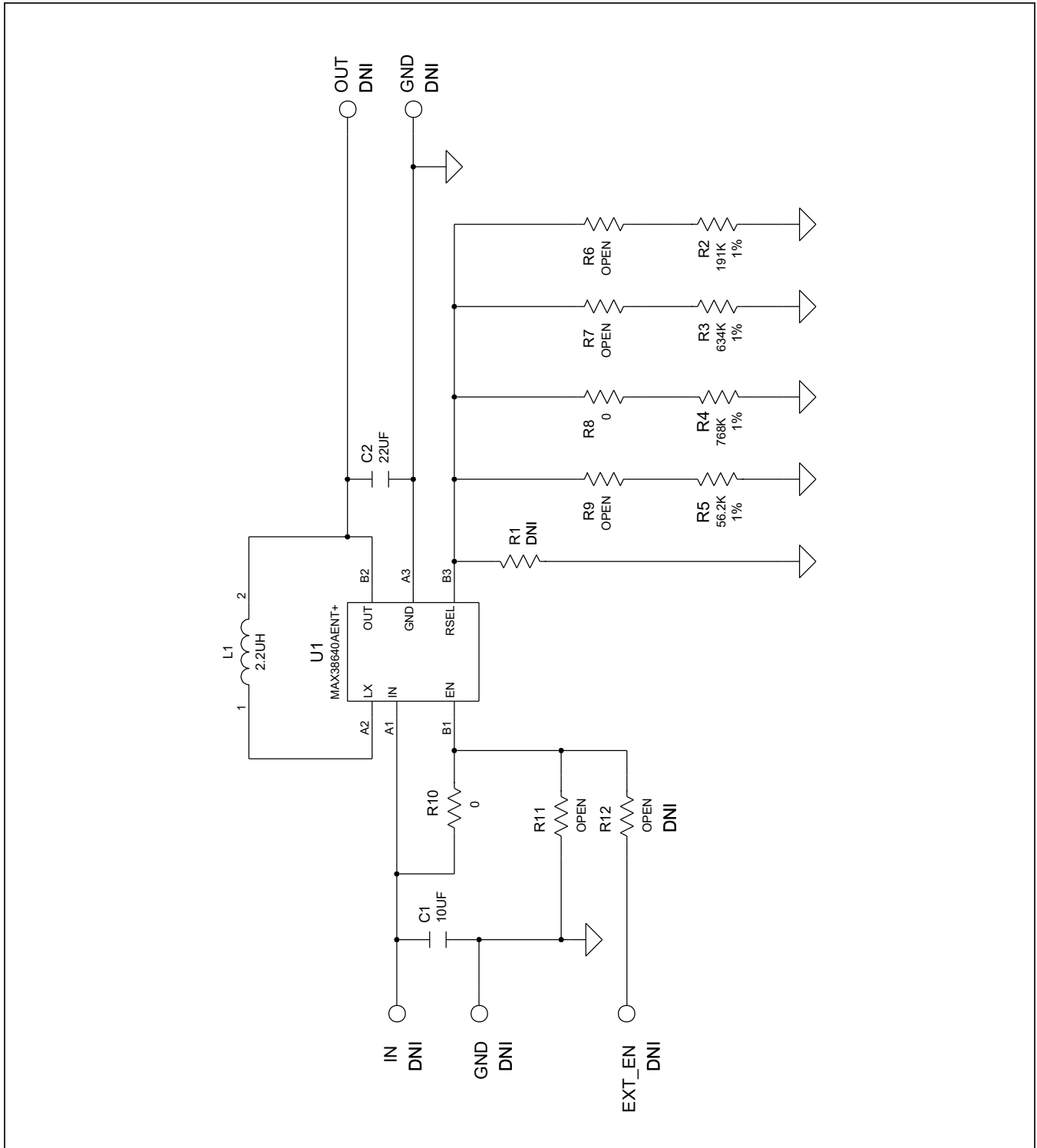

Essential Analog Efficient Power Toolkit

Used with: MAXM38643/MAX38640/
MAX77839/MAXM17225/MAX17227A/
MAX38889/MAX38902C/MAX38913/
MAX77827

MAX38640A PCB Layouts

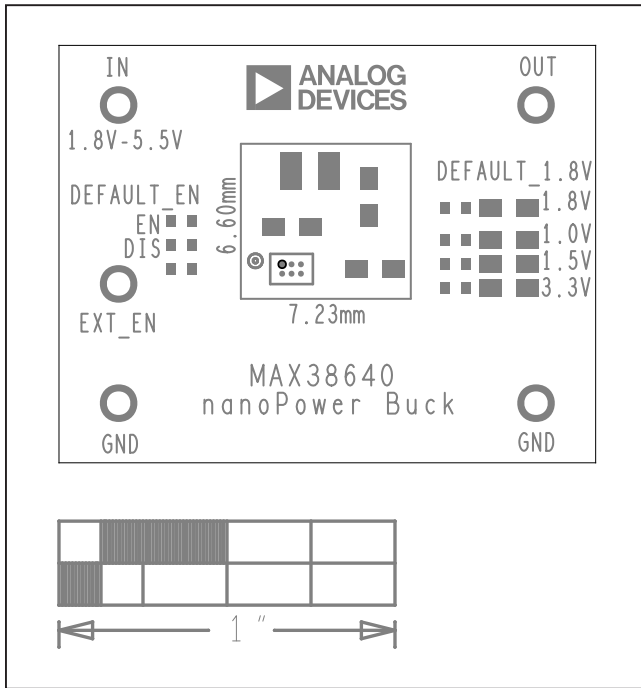

MAX38640A EV System Component Placement Guide—Top Silkscreen

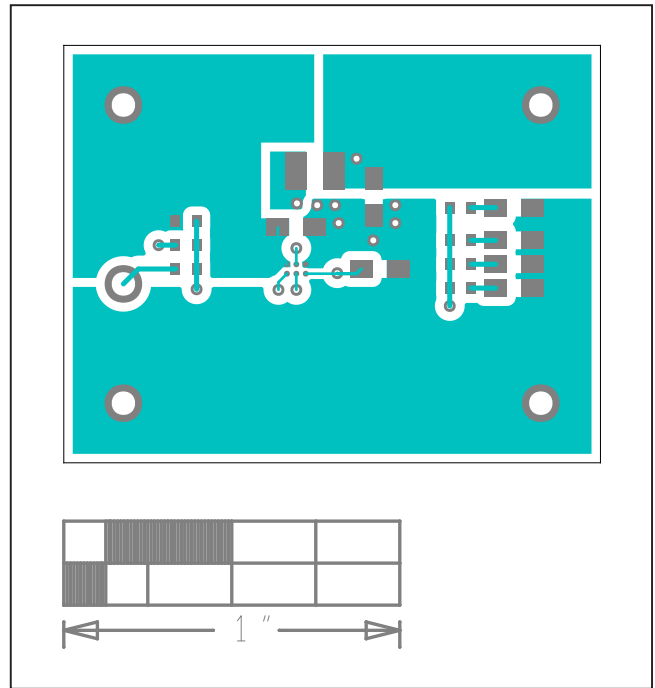

MAX38640A EV System PCB Layout—Top

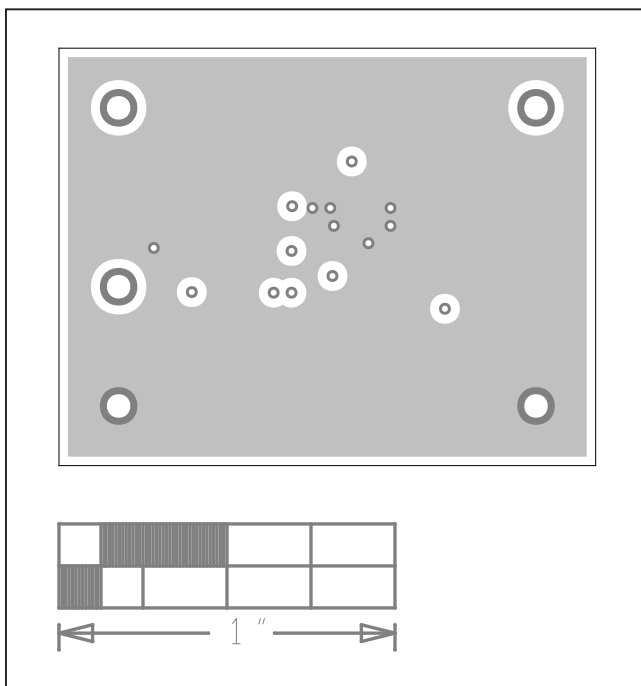

MAX38640A EV System PCB Layout—Internal1

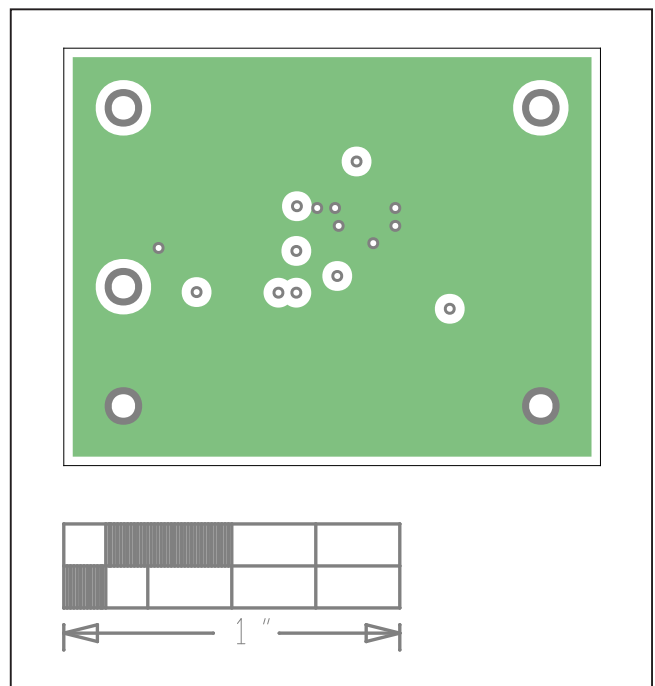

MAX38640A EV System PCB Layout—Internal2

**Essential Analog
Efficient Power Toolkit**

Used with: MAXM38643/MAX38640/
MAX77839/MAXM17225/MAX17227A/
MAX38889/MAX38902C/MAX38913/
MAX77827

MAX38640A PCB Layouts (continued)

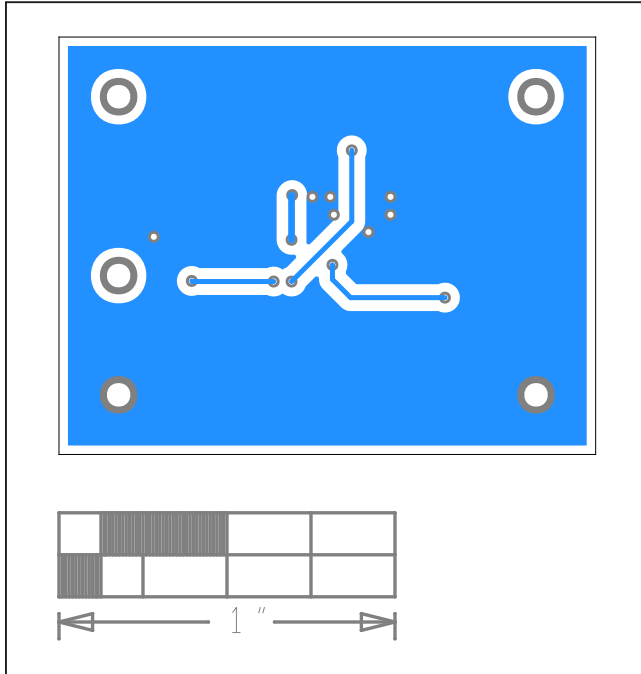

MAX38640A EV System PCB Layout—Bottom

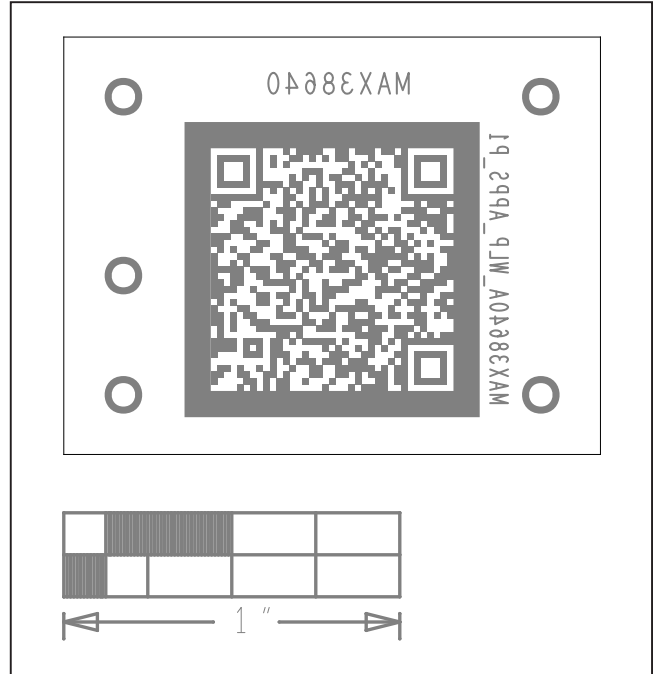

MAX38640A EV System PCB Layout—Bottom Silkscreen

[BACK TO TABLE OF CONTENTS](#)

Essential Analog Efficient Power Toolkit

Used with: MAXM38643/MAX38640/
MAX77839/MAXM17225/MAX17227A/
MAX38889/MAX38902C/MAX38913/
MAX77827

MAX77839D

The MAX77839D is featured in the efficient power edition of the Essential Analog toolkit, MAXESSENTIAL02EP#. This small board provides a quick examination and testing of the MAX77839D, 5.5V input, 4.4A/3.6A switching cur-

rent 6 μ A IQ buck-boost converter. The board design and layout follow standard part recommendations. Refer to the product data sheet at www.maximintegrated.com/max77839 for more information. Use the product evaluation kit to examine the product thoroughly.

MAX77839D Bill of Materials

ITEM	QTY	REF DES	MFG PART #	MANUFACTURER	VALUE	DESCRIPTION
1	1	C1	GRM188D71A106MA73	MURATA	10UF	CAP; SMT (0603); 10UF; 20%; 10V; X7T; CERAMIC
2	1	C2	GRM188R60J476ME15	MURATA	47UF	CAP; SMT (0603); 47UF; 20%; 6.3V; X5R; CERAMIC
3	1	C3	GRM155R70J105MA12	MURATA	1UF	CAP; SMT (0402); 1UF; 20%; 6.3V; X7R; CERAMIC
4	1	L1	HTEK20161T-1R0MSR	CYNTEC	1UH	INDUCTOR; SMT (0806); COMPOSITE; 1UH; 20%; 4.5A
5	2	R1, R2	RC0402JR-070RL; CR0402-16W-000RJT	YAGEO PHYCOMP;VENKEL LTD.	0	RES; SMT (0402); 0; 5%; JUMPER; 0.0630W
6	1	R4	ERJ-2GEJ153	PANASONIC	15K	RES; SMT (0402); 15K; 5%; +/-200PPM/DEGC; 0.1000W
7	1	U1	MAX77839DEWL+	MAXIM	MAX77839DEWL+	IC; 5.5V INPUT 4.4A/3.6A SWITCHING CURRENT 6MICRO-AMPERE IQ BUCK-BOOST CONVERTER; WLP15
8	1	PCB	MAX77839_WLP_APPS_P1	MAXIM	PCB	PCB:MAX77839_WLP_APPS_P1
TOTAL	9					

DO NOT PURCHASE(DNP)

ITEM	QTY	REF DES	MFG PART #	MANUFACTURER	VALUE	DESCRIPTION
1	2	J1, J2	PCC03SAAN	SULLINS	PCC03SAAN	CONNECTOR; MALE; THROUGH HOLE; BREAKAWAY; STRAIGHT THROUGH; 3PINS; -65 DEGC TO +125 DEGC
2	1	R3	RC0402JR-070RL; CR0402-16W-000RJT	YAGEO PHYCOMP;VENKEL LTD.	0	RES; SMT (0402); 0; 5%; JUMPER; 0.0630W
TOTAL	3					

MAX77839D Schematic

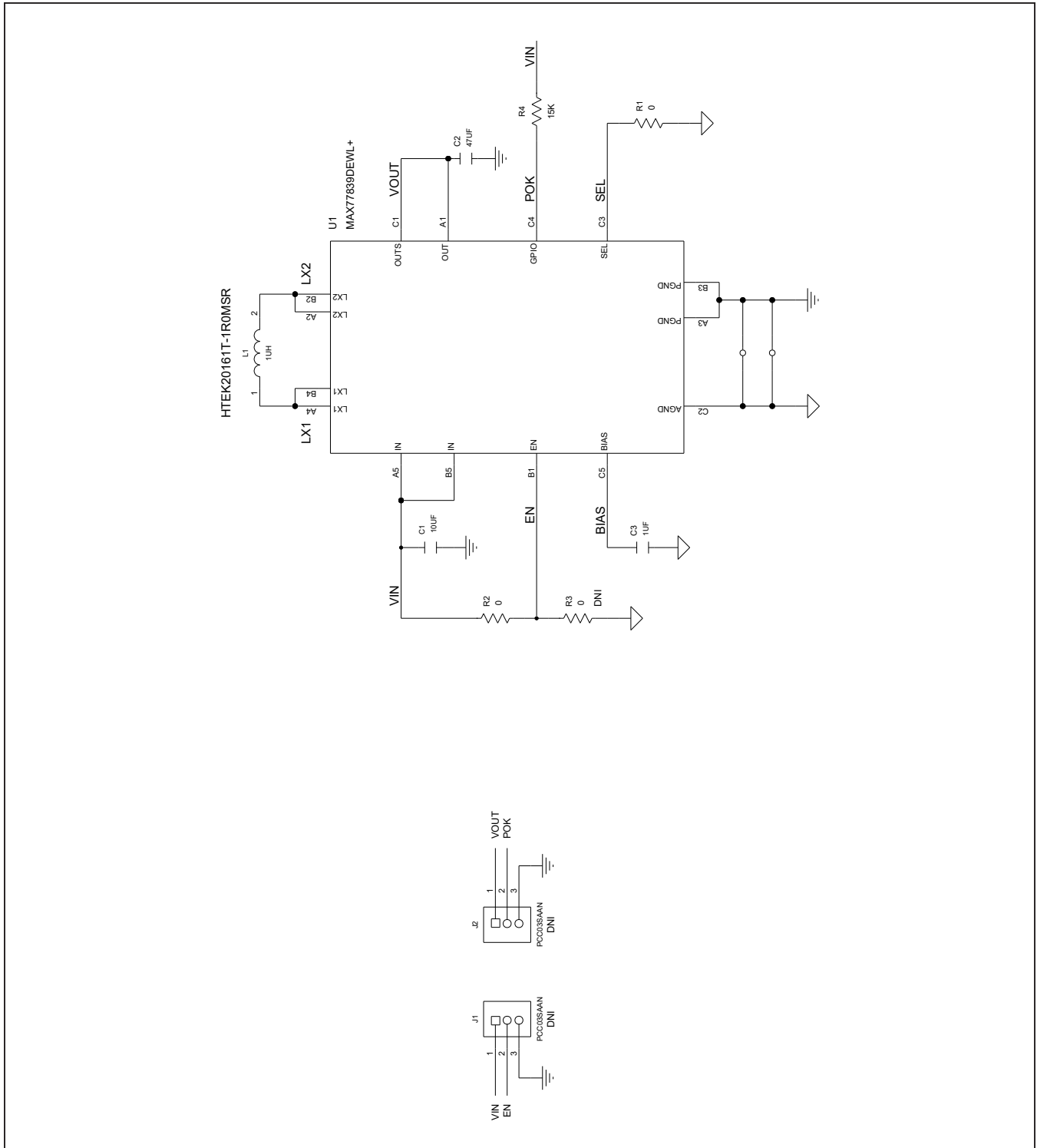

**Essential Analog
Efficient Power Toolkit**

Used with: MAXM38643/MAX38640/
MAX77839/MAXM17225/MAX17227A/
MAX38889/MAX38902C/MAX38913/
MAX77827

MAX77839D PCB Layouts

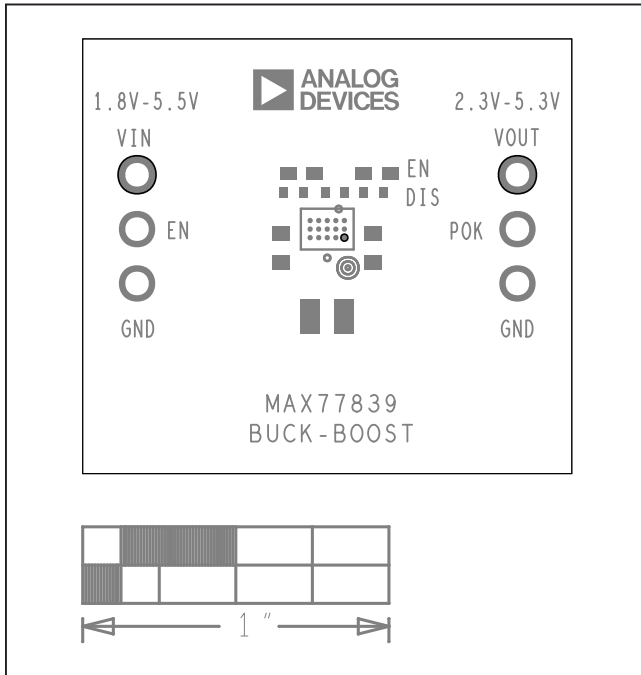

MAX77839D EV System Component Placement Guide—Top Silkscreen

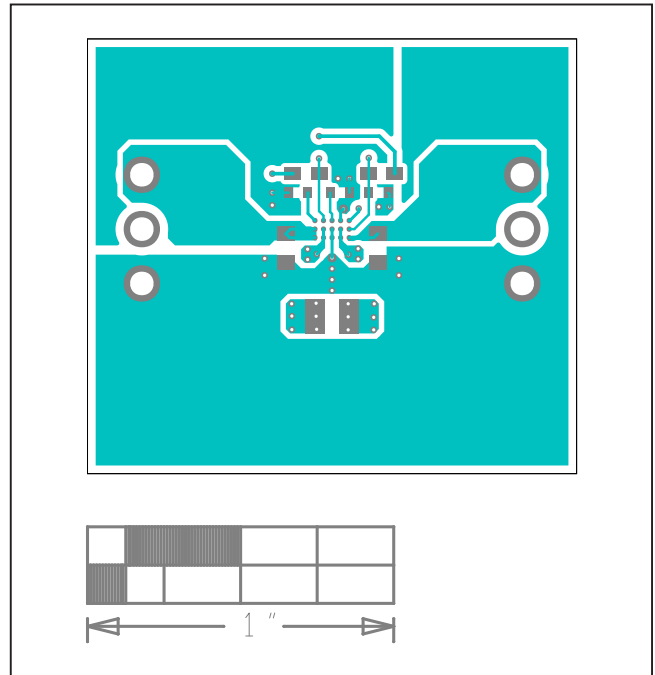

MAX77839D EV System PCB Layout—Top

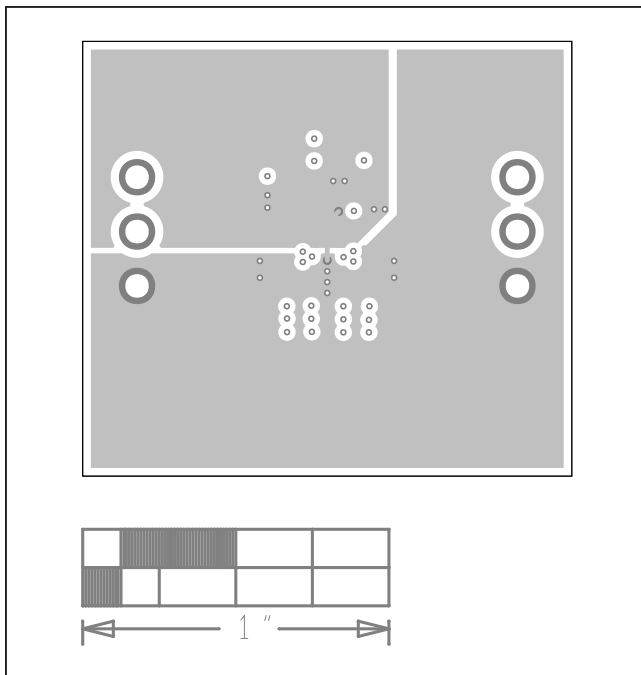

MAX77839D EV System PCB Layout—Internal1

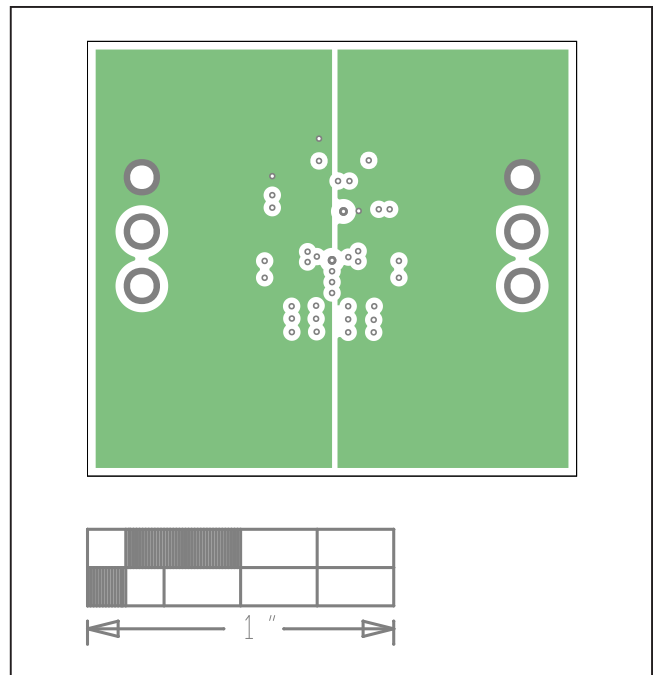

MAX77839D EV System PCB Layout—Internal2

**Essential Analog
Efficient Power Toolkit**

Used with: MAXM38643/MAX38640/
MAX77839/MAXM17225/MAX17227A/
MAX38889/MAX38902C/MAX38913/
MAX77827

MAX77839D PCB Layouts (continued)

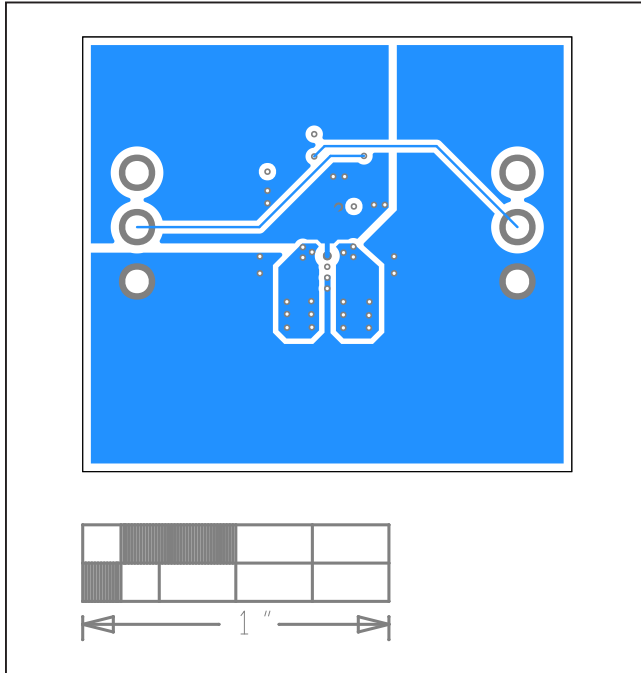

MAX77839D EV System PCB Layout—Bottom

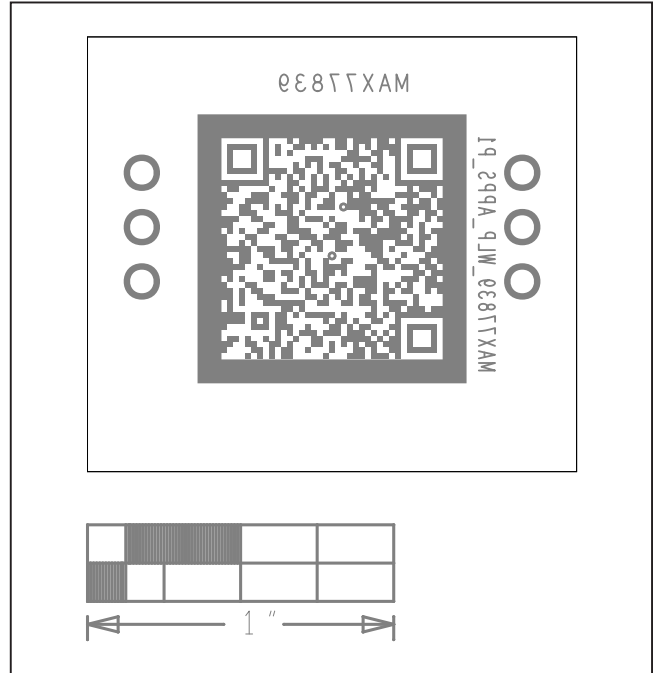

MAX77839D EV System PCB Layout—Bottom Silkscreen

[BACK TO TABLE OF CONTENTS](#)

Essential Analog Efficient Power Toolkit

Used with: MAXM38643/MAX38640/
MAX77839/MAXM17225/MAX17227A/
MAX38889/MAX38902C/MAX38913/
MAX77827

MAXM17225

The MAXM17225 is featured in the efficient power edition of the Essential Analog toolkit, MAXESSENTIAL02EP#. This small board provides a quick examination and testing of the MAXM17225, a tiny 1.8V to 5.5V input, 300nA

IQ, nanoPower boost module with True Shutdown™. The board design and layout follow standard part recommendations. Refer to the product data sheet at www.maximintegrated.com/maxm17225 for more information. Use the product evaluation kit to examine the product thoroughly.

MAXM17225 Bill of Materials

ITEM	QTY	REF DES	MFG PART #	MANUFACTURER	VALUE	DESCRIPTION
1	2	C2, C3	CL10B106MQ8NRN	SAMSUNG ELECTRONICS	10UF	CAP; SMT (0603); 10UF; 20%; 6.3V; X7R; CERAMIC
2	1	R2	CRCW0603324KFK	VISHAY DALE	324K	RES; SMT (0603); 324K; 1%; +/-100PPM/DEGC; 0.1000W
3	1	R3	CRCW0603133KFK; RK73H1JTTD1333F	VISHAY DALE; KOA SPEER	133K	RES; SMT (0603); 133K; 1%; +/-100PPM/DEGC; 0.1000W
4	1	R4	CRCW060323K7FK	VISHAY DALE	23.7K	RES; SMT (0603); 23.7K; 1%; +/-100PPM/DEGC; 0.1000W
5	1	R5	RC0603FR-070RL	YAGEO	0	RES; SMT (0603); 0; 1%; JUMPER; 0.1000W
6	2	R7, R10	RC0402JR-070RL; CRO402-16W-000RJT	YAGEO PHYCOMP; VENKEL LTD.	0	RES; SMT (0402); 0; 5%; JUMPER; 0.0630W
7	1	U1	MAXM17225	MAXIM	MAXM17225	EVKIT PART - IC; TINY 1.8V - 5.5V INPUT; 300NANO-AMP IQ; 1A PEAK CURRENT NANOPOWER BOOST MODULE; PACKAGE OUTLINE: 21-100245; PACKAGE LAND PATTERN: 90-100084; EMGA10
8	1	PCB	MAXM17225_EMGA_APPS_P1	MAXIM	PCB	PCB:MAXM17225_EMGA_APPS_P1
TOTAL	10					

DO NOT PURCHASE(DNP)

ITEM	QTY	REF DES	MFG PART #	MANUFACTURER	VALUE	DESCRIPTION
1	1	R1	ERJ-2RKF8062	PANASONIC	80.6K	RES; SMT (0402); 80.6K; 1%; +/-100PPM/DEGK; 0.1000W
2	5	R12, R6, R8, R9, R11	N/A	N/A	OPEN	RESISTOR; 0402; OPEN; FORMFACTOR
3	3	TP1, TP4, TP5	5002	KEystone	N/A	TEST POINT; PIN DIA=0.1IN; TOTAL LENGTH=0.3IN; BOARD HOLE=0.04IN; WHITE; PHOSPHOR BRONZE WIRE SILVER; NOT FOR COLD TEST
4	2	TP2, TP3	5001	KEystone	N/A	TEST POINT; PIN DIA=0.1IN; TOTAL LENGTH=0.3IN; BOARD HOLE=0.04IN; BLACK; PHOSPHOR BRONZE WIRE SILVER PLATE FINISH; RECOMMENDED FOR BOARD THICKNESS=0.062IN; NOT FOR COLD TEST
TOTAL	11					

True Shutdown is a trademark of Maxim Integrated Products, Inc.

MAXM17225 Schematic

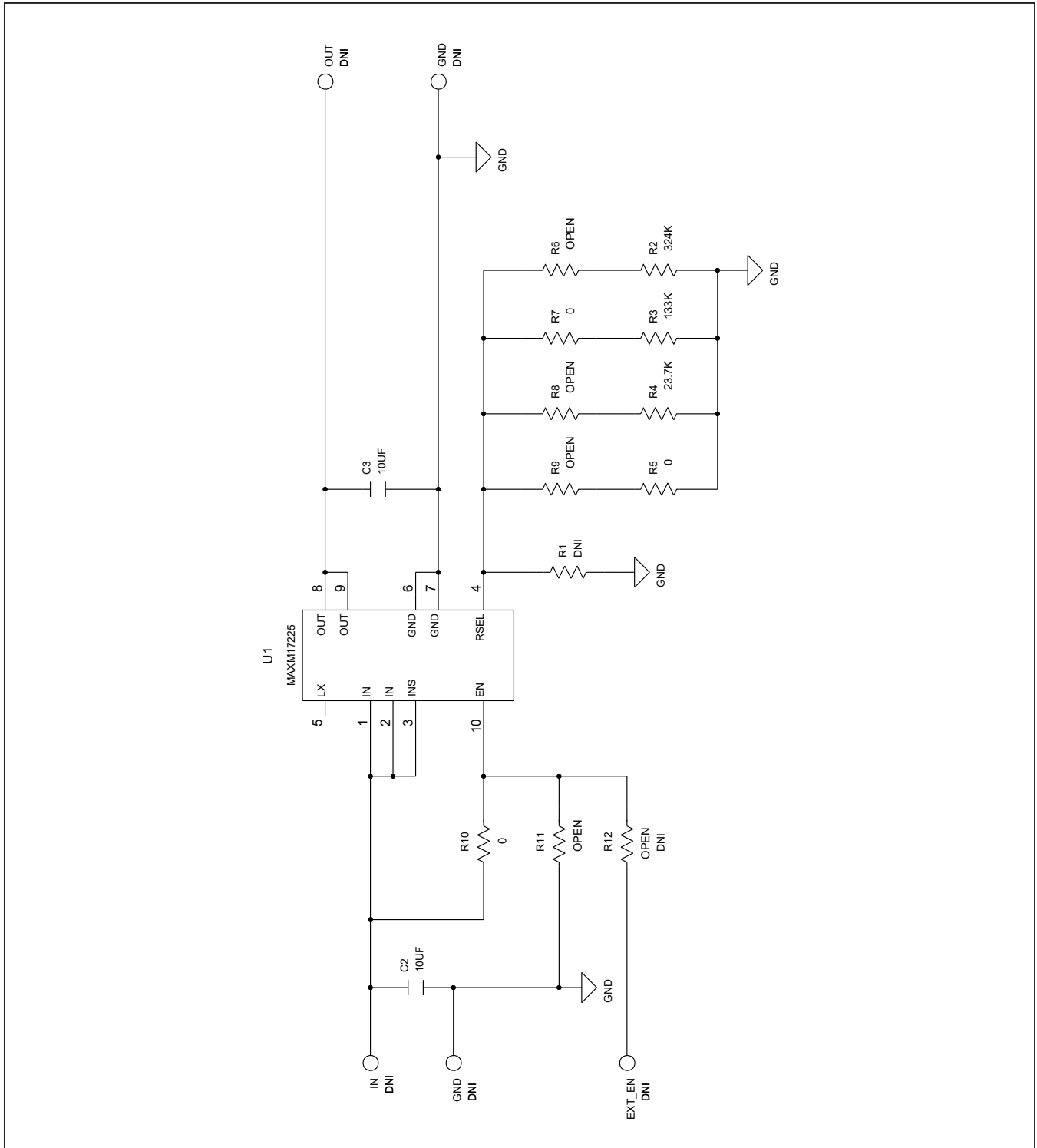

**Essential Analog
Efficient Power Toolkit**

Used with: MAXM38643/MAX38640/
MAX77839/MAXM17225/MAX17227A/
MAX38889/MAX38902C/MAX38913/
MAX77827

MAXM17225 PCB Layouts

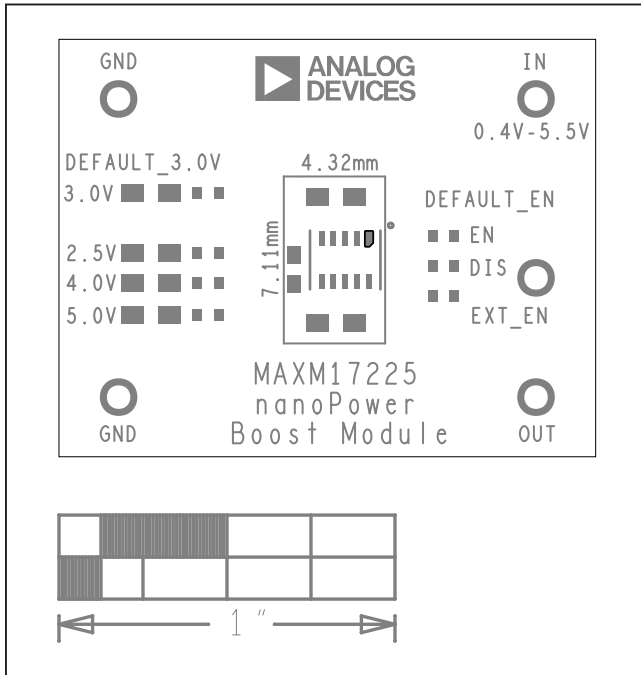

MAXM17225 EV System Component Placement Guide—Top Silkscreen

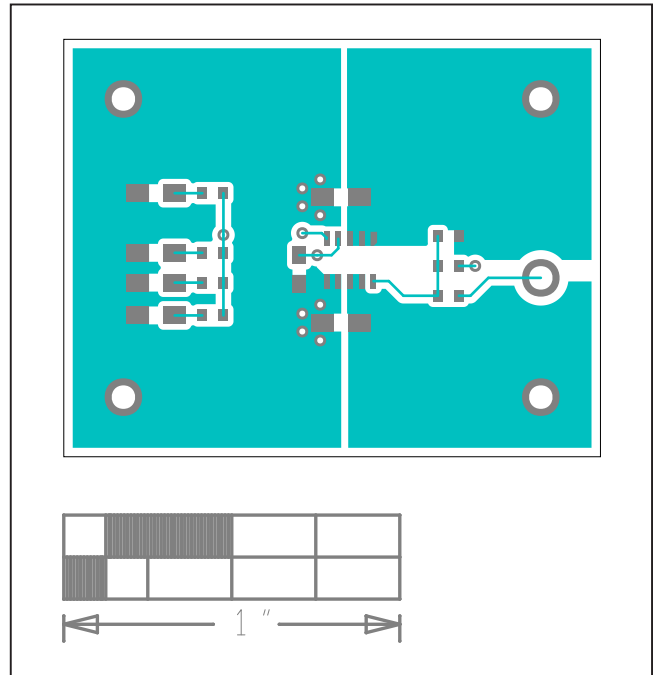

MAXM17225 EV System PCB Layout—Top

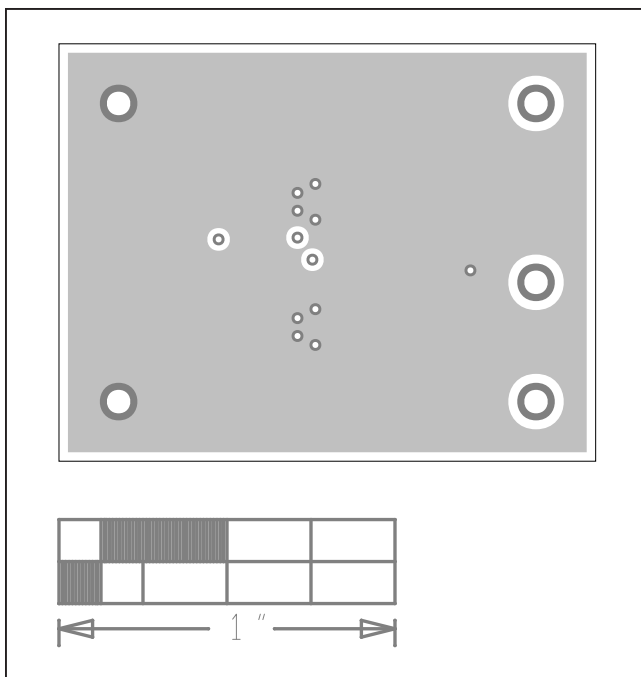

MAXM17225 EV System PCB Layout—Internal1

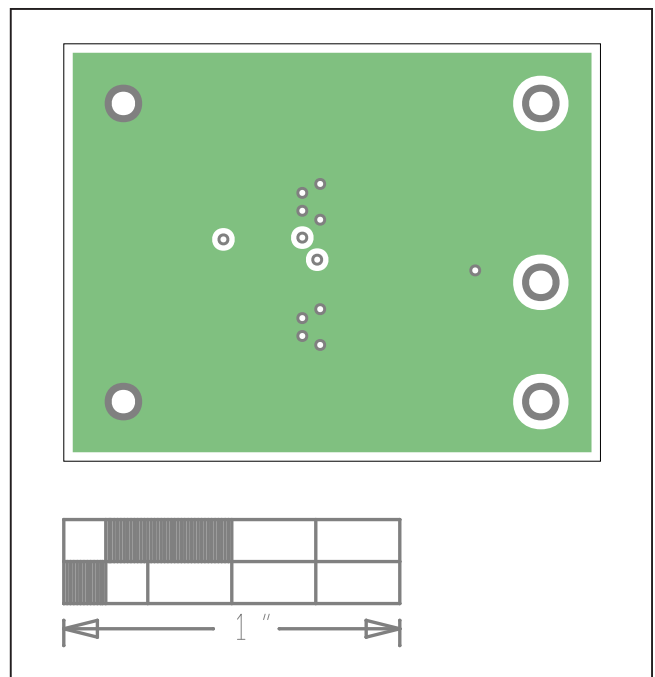

MAXM17225 EV System PCB Layout—Internal2

**Essential Analog
Efficient Power Toolkit**

Used with: MAXM38643/MAX38640/
MAX77839/MAXM17225/MAX17227A/
MAX38889/MAX38902C/MAX38913/
MAX77827

MAXM17225 PCB Layouts (continued)

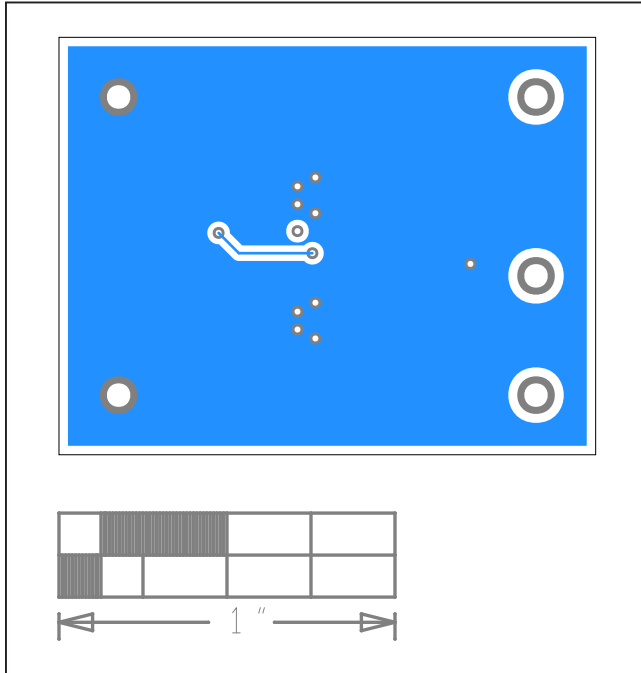

MAXM17225 EV System PCB Layout—Bottom

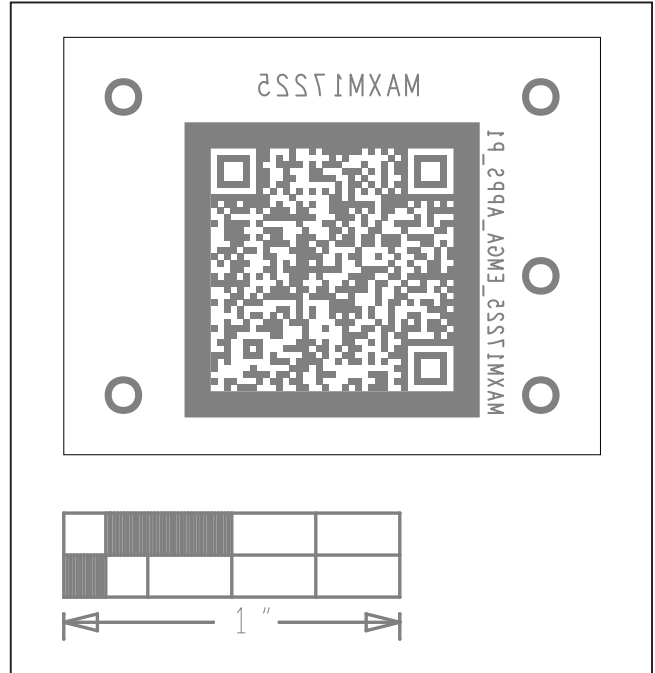

MAXM17225 EV System PCB Layout—Bottom Silkscreen

[BACK TO TABLE OF CONTENTS](#)

Essential Analog Efficient Power Toolkit

Used with: MAXM38643/MAX38640/
MAX77839/MAXM17225/MAX17227A/
MAX38889/MAX38902C/MAX38913/
MAX77827

MAX17227A

The MAX17227A is featured in the efficient power edition of the Essential Analog toolkit, MAXESSENTIAL02EP#. This small board provides a quick examination and testing of the MAX17227A, 400mV to 5.5V Input, 2A nanoPower

boost converter with short-circuit protection and True Shutdown. The board design and layout follow standard part recommendations. Refer to the the product data sheet at www.maximintegrated.com/max17227A for more information. Use the product evaluation kit to examine the product thoroughly.

MAX17227A Bill of Materials

ITEM	QTY	REF DES	MFG PART #	MANUFACTURER	VALUE	DESCRIPTION
1	2	C1, C2	GRM31CR71A226KE15; GCM31CR71A226KE01; GMC31X7R226K10NT	MURATA;MURATA; CAL-CHIP ELECTRONIC INC.	22UF	CAP; SMT (1206); 22UF; 10%; 10V; X7R; CERAMIC
2	1	L1	DFE18SAN1ROME0	MURATA	1UH	INDUCTOR; SMT (0603); METAL; 1UH; 20%; 1.6A
3	1	R2	CRCW0603768KFK	VISHAY DALE	768K	RES; SMT (0603); 768K; 1%; +/-100PPM/DEGC; 0.1000W
4	1	R3	CRCW0603324KFK	VISHAY DALE	324K	RES; SMT (0603); 324K; 1%; +/-100PPM/DEGC; 0.1000W
5	1	R4	CRCW060356K2FK; ERJ-3EKF5622	VISHAY;PANASONIC	56.2K	RES; SMT (0603); 56.2K; 1%; +/-100PPM/DEGC; 0.1000W
6	1	R5	CRCW060310K0FK; ERJ-3EKF1002; AC0603FR-0710KL; RMC0603FT10K0	VISHAY DALE; PANASONIC;YAGEO	10K	RES; SMT (0603); 10K; 1%; +/-100PPM/DEGC; 0.1000W
7	2	R7, R10	RC0402JR-070RL; CR0402-16W-000RJT	YAGEO PHYCOMP; VENKEL LTD.	0	RES; SMT (0402); 0; 5%; JUMPER; 0.0630W
8	1	U1	MAX17227AANT+	MAXIM	MAX17227AANT+	EVKIT PART - IC; MAX17227AANT+; NANOPOWER FAMILY BOOST CONVERTERS WITH 2A PEAK INDUCTOR CURRENT; SHORT CIRCUIT PROTECTION; TRUE/PASS THROUGH SHUTDOWN MODE; PACKAGE OUTLINE DRAWING: 21-100390; PACKAGE CODE: N60L1+2
9	1	PCB	MAX17227A_WLP_APPS_P1	MAXIM	PCB	PCB:MAX17227A_WLP_APPS_P1
TOTAL	11					

DO NOT PURCHASE(DNP)

ITEM	QTY	REF DES	MFG PART #	MANUFACTURER	VALUE	DESCRIPTION
1	6	R12, R1, R6, R8, R9, R11	N/A	N/A	OPEN	RESISTOR; 0402; OPEN; FORMFACTOR
2	3	TP1, TP4, TP5	5002	KEystone	N/A	TEST POINT; PIN DIA=0.1IN; TOTAL LENGTH=0.3IN; BOARD HOLE=0.04IN; WHITE; PHOSPHOR BRONZE WIRE SILVER; NOT FOR COLD TEST
3	2	TP2, TP3	5001	KEystone	N/A	TEST POINT; PIN DIA=0.1IN; TOTAL LENGTH=0.3IN; BOARD HOLE=0.04IN; BLACK; PHOSPHOR BRONZE WIRE SILVER PLATE FINISH; RECOMMENDED FOR BOARD THICKNESS=0.062IN; NOT FOR COLD TEST
TOTAL	11					

MAX17227A Schematic

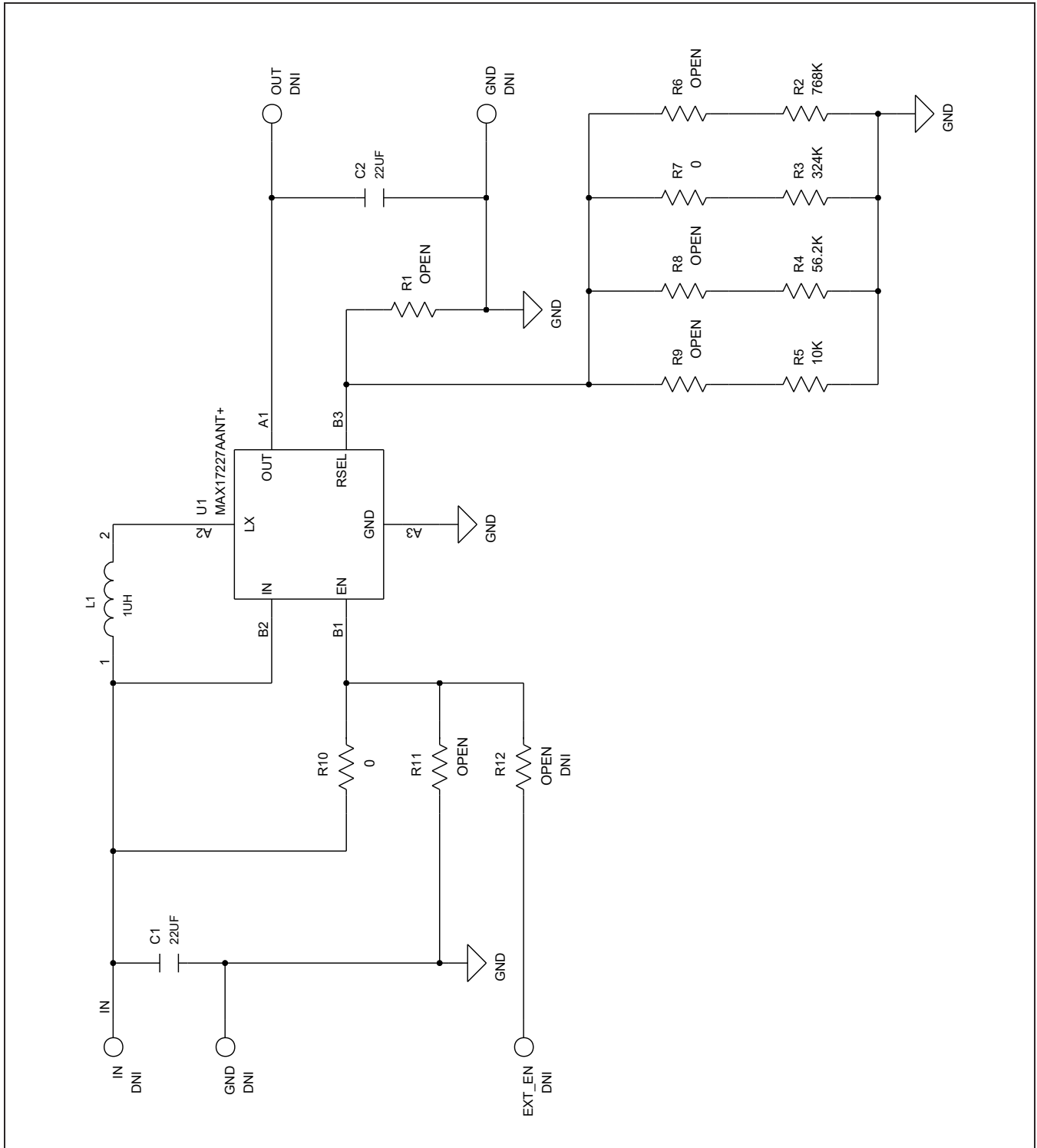

**Essential Analog
Efficient Power Toolkit**

Used with: MAXM38643/MAX38640/
MAX77839/MAXM17225/MAX17227A/
MAX38889/MAX38902C/MAX38913/
MAX77827

MAX17227A PCB Layouts

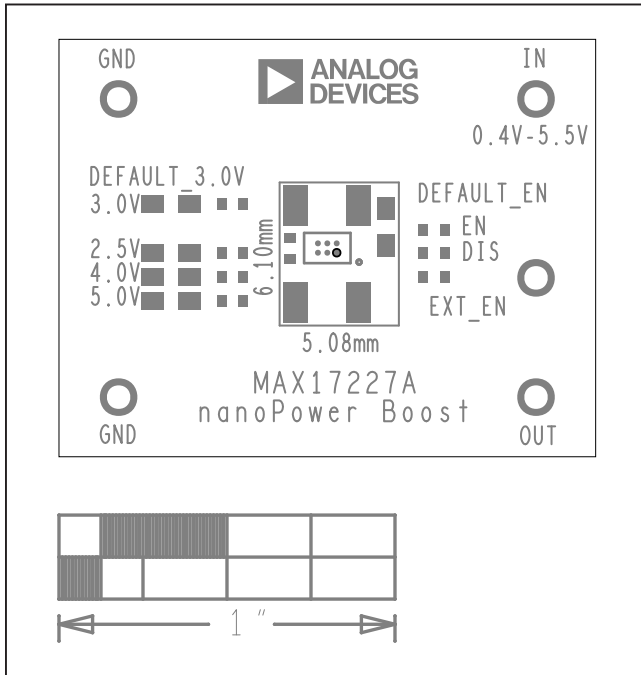

MAX17227A EV System Component Placement Guide—Top Silkscreen

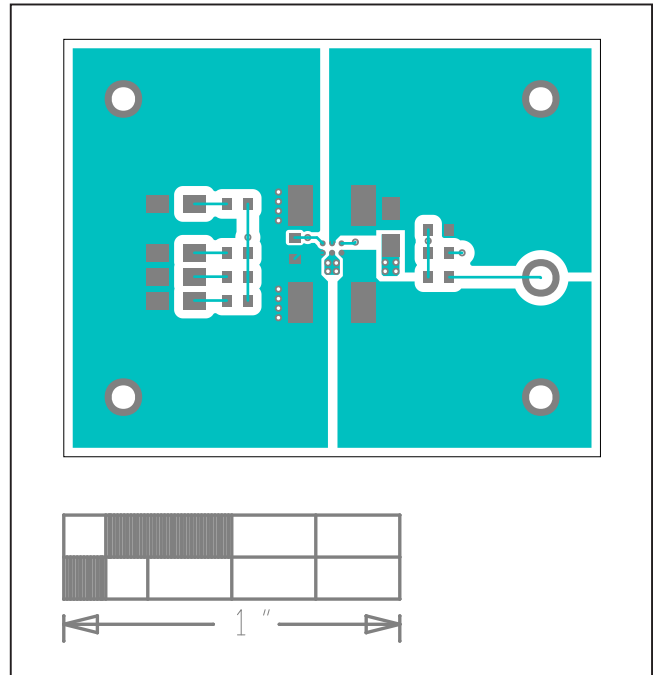

MAX17227A EV System PCB Layout—Top

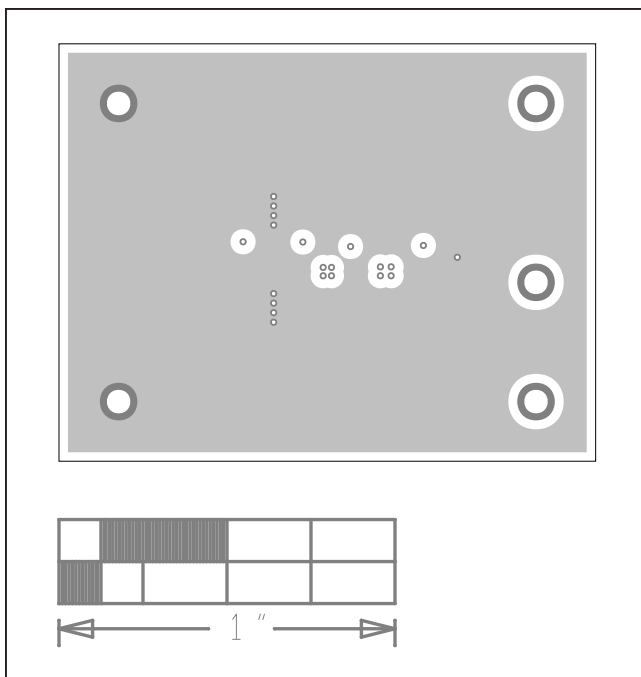

MAX17227A EV System PCB Layout—Internal1

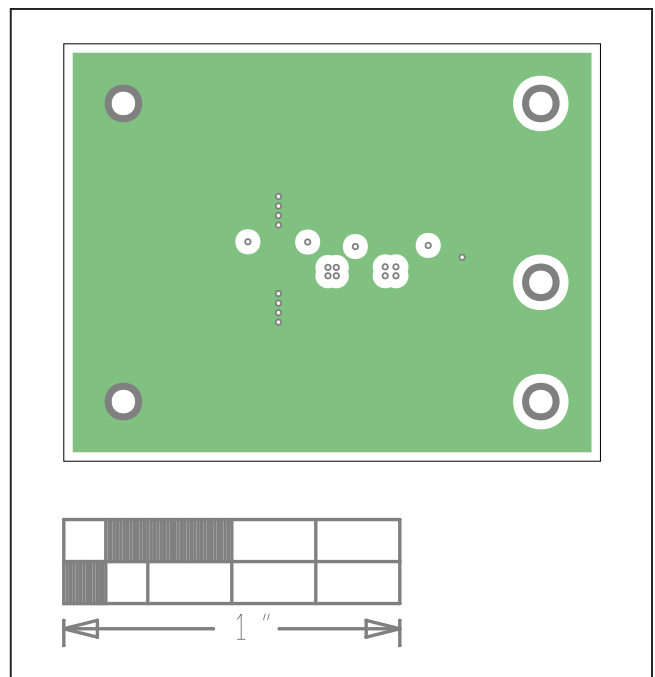

MAX17227A EV System PCB Layout—Internal2

**Essential Analog
Efficient Power Toolkit**

Used with: MAXM38643/MAX38640/
MAX77839/MAXM17225/MAX17227A/
MAX38889/MAX38902C/MAX38913/
MAX77827

MAX17227A PCB Layouts (continued)

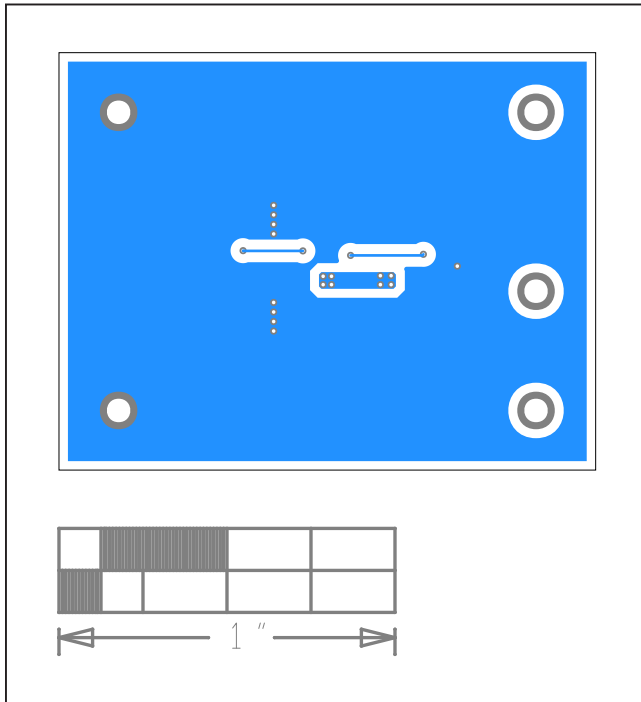

MAX17227A EV System PCB Layout—Bottom

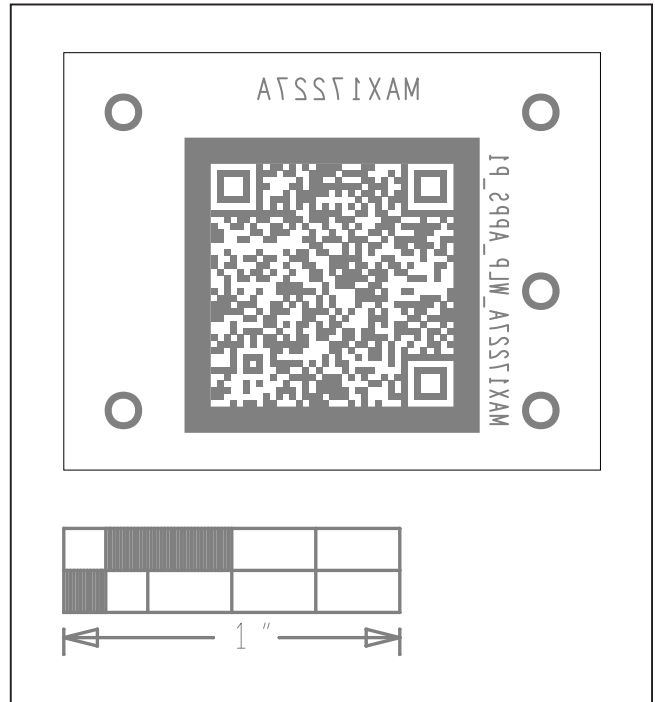

MAX17227A EV System PCB Layout—Bottom Silkscreen

[BACK TO TABLE OF CONTENTS](#)

Essential Analog Efficient Power Toolkit

Used with: MAXM38643/MAX38640/
MAX77839/MAXM17225/MAX17227A/
MAX38889/MAX38902C/MAX38913/
MAX77827

MAX38889

The MAX38889 is featured in the efficient power edition of the Essential Analog toolkit, MAXESSENTIAL02EP#. This small board provides a quick examination and testing of the MAX38889, 2.5V–5.5V, 3A reversible buck/boost

regulator for backup power applications. The board design and layout follow standard part recommendations. Refer to the product data sheet at www.maximintegrated.com/max38889 for more information. Use the product evaluation kit to examine the product thoroughly.

MAX38889 Bill of Materials

ITEM	REF_DES	DNI/DNP	QTY	MFG PART #	MANUFACTURER	VALUE	DESCRIPTION
1	BKB, RDY, VCAP, VSYS2	-	4	5002	KEystone	N/A	TEST POINT; PIN DIA=0.1IN; TOTAL LENGTH=0.3IN; BOARD HOLE=0.04IN; WHITE; PHOSPHOR BRONZE WIRE SILVER;
2	C1, C6, C7	-	3	GCM31CR71A226KE02	MURATA	22UF	CAP; SMT (1206); 22UF; 10%; 10V; X7R; CERAMIC
3	C2	-	1	SCCQ15B125SR	AVX	1.2F	CAP; THROUGH HOLE-RADIAL LEAD; 1.2F; +30%/-10%; 2.7V; N/A; ELECTRIC DOUBLE LAYER CAPACITOR
4	C3	-	1	C0603C474K4RAC; GRM188R71C474K; EMK107B7474KA; C1608X7R1C474K080AC	KEMET;MURATA; TAIYO YUDEN;TDK	0.47UF	CAP; SMT (0603); 0.47UF; 10%; 16V; X7R; CERAMIC
5	C4, C5	-	2	GRM32ER71A476KE15; 1210ZC476KAT2A	MURATA;AVX	47UF	CAP; SMT (1210); 47UF; 10%; 10V; X7R; CERAMIC
6	C8	-	1	C0603C105K4RAC; C1608X7R1C105K080AC; EMK107B7105KA; CGA3E1X7R1C105K080AC; 0603YC105KAT2A	KEMET;MURATA;TDK; TAIYO YUDEN;TDK;AVX	1UF	CAP; SMT (0603); 1UF; 10%; 16V; X7R; CERAMIC
7	C11	-	1	C0603C222K1RAC	KEMET	2200PF	CAP; SMT (0603); 2200PF; 10%; 100V; X7R; CERAMIC
8	L1	-	1	DFE252012F-R47M	MURATA	0.47UH	INDUCTOR; SMT (1008); METAL; 0.47UH; 20%; 4.9A
9	PGND1, PGND2	-	2	5001	KEystone	N/A	TEST POINT; PIN DIA=0.1IN; TOTAL LENGTH=0.3IN; BOARD HOLE=0.04IN; BLACK; PHOSPHOR BRONZE WIRE SILVER PLATE FINISH;
10	R1	-	1	CRCW0603499KFK; ERJ-3EKF4993; RC0603FR-07499KL	VISHAY DALE; PANASONIC;YAGEO	499K	RES; SMT (0603); 499K; 1%; +/-100PPM/DEGC; 0.1000W
11	R2	-	1	CRCW06034023FK; ERJ-3EKF4023	VISHAY;PANASONIC	402K	RES; SMT (0603); 402K; 1%; +/-100PPM/DEGC; 0.1000W
12	R3, R6	-	2	CRCW06031M82FK	VISHAY	1.82M	RES; SMT (0603); 1.82M; 1%; +/-100PPM/DEGC; 0.1000W
13	R4	-	1	CRCW060333K0FK	VISHAY DALE	33K	RES; SMT (0603); 33K; 1%; +/-100PPM/DEGC; 0.1000W
14	R5	-	1	CRCW06031M21FK	VISHAY	1.21M	RES; SMT (0603); 1.21M; 1%; +/-100PPM/DEGC; 0.1000W
15	R7, R8	-	2	CRCW06031M00JN	VISHAY DALE	1M	RES; SMT (0603); 1M; 5%; +/-200PPM/DEGC; 0.1000W
16	R10	-	1	CRCW2512100RFK	VISHAY DALE	100	RES; SMT (2512); 100; 1%; +/-100PPM/DEGC; 1W
17	R11	-	1	MCR03EZPFX2002; ERJ-3EKF2002; CRO603-FX-2002ELF; CRCW060320K0FK	ROHM;PANASONIC; BOURNS;VISHAY DALE	20K	RES; SMT (0603); 20K; 1%; +/-100PPM/DEGC; 0.1000W
18	U1	-	1	MAX38889AATE+	MAXIM	MAX38889AATE+	IC; REG; REVERSIBLE BUCK/BOOST REGULATOR; TQFN16-EP
19	PCB	-	1	MAX38889A_TQFN_APPS_P1	MAXIM	PCB	PCB:MAX38889A_TQFN_APPS_P1
20	R9	DNP	0	N/A	N/A	OPEN	RESISTOR; 0603; OPEN; FORMFACTOR
TOTAL			28				

MAX38889 Schematic

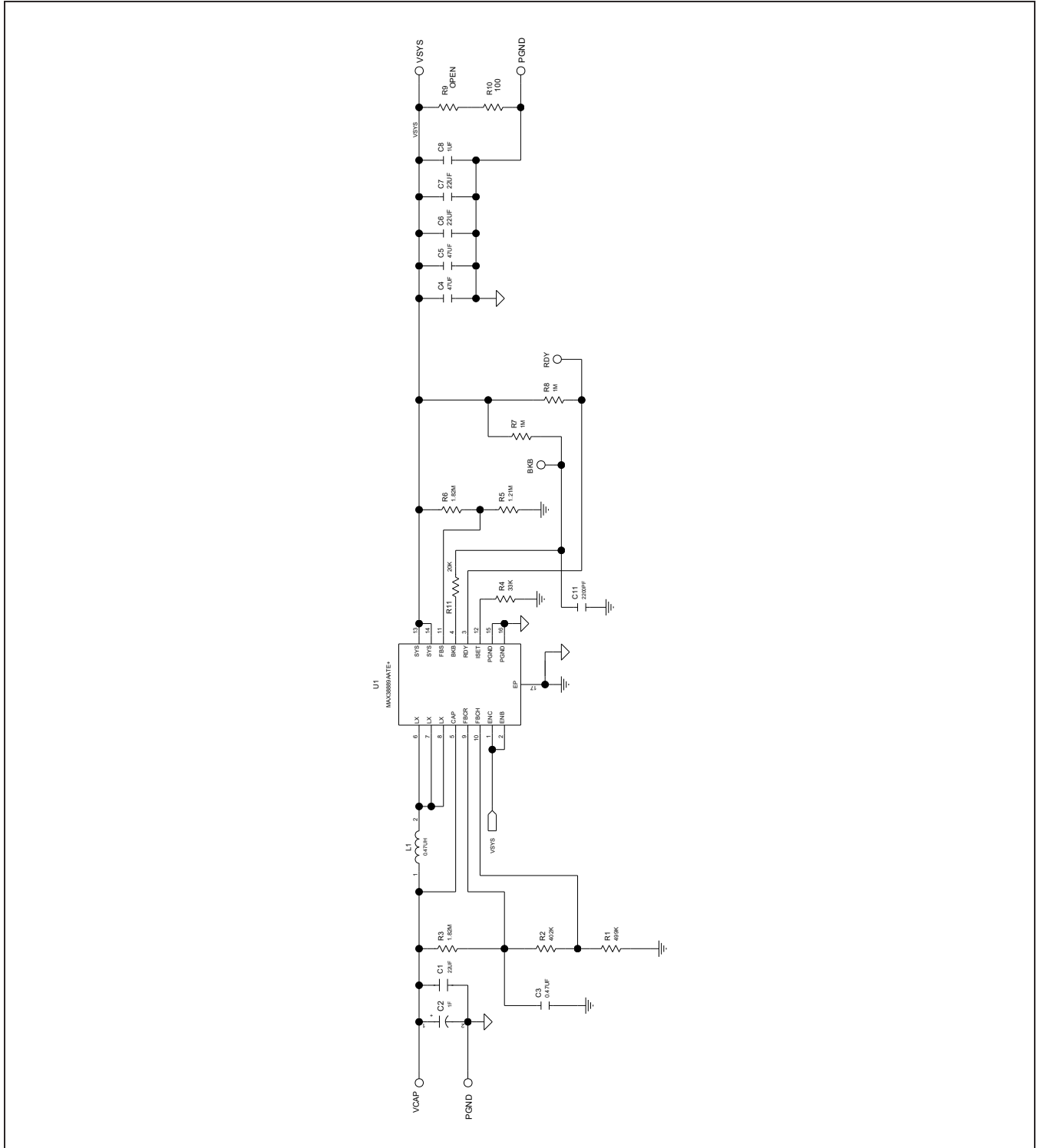

Essential Analog Efficient Power Toolkit

Used with: MAXM38643/MAX38640/
MAX77839/MAXM17225/MAX17227A/
MAX38889/MAX38902C/MAX38913/
MAX77827

MAX38889 PCB Layouts

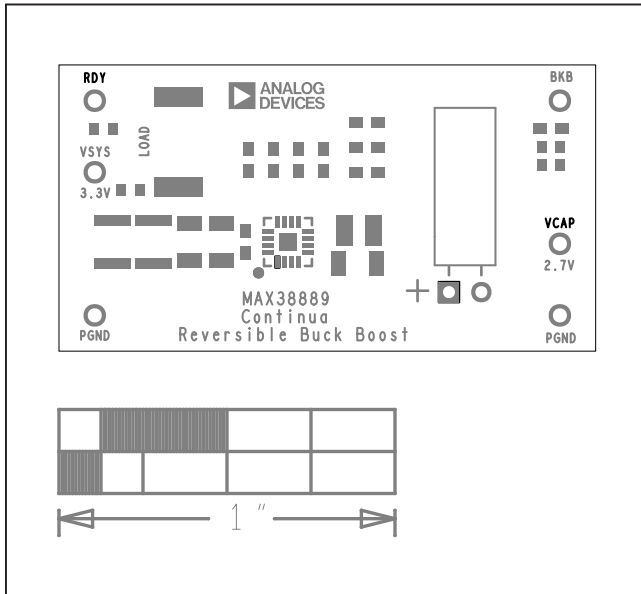

MAX38889 EV System Component Placement Guide—Top Silkscreen

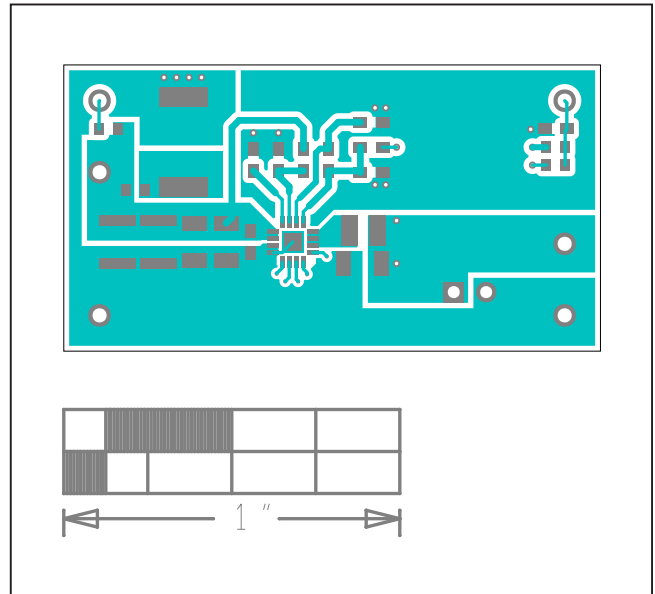

MAX38889 EV System PCB Layout—Top

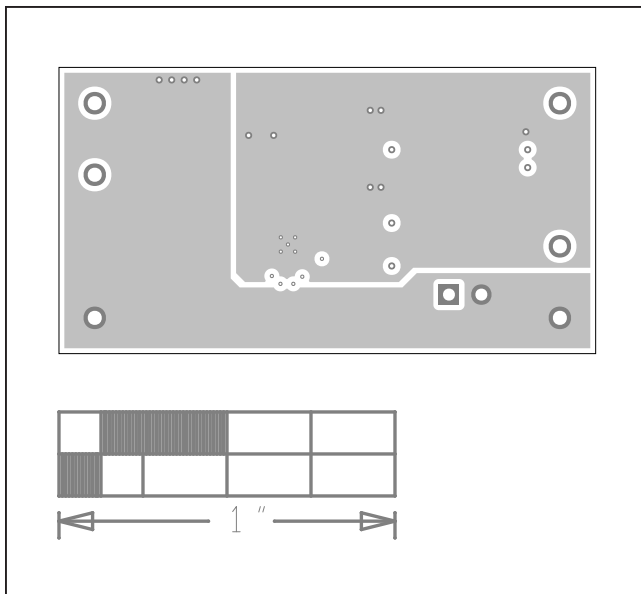

MAX38889 EV System PCB Layout—Internal1

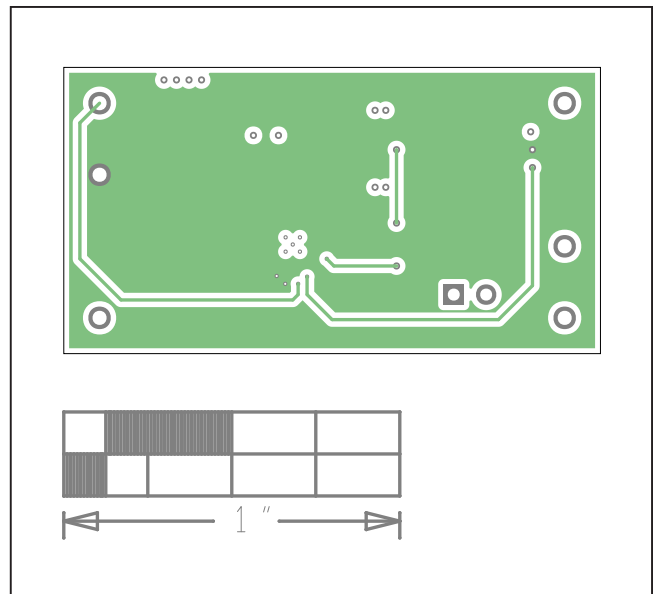

MAX38889 EV System PCB Layout—Internal2

**Essential Analog
Efficient Power Toolkit**

Used with: MAXM38643/MAX38640/
MAX77839/MAXM17225/MAX17227A/
MAX38889/MAX38902C/MAX38913/
MAX77827

MAX38889 PCB Layouts (continued)

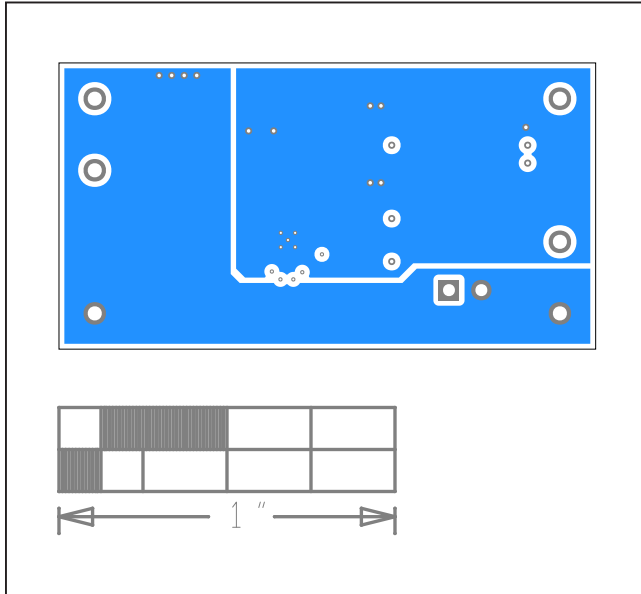

MAX38889 EV System PCB Layout—Bottom

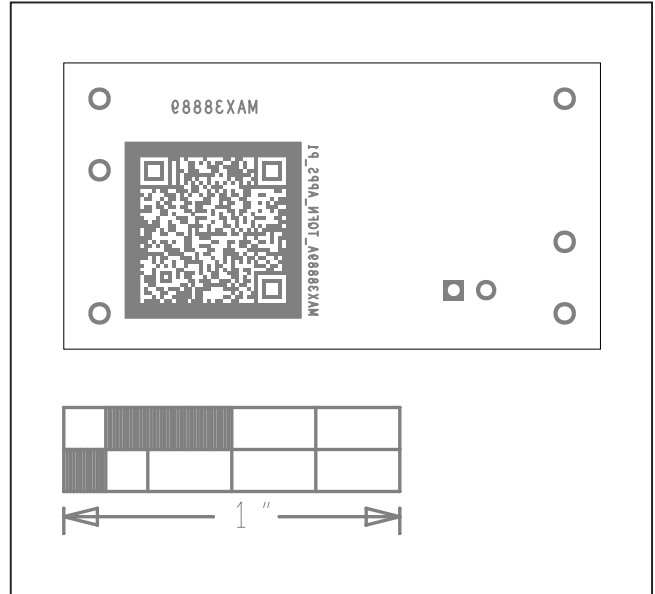

MAX38889 EV System PCB Layout—Bottom Silkscreen

[BACK TO TABLE OF CONTENTS](#)

Essential Analog Efficient Power Toolkit

Used with: MAXM38643/MAX38640/
MAX77839/MAXM17225/MAX17227A/
MAX38889/MAX38902C/MAX38913/
MAX77827

MAX38902C

The MAX38902C is featured in the efficient power edition of the Essential Analog toolkit, MAXESSENTIAL02EP#. This small board provides a quick examination and testing of the MAX38902C, 10.5µV_{RMS} Low Noise 500mA

LDO Linear Regulator. The board design and layout follow standard part recommendations. Refer to the product data sheet at www.maximintegrated.com/max38902C for more information. Use the product evaluation kit to examine the product thoroughly.

MAX38902C Bill of Materials

ITEM	QTY	REF DES	MFG PART #	MANUFACTURER	VALUE	DESCRIPTION
1	1	C1	C1608C0G1H103J080AA; CGA3E2C0G1H103J080AD; GRM1885C1H103JA01	TDK;TDK;MURATA	0.01UF	CAP; SMT (0603); 0.01UF; 5%; 50V; COG; CERAMIC
2	2	C2, C3	GMC10X7R475K6R3NT; CL10B475KQ8NQD; JMK107BB7475KA; CL10B475KQ8NQNC; 06036C475KAT2A	CAL-CHIP ELECTRONIC INC.; SAMSUNG;TAIYO YUDEN; SAMSUNG;AVX	4.7UF	CAP; SMT (0603); 4.7UF; 10%; 6.3V; X7R; CERAMIC; NOTE: NOT RECOMMENDED FOR NEW DESIGN. USE 20-004u7-16
3	1	R1	CRCW0603909KFK	VISHAY DALE	909K	RES; SMT (0603); 909K; 1%; +/-100PPM/DEGK; 0.1000W
4	1	R2	CRCW0603200KFK	VISHAY DALE	200K	RES; SMT (0603); 200K; 1%; +/-100PPM/DEGC; 0.1000W
5	1	R10	RC0402JR-070RL; CR0402-16W-000RJT	YAGEO PHYCOMP; VENKEL LTD.	0	RES; SMT (0402); 0; 5%; JUMPER; 0.0630W
6	1	U1	MAX38902C-ANT+	MAXIM	MAX38902C-ANT+	EVKIT PART - IC; MAX38902C-ANT+; WLP6; PACKAGE OUTLINE DEVICE: 21-100055; PKG. CODE: N60C1+1
7	1	PCB	MAX38902C_WLP_APPS_P1	MAXIM	PCB	PCB:MAX38902C_WLP_APPS_P1
TOTAL	8					

DO NOT PURCHASE(DNP)

ITEM	QTY	REF DES	MFG PART #	MANUFACTURER	VALUE	DESCRIPTION
1	2	R12, R11	N/A	N/A	OPEN	RESISTOR; 0402; OPEN; FORMFACTOR
2	3	TP1-TP3	5002	KEYSTONE	N/A	TEST POINT; PIN DIA=0.1IN; TOTAL LENGTH=0.3IN; BOARD HOLE=0.04IN; WHITE; PHOSPHOR BRONZE WIRE SILVER; NOT FOR COLD TEST
3	2	TP4, TP5	5001	KEYSTONE	N/A	TEST POINT; PIN DIA=0.1IN; TOTAL LENGTH=0.3IN; BOARD HOLE=0.04IN; BLACK; PHOSPHOR BRONZE WIRE SILVER PLATE FINISH; RECOMMENDED FOR BOARD THICKNESS=0.062IN; NOT FOR COLD TEST
TOTAL	7					

MAX38902C Schematic

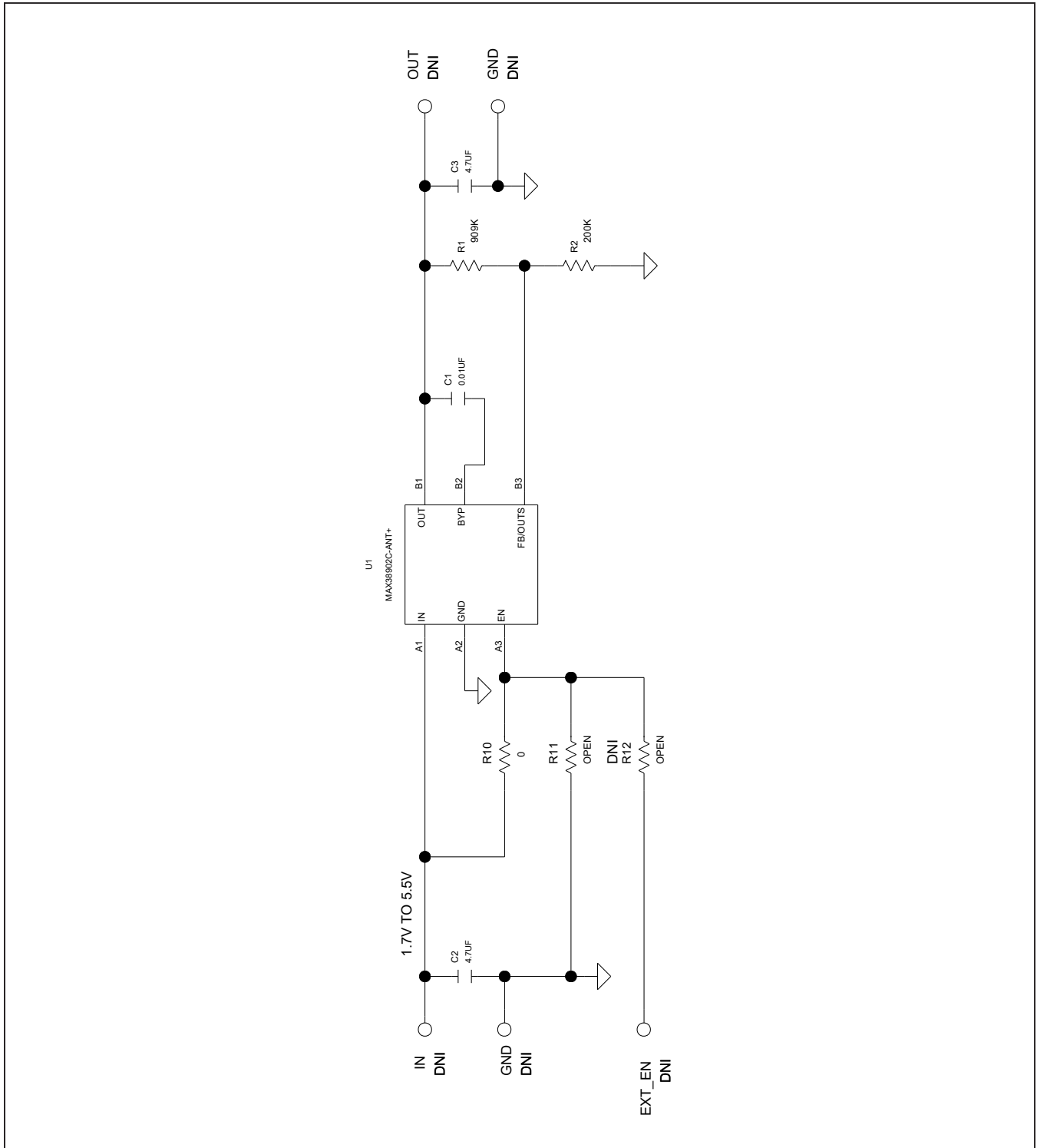

**Essential Analog
Efficient Power Toolkit**

Used with: MAXM38643/MAX38640/
MAX77839/MAXM17225/MAX17227A/
MAX38889/MAX38902C/MAX38913/
MAX77827

MAX38902C PCB Layouts

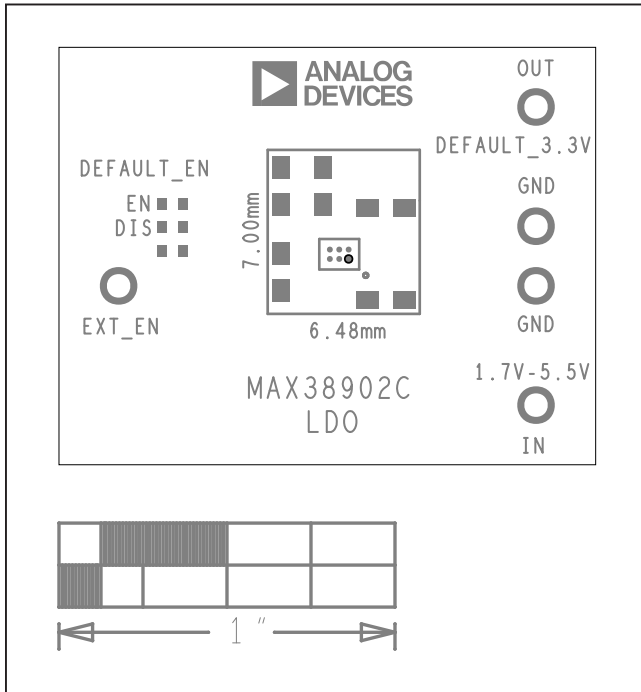

MAX38902C EV System Component Placement Guide—Top Silkscreen

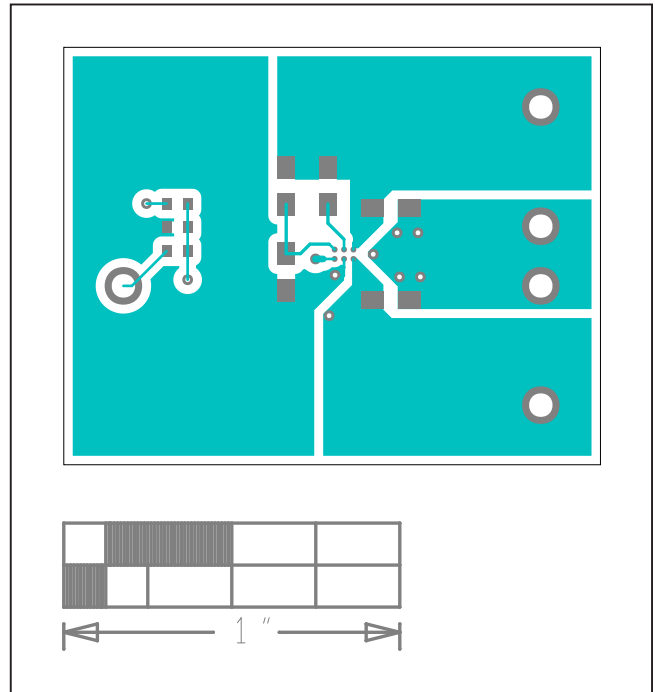

MAX38902C EV System PCB Layout—Top

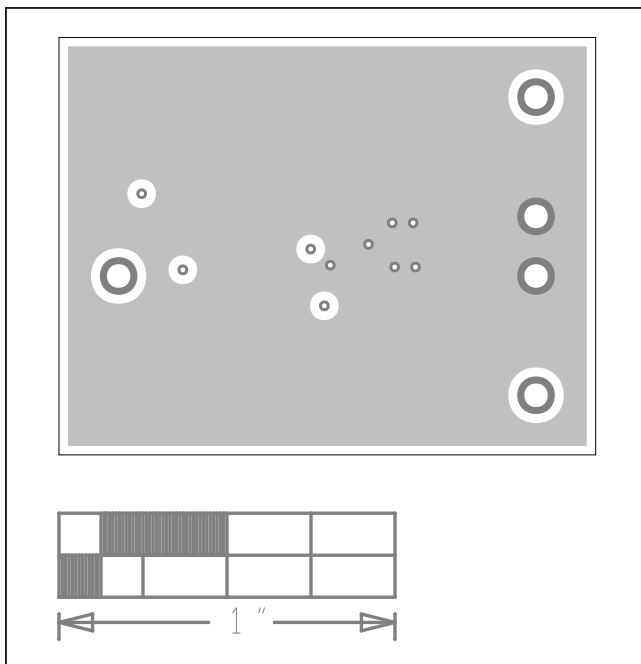

MAX38902C EV System PCB Layout—Internal1

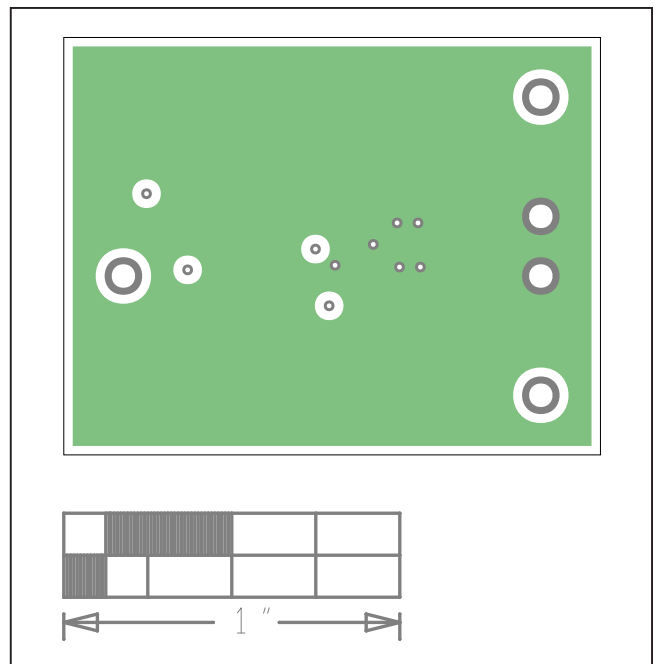

MAX38902C EV System PCB Layout—Internal2

**Essential Analog
Efficient Power Toolkit**

Used with: MAXM38643/MAX38640/
MAX77839/MAXM17225/MAX17227A/
MAX38889/MAX38902C/MAX38913/
MAX77827

MAX38902C PCB Layouts (continued)

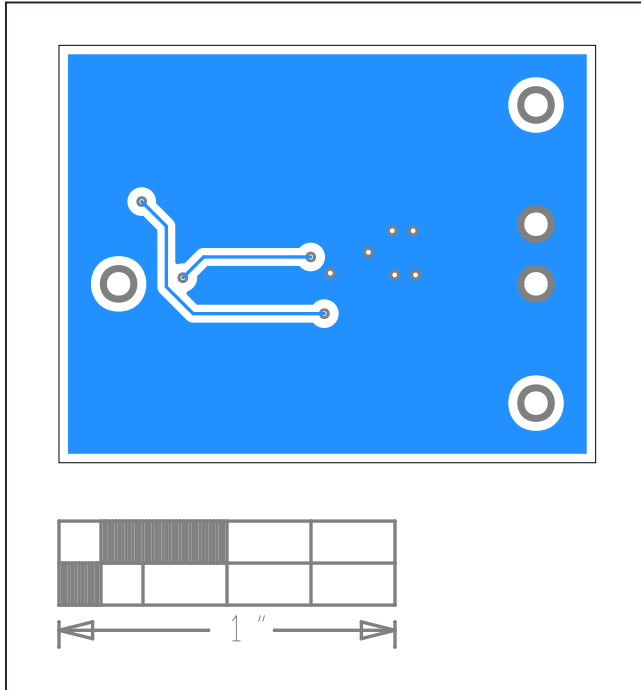

MAX38902C EV System PCB Layout—Bottom

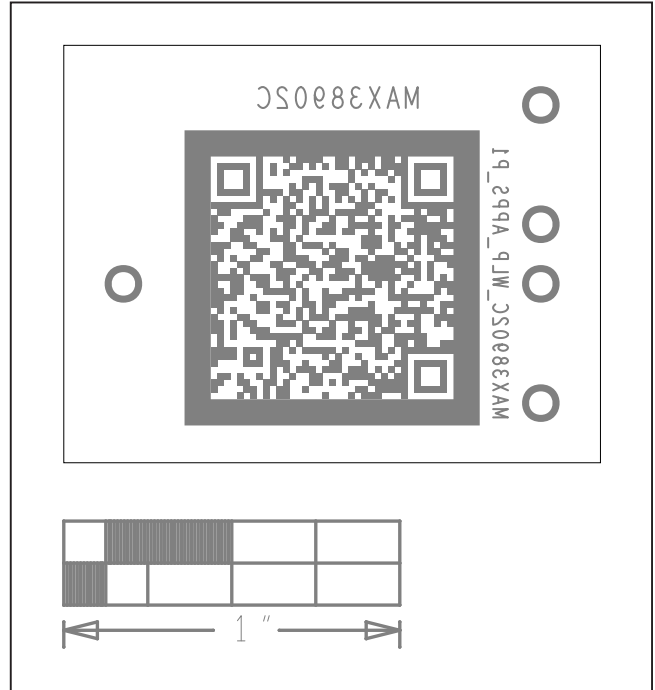

MAX38902C EV System PCB Layout—Bottom Silkscreen

[BACK TO TABLE OF CONTENTS](#)

Essential Analog Efficient Power Toolkit

Used with: MAXM38643/MAX38640/
MAX77839/MAXM17225/MAX17227A/
MAX38889/MAX38902C/MAX38913/
MAX77827

MAX38913

The MAX38913 is featured in the efficient power edition of the Essential Analog toolkit, MAXESSENTIAL02EP#. This small board provides a quick examination and testing of the MAX38913, $4\mu\text{V}_{\text{RMS}}$ Ultra-Low-Noise

1A LDO with two-level output voltage selection. The board design and layout follow standard part recommendations. Refer to the product data sheet at www.maximintegrated.com/max38913 for more information. Use the product evaluation kit to examine the product thoroughly.

MAX38913 Bill of Materials

ITEM	REF_DES	DNI/DNP	QTY	MFG PART #	MANUFACTURER	VALUE	DESCRIPTION
1	C1	-	1	C1005X7R1H473K	TDK	0.047UF	CAP; SMT (0402); 0.047UF; 10%; 50V; X7R; CERAMIC
2	C2	-	1	GCM31CR71A226KE02	MURATA	22UF	CAP; SMT (1206); 22UF; 10%; 10V; X7R; CERAMIC
3	C3	-	1	GRM31CR60J107KE39	MURATA	100UF	CAP; SMT (1206); 100UF; 10%; 6.3V; X5R; CERAMIC
4	GND_1, GND_2	-	2	5001	KEYSTONE	N/A	TEST POINT; PIN DIA=0.1IN; TOTAL LENGTH=0.3IN; BOARD HOLE=0.04IN; BLACK; PHOSPHOR BRONZE WIRE SILVER PLATE FINISH;
5	R2	-	1	CRCW060380K6FK	VISHAY DALE	80.6K	RES; SMT (0603); 80.6K; 1%; +/-100PPM/DEGC; 0.1000W
6	R5, R7	-	2	RC0402JR-070RL; CR0402-16W-000RJT	YAGEO PHYCOMP; VENKEL LTD.	0	RES; SMT (0402); 0; 5%; JUMPER; 0.0630W
7	TP_EN1, TP_EN2, TP_RSEL1, TP_RSEL2	-	4	5002	KEYSTONE	N/A	TEST POINT; PIN DIA=0.1IN; TOTAL LENGTH=0.3IN; BOARD HOLE=0.04IN; WHITE; PHOSPHOR BRONZE WIRE SILVER;
8	U1	-	1	MAX38913AANC+	MAXIM	MAX38913AANC+	EVKIT PART - IC; MAX38913AANC+; 1A LOW NOISE LDO WITH DUAL VOLTAGE AND BYPASS; PACKAGE OUTLINE DRAWING: 21-100500; PACKAGE CODE: N121E1+1
9	PCB	-	1	MAX38913A_WLP_APPS_P1	MAXIM	PCB	PCB:MAX38913A_WLP_APPS_P1
10	TP_IN, TP_OUT	DNP	0	5002	KEYSTONE	N/A	TEST POINT; PIN DIA=0.1IN; TOTAL LENGTH=0.3IN; BOARD HOLE=0.04IN; WHITE; PHOSPHOR BRONZE WIRE SILVER;
11	R1	DNP	0	N/A	N/A	OPEN	RESISTOR; 0603; OPEN; FORMFACTOR
12	R3, R4, R6, R8	DNP	0	N/A	N/A	OPEN	RESISTOR; 0402; OPEN; FORMFACTOR
TOTAL			14				

MAX38913 Schematic

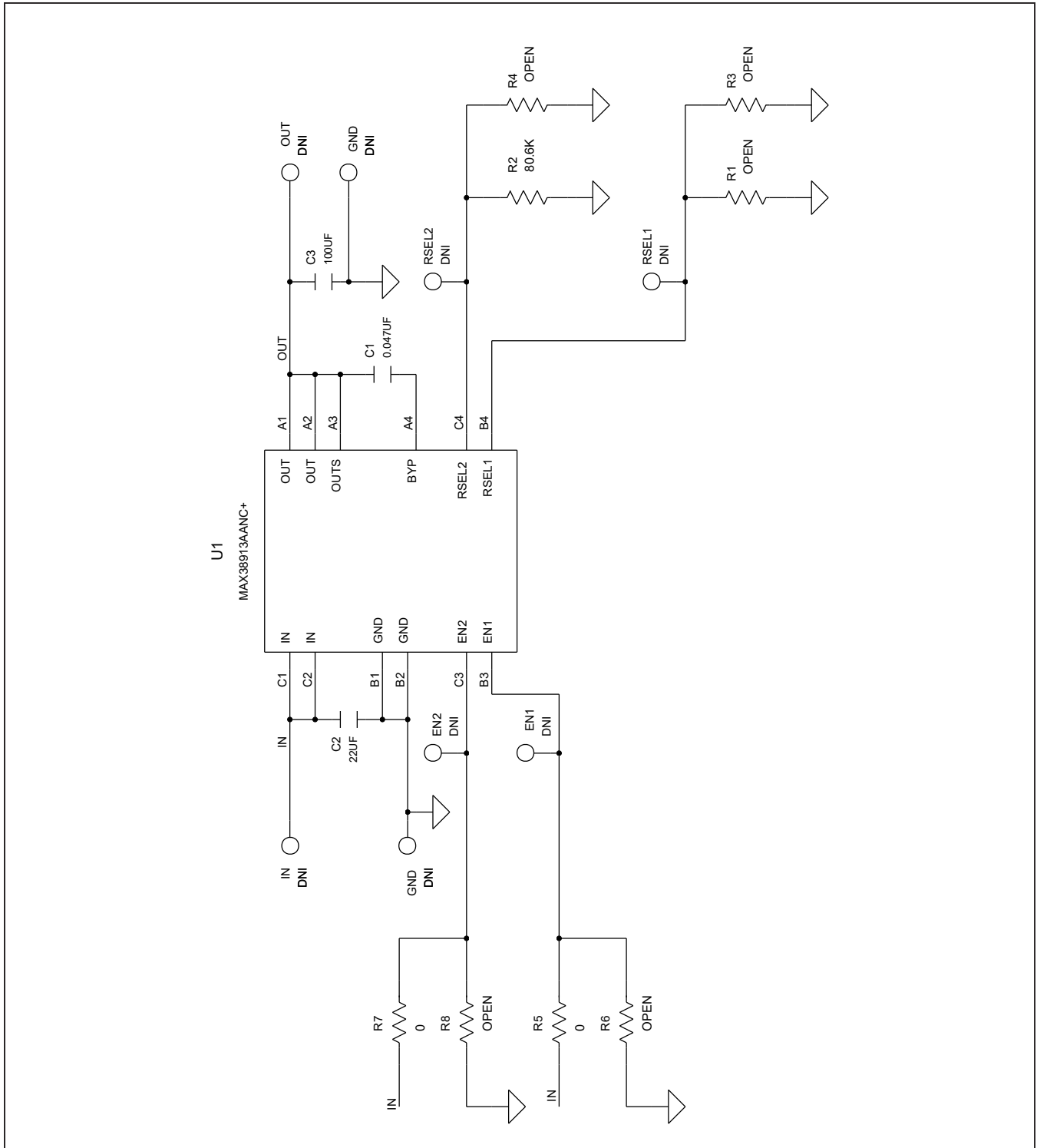

Essential Analog Efficient Power Toolkit

Used with: MAXM38643/MAX38640/
MAX77839/MAXM17225/MAX17227A/
MAX38889/MAX38902C/MAX38913/
MAX77827

MAX38913 PCB Layouts

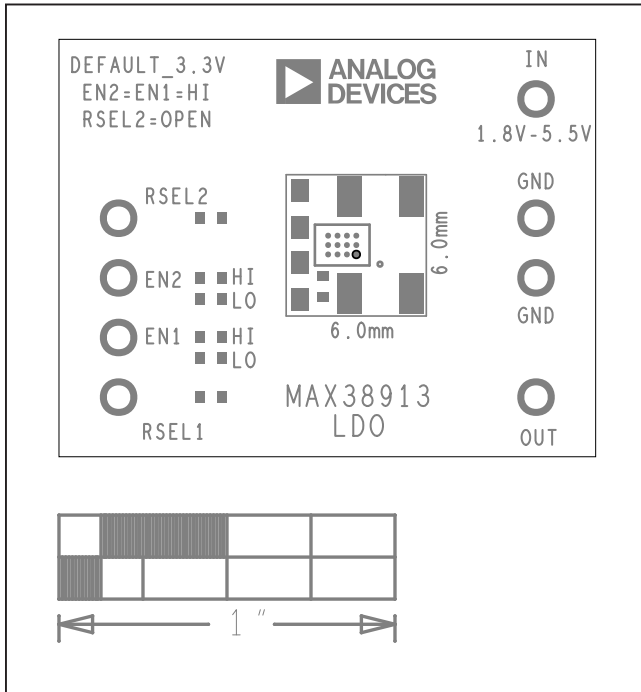

MAX38913 EV System Component Placement Guide—Top Silkscreen

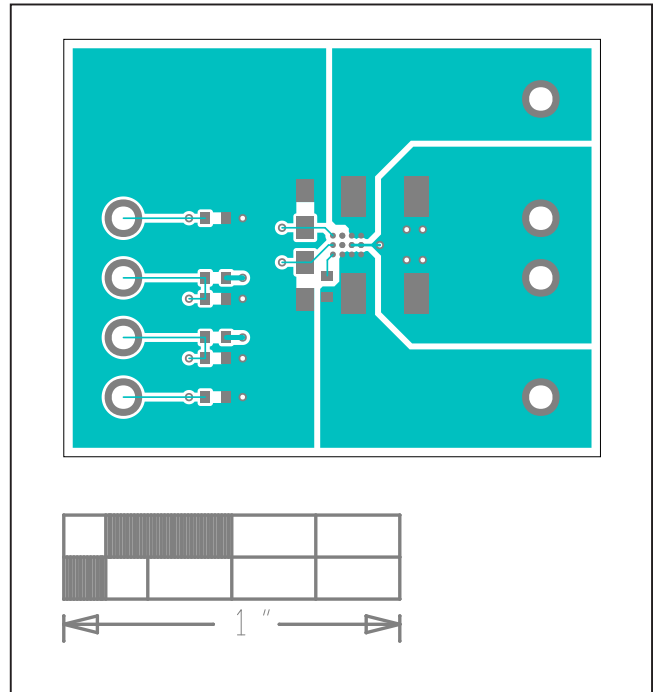

MAX38913 EV System PCB Layout—Top

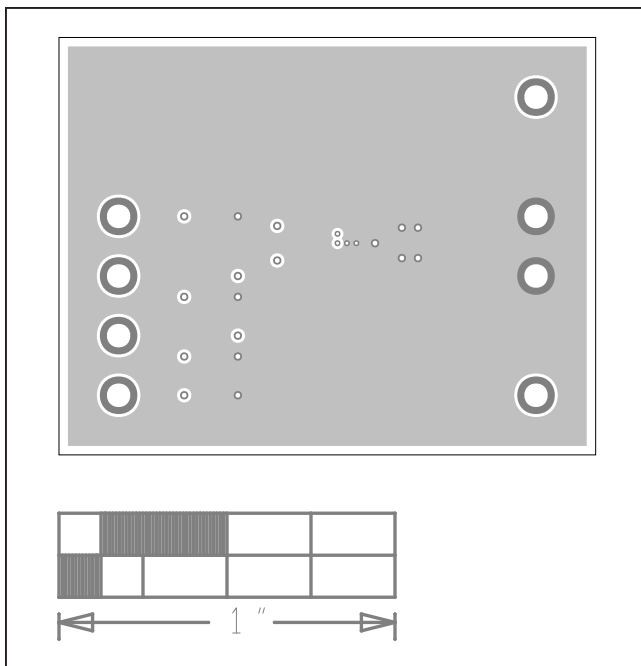

MAX38913 EV System PCB Layout—Internal1

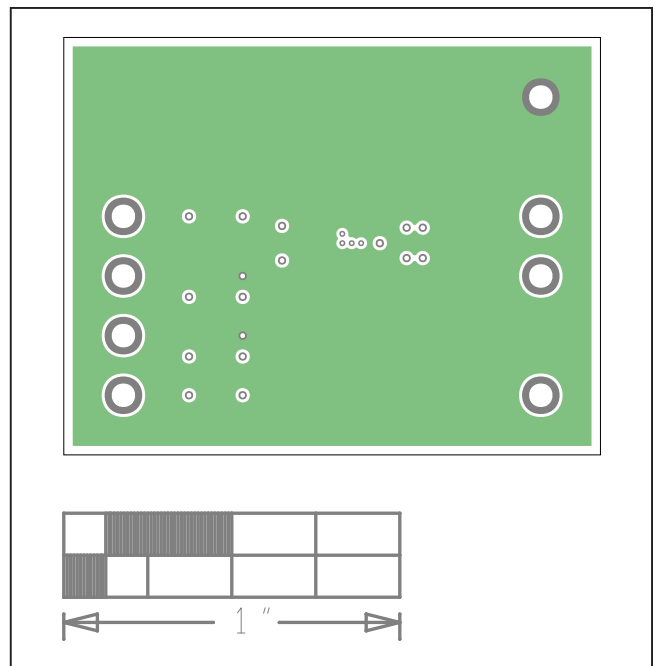

MAX38913 EV System PCB Layout—Internal2

**Essential Analog
Efficient Power Toolkit**

Used with: MAXM38643/MAX38640/
MAX77839/MAXM17225/MAX17227A/
MAX38889/MAX38902C/MAX38913/
MAX77827

MAX38913 PCB Layouts (continued)

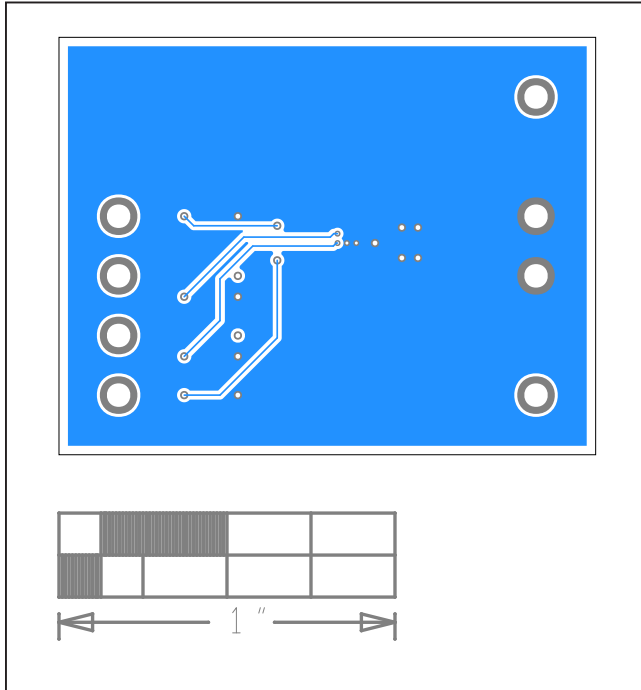

MAX38913 EV System PCB Layout—Bottom

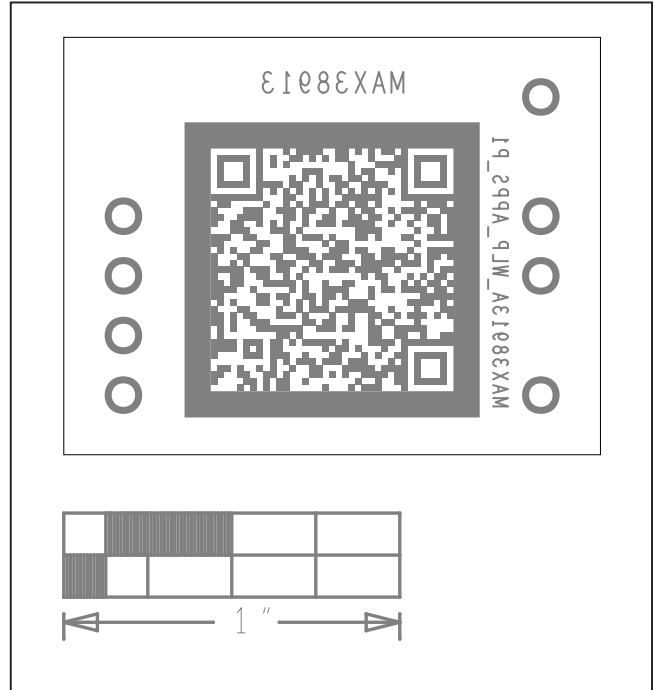

MAX38913 EV System PCB Layout—Bottom Silkscreen

[BACK TO TABLE OF CONTENTS](#)

Essential Analog Efficient Power Toolkit

Used with: MAXM38643/MAX38640/
MAX77839/MAXM17225/MAX17227A/
MAX38889/MAX38902C/MAX38913/
MAX77827

MAX77827A

The MAX77827A is featured in the efficient power edition of the Essential Analog toolkit, MAXESSENTIAL02EP#. This small board provides a quick examination and testing of the MAX77827A, 5.5V Input, 1.8A/3.1A switch

buck-boost converter with 6µA IQ. The board design and layout follow standard part recommendations. Refer to the product data sheet at www.maximintegrated.com/max77827 for more information. Use the product evaluation kit to examine the product thoroughly.

MAX77827A Bill of Materials

ITEM	QTY	REF DES	MFG PART #	MANUFACTURER	VALUE	DESCRIPTION
1	1	C1	C1608X5R1A106K080AC	TDK	10UF	CAP; SMT (0603); 10UF; 10%; 10V; X5R; CERAMIC
2	1	C2	GRM155R70J105MA12	MURATA	1UF	CAP; SMT (0402); 1UF; 20%; 6.3V; X7R; CERAMIC
3	1	C3	C1608X5R1A226M080AC; GRM188R61A226ME15	TDK;MURATA	22UF	CAP; SMT (0603); 22UF; 20%; 10V; X5R; CERAMIC
4	1	L1	CIGT201610EH1R0MN	SAMSUNG	1UH	INDUCTOR; SMT (0806); COMPOSITE; 1UH; 20%; 4.3A
5	2	R1, R2	RC0402JR-070RL; CR0402-16W-000RJT	YAGEO PHYCOMP; VENKEL LTD.		0 RES; SMT (0402); 0; 5%; JUMPER; 0.0630W
6	1	R5	CRCW0402100KFK; RC0402FR-07100KL	VISHAY;YAGEO	100K	RES; SMT (0402); 100K; 1%; +/-100PPM/DEGC; 0.0630W
7	1	U1	MAX77827AEWC+	MAXIM	MAX77827AEWC+	IC; CONV; 5.5V INPUT; 1.8A/3.1A SWITCH BUCK-BOOST CONVERTER WITH 6MICROAMP IQ; WLP12
8	1	PCB	MAX77827_WLP_APPS_P1	MAXIM	PCB	PCB:MAX77827_WLP_APPS_P1
TOTAL	9					

DO NOT PURCHASE(DNP)

ITEM	QTY	REF DES	MFG PART #	MANUFACTURER	VALUE	DESCRIPTION
1	2	J1, J2	PCC03SAAN	SULLINS	PCC03SAAN	CONNECTOR; MALE; THROUGH HOLE; BREAKAWAY; STRAIGHT THROUGH; 3PINS; -65 DEGC TO +125 DEGC
2	2	R4, R6	RC0402JR-070RL; CR0402-16W-000RJT	YAGEO PHYCOMP; VENKEL LTD.		0 RES; SMT (0402); 0; 5%; JUMPER; 0.0630W
3	1	R3	N/A	N/A	OPEN	RESISTOR; 0402; OPEN; FORMFACTOR
TOTAL	5					

MAX77827A Schematic

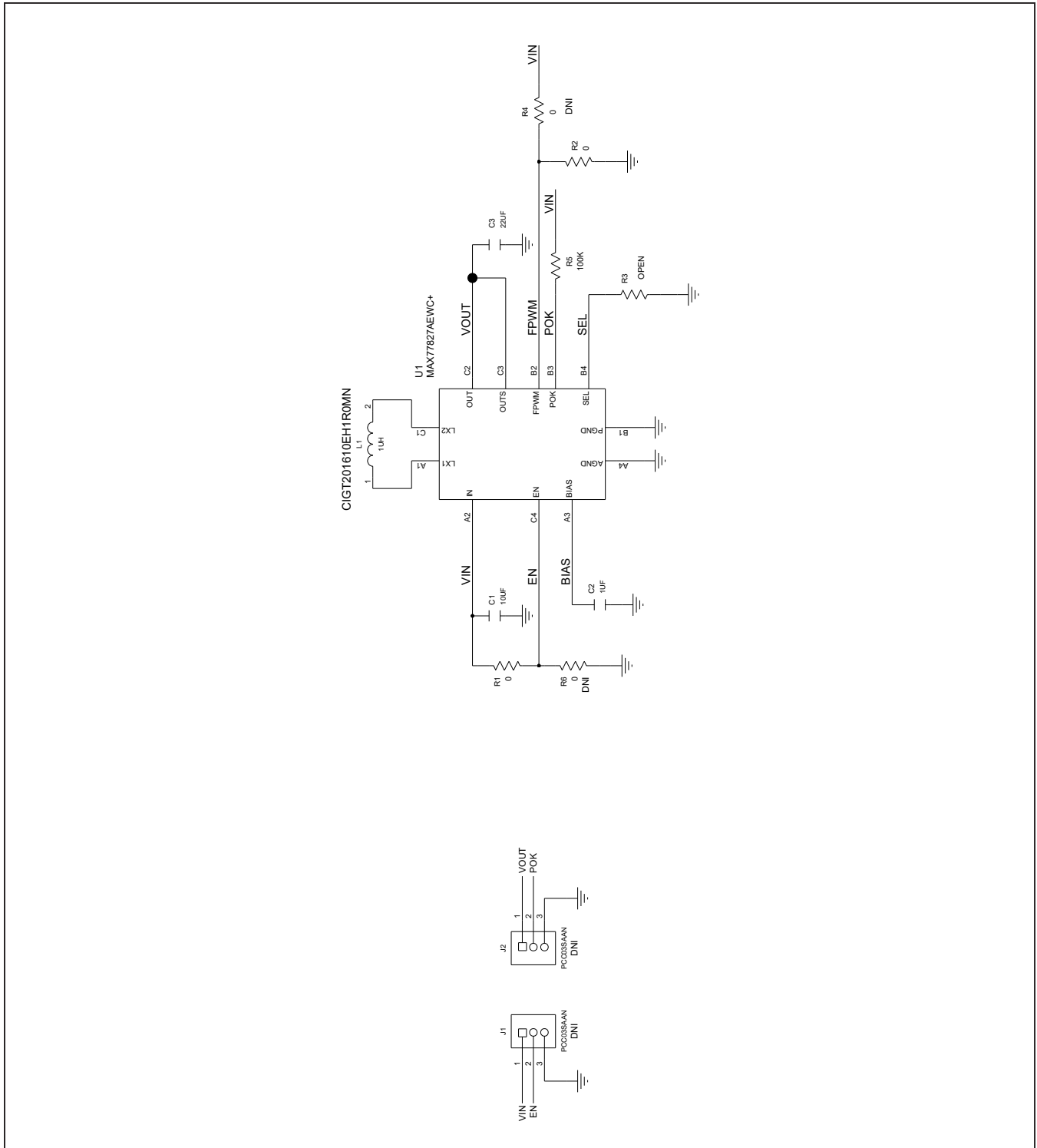

**Essential Analog
Efficient Power Toolkit**

Used with: MAXM38643/MAX38640/
MAX77839/MAXM17225/MAX17227A/
MAX38889/MAX38902C/MAX38913/
MAX77827

MAX77827A PCB Layouts

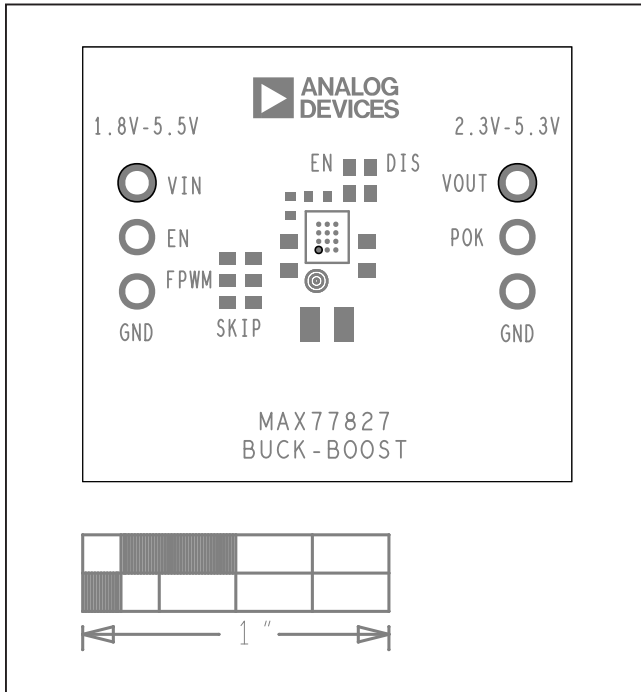

MAX77827A EV System Component Placement Guide—Top Silkscreen

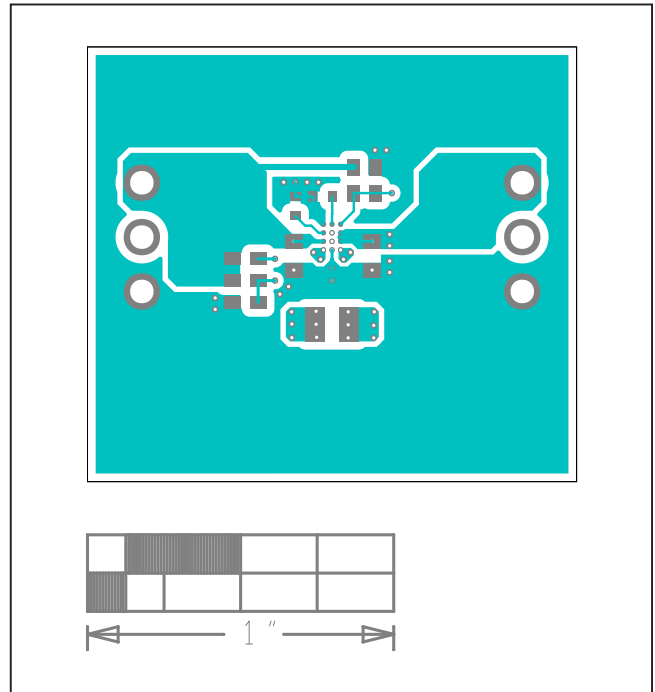

MAX77827A EV System PCB Layout—Top

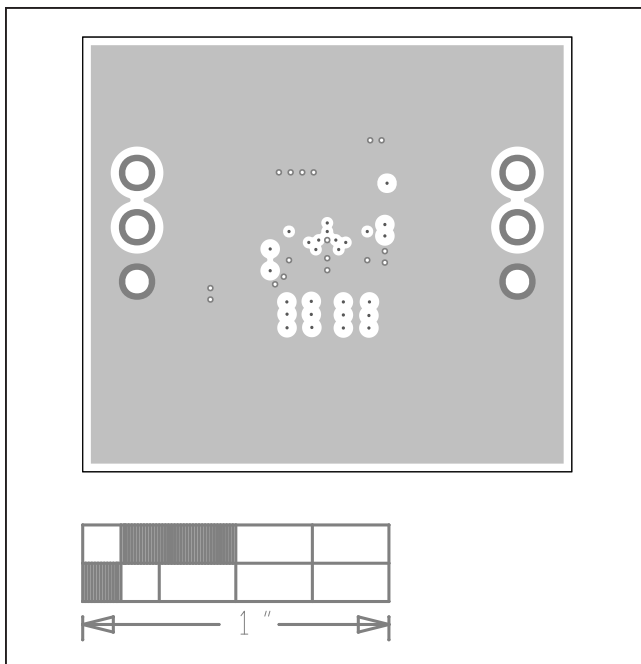

MAX77827A EV System PCB Layout—Internal2

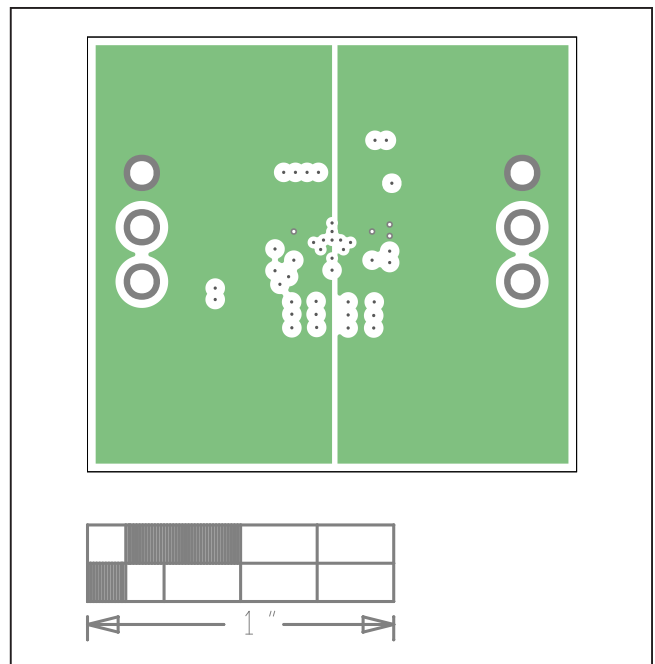

MAX77827A EV System PCB Layout—Internal3

**Essential Analog
Efficient Power Toolkit**

Used with: MAXM38643/MAX38640/
MAX77839/MAXM17225/MAX17227A/
MAX38889/MAX38902C/MAX38913/
MAX77827

MAX77827A PCB Layouts (continued)

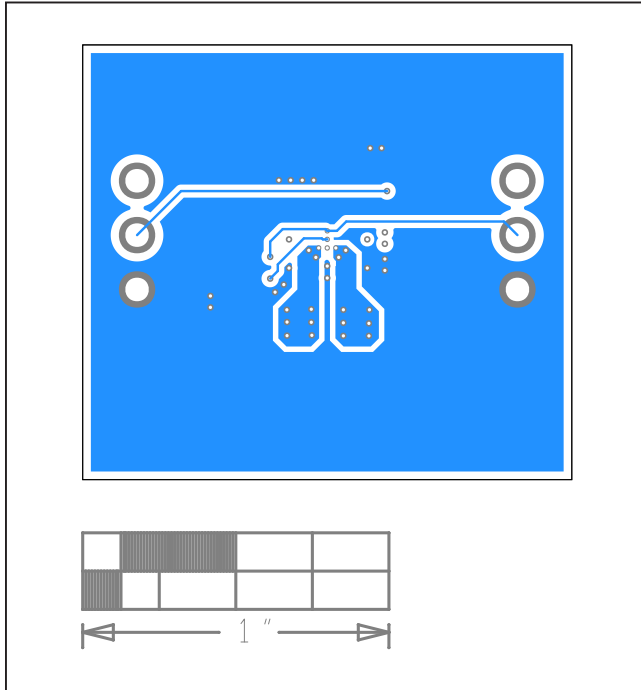

MAX77827A EV System PCB Layout—Bottom

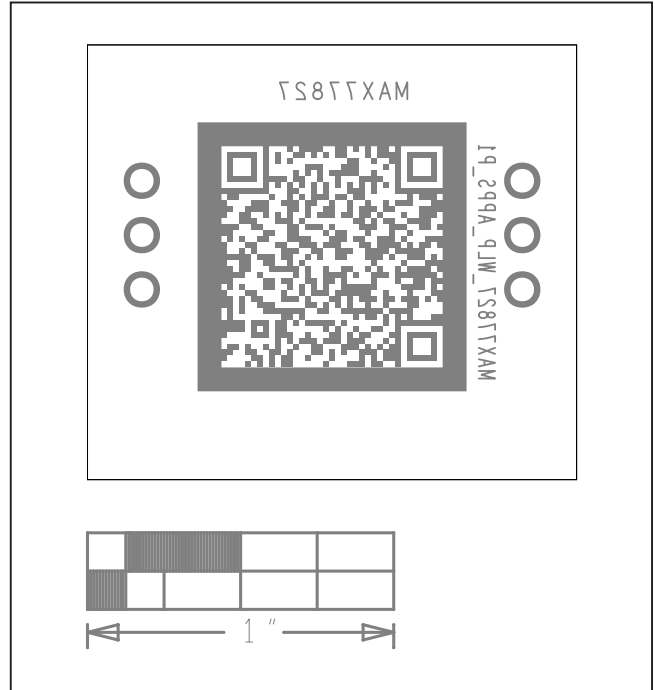

MAX77827A EV System PCB Layout—Bottom Silkscreen

[BACK TO TABLE OF CONTENTS](#)

Essential Analog Efficient Power Toolkit

Used with: MAXM38643/MAX38640/
MAX77839/MAXM17225/MAX17227A/
MAX38889/MAX38902C/MAX38913/
MAX77827

Ordering Information

PART	TYPE
MAXESSENTIAL02EP#	EV System

#Denotes RoHS compliance.

Essential Analog Efficient Power Toolkit

Used with: MAXM38643/MAX38640/
MAX77839/MAXM17225/MAX17227A/
MAX38889/MAX38902C/MAX38913/
MAX77827

Revision History

REVISION NUMBER	REVISION DATE	DESCRIPTION	PAGES CHANGED
0	3/22	Initial release	—
1	3/22	Updated DS title, MAXM38643A Bill of Materials, MAXM38643A Schematic, MAX38640A Bill of Materials, MAX38640A Schematic, MAX38889 Bill of Materials, MAX38889 Schematic, MAX38913 Bill of Materials, and MAX38913 Schematic	1, 4, 5, 8, 9, 24, 25, 32, 33



Information furnished by Analog Devices is believed to be accurate and reliable. However, no responsibility is assumed by Analog Devices for its use, nor for any infringements of patents or other rights of third parties that may result from its use. Specifications subject to change without notice. No license is granted by implication or otherwise under any patent or patent rights of Analog Devices. Trademarks and registered trademarks are the property of their respective owners.