

MAXM17546EVKITBE# 5V Output Evaluation Kit

Evaluates: MAXM17546 5V Output

General Description

The *Himalaya* series of voltage regulator ICs and power modules enable cooler, smaller, and simpler power-supply solutions. The MAXM17546EVKITBE# 5V-output evaluation kit (EV kit) is a demonstration circuit of the MAXM17546 42V, 5A high-efficiency, current-mode, synchronous step-down DC-DC switching power module. The EV kit operates over a wide input-voltage of 7.5V to 42V and provides up to 5A load current with a 5V-output voltage. The EV kit is programmed to switch at a frequency of 450kHz. The module is simple to use and easily configurable with minimal external components. It features cycle-by-cycle peak current-limit protection, under-voltage lockout (EN/UVLO), and thermal shutdown.

The EV kit comes with the compact 29-pin 15mm x 9mm x 4.32mm SiP package MAXM17546 module installed and is rated to operate over the full industrial -40°C to +125°C temperature range.

The MAXM17546 module data sheet provides a complete description of the part that should be read in conjunction with this data sheet prior to operating the EV kit. For full module features, benefits and parameters, refer to the MAXM17546 data sheet.

Features

- Wide 7.5V to 42V Input Range
- Highly Integrated Solution with Built-In Shielded Inductor
- Programmed 5V Output, Up To 5A Output Current
- All Ceramic Capacitors and Ultra-Compact Solution
- Selectable PWM, DCM, and PFM Modes
- Programmable 4ms Soft-Start Time and Prebias Startup
- Open-Drain $\overline{\text{RESET}}$ Output Pulled Up To 5V V_{CC}
- Programmable EN/UVLO Threshold
- Provision for External Frequency Synchronization
- Hiccup Overcurrent Protection (OCP)
- Overtemperature Protection (OTP)
- -40°C to +125°C Industrial Temperature Range
- Complies with CISPR22(EN55022) Class B Conducted and Radiated Emissions

Quick Start

Recommended Equipment

- MAXM17546EVKITBE# evaluation kit
- 7.5V to 42V DC, 4A power supply
- Dummy load capable of sinking 5A
- Digital voltmeter (DVM)
- 100MHz dual-trace oscilloscope

Equipment Setup and Test Procedure

The MAXM17546EVKITBE# is fully assembled and tested. Follow the steps below to verify board operation.

Caution: Do not turn on the power supply until all connections are completed.

- 1) Set the power supply at a voltage between 7.5V and 42V. Disable the power supply.
- 2) Connect the positive and negative terminals of the power supply to VIN and GND PCB pads, respectively.
- 3) Connect the positive and negative terminals of the 5A load to VOUT and GND PCB pads respectively, and the set the load to 0A.
- 4) Connect the DVM across the VOUT PCB pad and the GND PCB pad.
- 5) Verify that shunts are not installed on jumper J1 (see [Figure 1](#) for details).
- 6) Select the shunt position on jumper J2 according to the intended mode of operation (see [Table 2](#) for details).
- 7) Enable the input power supply.
- 8) Verify the DVM display 5V.
- 9) Increase the load up to 5A to verify the output voltage is 5V using DVM.

[Ordering Information](#) appears at end of data sheet.

Detailed Description of Hardware

The MAXM17546EVKITBE# is a proven circuit to demonstrate the high-voltage, high-efficiency, and compact solution size of the MAXM17546 synchronous step-down DC-DC power module. The output voltage is preset to 5V to operate from 7.5V to 42V input and provides up to 5A load current. The optimal frequency is set at 450kHz to maximize efficiency and minimize component size. The EV kit includes test points for monitoring voltage at V_{CC} , \overline{RESET} and LX pins.

Soft-Start Input (SS)

The MAXM17546 module implements adjustable soft-start operation to reduce inrush current. A capacitor connected from the SS pin to SGND programs the soft-start time. The selected output capacitance (C_{SEL}) and the output voltage (V_{OUT}) determine the minimum required soft-start capacitor as follows:

$$C_{SS} \geq 28 \times 10^{-6} \times C_{SEL} \times V_{OUT}$$

The soft-start time (t_{SS}) is related to the capacitor connected at SS (C_{SS}) by the following equation:

$$t_{SS} = \frac{C_{SS}}{5.55}$$

where t_{SS} is in ms and C_{SS} is in nF. For example, to program a 4ms soft-start time, a 22nF capacitor should be connected from the SS pin to SGND.

Regulator Enable/ Undervoltage-Lockout Level (EN/UVLO)

The EV kit offers an adjustable input undervoltage-lockout level by resistor-dividers connecting between the IN, EN/UVLO, and GND pins. For normal operation, a shunt

should not be installed across pins 1-2 on J1 to enable the output through an internal pullup 3.32M Ω resistor from the EN/UVLO pin to the IN pin. To disable the output, install the shunt across pins 1-2 on J1 to pull the EN/UVLO pin to GND. See [Table 1](#) for J1 setting details. The EV kit also provides an R3 resistor to program a UVLO threshold voltage at which an input-voltage level device turns on. The R3 resistor can be calculated by the following equation:

$$R3 = 3.32 \times 1.215 / (V_{INU} - 1.215)$$

where V_{INU} is the input voltage at which the device is required to turn on, and R3 is in M Ω .

MODE/SYNC Selection (MODE)

The device's MODE pin can be used to select among the PWM, PFM, or DCM modes of operation. The logic state of the MODE pin is latched when the V_{CC} and EN/UVLO voltages exceed the respective UVLO rising thresholds and all internal voltages are ready to allow LX switching. State changes on the MODE pin are ignored during normal operation. Refer to the MAXM17546 IC data sheet for more information on the PWM, PFM, and DCM modes of operation.

[Table 2](#) lists J2 jumper settings that can be used to configure the desired mode of operation. The internal oscillator of the device can be synchronized to an external clock signal on the SYNC pin. The external synchronization clock frequency must be between $1.1 \times f_{SW}$ and $1.4 \times f_{SW}$, where f_{SW} is the frequency of operation set by R4. The minimum external clock high pulse width should be greater than 50ns, while the minimum external clock low pulse width should be greater than 160ns.

Table 1. EN/UVLO Enable/Disable Configuration (J1)

SHUNT POSITION	EN PIN	MAXM17546_OUTPUT
1-2	Connected to GND	Disabled
Not installed*	Connected to the center node of resistor-divider 3.32M Ω and R3	Enabled, UVLO level set through the 3.32M Ω and R3 resistors

*Default position

Table 2. MODE Description (J2)

SHUNT POSITION	MODE PIN	MAXM17546_MODE
Not installed	Unconnected	PFM mode of operation
1-2	Connected to V_{CC}	DCM mode of operation
2-3*	Connected to GND	PWM mode of operation

*Default position

EXTVCC Linear Regulator

Powering V_{CC} of the IC from EXTVCC increases the efficiency of the power converter at higher input voltages. If the applied EXTVCC voltage is greater than 4.7V (typ), V_{CC} is powered from EXTVCC. If EXTVCC is lower than 4.7V (typ), V_{CC} is powered from V_{IN} . Refer to the MAXM17546 module data sheet for further information. To connect EXTVCC to V_{OUT} place the shunt across pins 2-3 of jumper J3. Refer to [Table 3](#) for summary of EXTVCC jumper configurations.

Electromagnetic Interference (EMI)

Compliance to conducted emissions (CE) standards requires an EMI filter at the input of a switching power converter. The EMI filter attenuates high-frequency currents drawn by the switching power converter, and limits the noise injected back into the input power source.

Use of EMI filter components as shown in the EV kit schematic results in lower conducted emissions below CISPR22 Class B limits. The MAXM17546EVKITBE#

PCB layout is also designed to limit radiated emissions from switching nodes of the power converter resulting in radiated emissions below CISPR22 Class B limits.

Hot-Plug-In and Long Input Cables

The MAXM17546EVKITBE# PCB provides an electrolytic capacitor (C24, 47 μ F/80V) to dampen input voltage peaks and oscillations that can arise during hot-plug-in and/or due to long input cables. This capacitor limits the peak voltage at the input of the MAXM17546 power module when the EV kit is powered directly from a precharged capacitive source or an industrial backplane PCB. Long input cables, between the input power source and the EV kit circuit can cause input-voltage oscillations due to the inductance of the cables. The equivalent series resistance (ESR) of the electrolytic capacitor helps damp out the oscillations caused by long input cables. Further, capacitors C16 (150pF/100V) and C17 (0.1 μ F/100V) placed near the input of the board helps in attenuating high frequency noise.

Table 3. EXTVCC Configuration (J3)

SHUNT POSITION	EXTVCC PIN	EXTVCC FUNCTION
Not installed	Unconnected	V_{CC} Powered by V_{IN}
1-2	Connected to GND	V_{CC} Powered by V_{IN}
2-3*	Connected to V_{OUT}	V_{CC} Powered by V_{OUT}

*Default position

MAXM17546EVKITBE# Performance Report

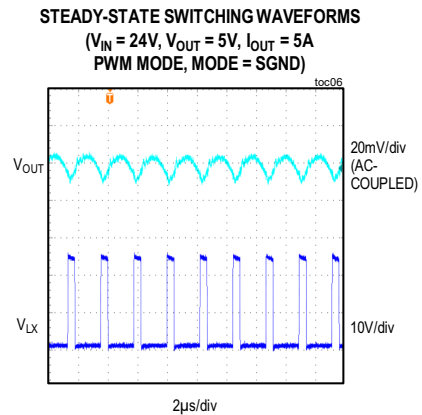
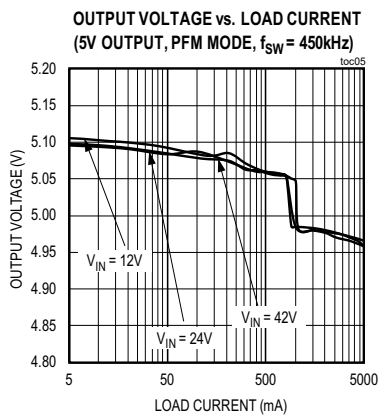
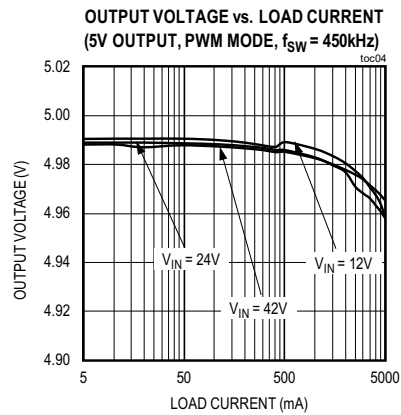
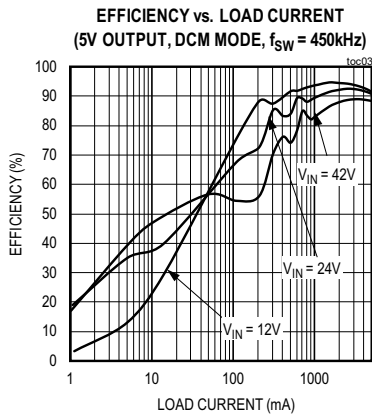
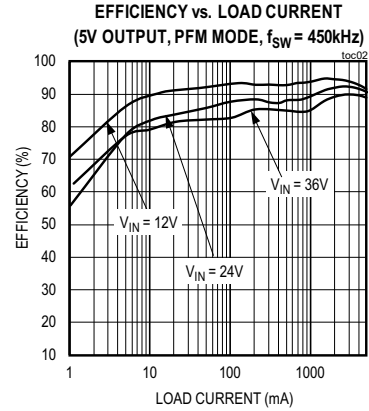
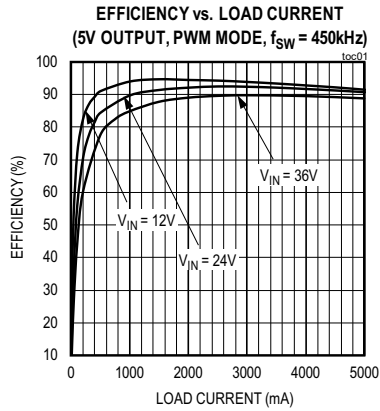

MAXM17546EVKITBE# Performance Report (continued)

POWER-UP AND DOWN THROUGH EN/UVLO
 (VIN = 24V, VOUT = 5V, IOUT = 5A
 PWM MODE, MODE = SGND)

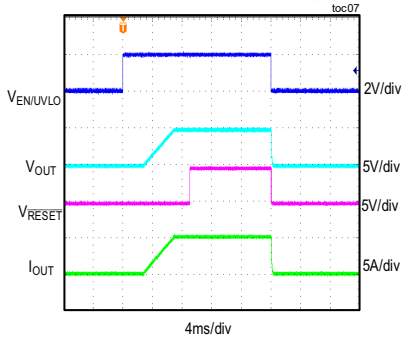

LOAD TRANSIENT
 (VIN = 24V, VOUT = 5V, IOUT = 0A TO 2.5A
 PWM MODE, MODE = SGND)

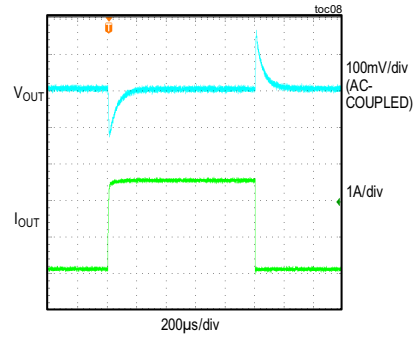

LOAD TRANSIENT
 (VIN = 24V, VOUT = 5V, IOUT = 2.5A TO 5A
 PWM MODE, MODE = SGND)

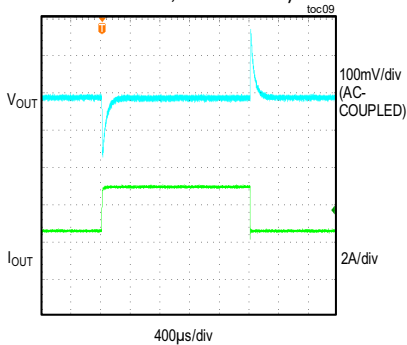

BODE PLOT
 (VIN = 24V, VOUT = 5V, IOUT = 5A)

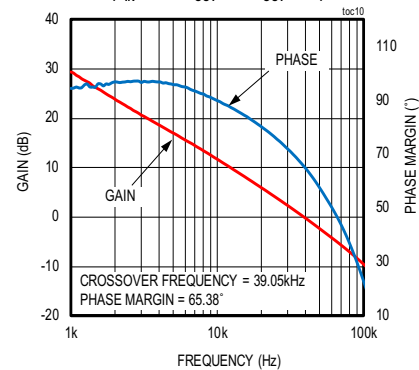

CONDUCTED EMISSION PLOT
 (WITH FILTER C18 = 4.7µF, L1 = 8.2µH,
 C19 = C20 = C21 = C22 = 4.7µF, C23 = 0.1µF, C1 = 220pF)

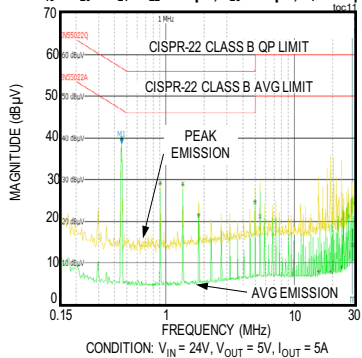

RADIATED EMISSION PLOT
 (NO FILTER C18 = OPEN, L1 = SHORT,
 C19 = C20 = C21 = C22 = C23 = C1 = OPEN)

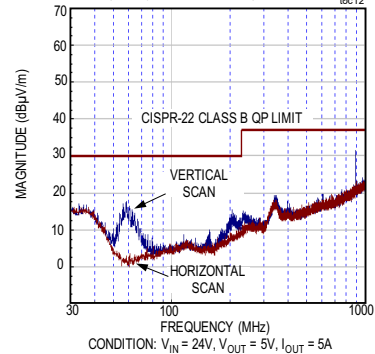

MAXM17546EVKITBE# 5V Output Evaluation Kit

Evaluates: MAXM17546 5V Output

Ordering Information

PART	TYPE
MAXM17546EVKITBE#	EV Kit

#Denotes RoHS compliant.

Component Suppliers

SUPPLIER	WEBSITE
Murata Americas	www.murata.com
Panasonic Corp.	www.panasonic.com
TDK Corp.	www.component.tdk.com
Vishay Intertechnology	www.vishay.com
Yageo	www.yageo.com
Coilcraft Inc	www.coilcraft.com

Note: Indicate that you are using the MAXM17546 when contacting these component suppliers.

MAXM17546EVKITBE# Bill of Materials

ITEM	QTY	DESIGNATION	DESCRIPTION	MANUFACTURER PART NUMBER - 1	MANUFACTURER PART NUMBER - 2
1	2	C2, C3	220pF±5%, 100V, C0G ceramic capacitor (0603)	TDK C1608C0G2A221J080AA	
2	4	C4-C7	4.7µF±10%, 50V, X7R ceramic capacitor (1206)	MURATA GRM31CR71H475KA12	MURATA GRM31CR71H475KA12
3	4	C8, C9, C15, C17	0.1µF±10%, 100V, X7R ceramic capacitor (0603)	MURATA GCJ188R72A104KA01	YAGEO CC0603KRX7R0BB104
4	1	C10	2.2pF±0.1p, 50V, X7R ceramic capacitor (0603)	AVX 06035J2R2BBT	
5	1	C11	0.022µF±10%, 50V, X7R ceramic capacitor (0603)	MURATA GCJ188R71H223KA01	KEMET C0603C223K5RAC
6	3	C12-C14	22µF±10%, 25V, X7R ceramic capacitor (1210)	MURATA GRM32ER71E226KE15	
7	1	C16	150pF±5%, 100V, C0G ceramic capacitor (0402)	TDK C1005C0G2A151J050BA	
8	1	C24	47µF±20%, 80V, Aluminium Electrolytic	PANASONIC EEE-FK1K470P	
9	1	R1	249KΩ±1% resistor (0603)	PANASONIC ERJ-3EKF2493	
10	1	R2	54.9KΩ±1% resistor (0603)	VISHAY DALE CRCW060354K9FK	
11	1	R3	665KΩ±1% resistor (0603)	VISHAY DALE CRCW0603665KFK	
12	1	R5	10KΩ±1% resistor (0603)	VISHAY DALE CRCW060310K0FK	PANASONIC ERJ-3EKF1002
13	1	R6	0Ω±1% resistor (0603)	VISHAY DALE CRCW06030000ZS	PANASONIC ERJ-3GEY0R00
14	1	U1	MAXM17546 DC-DC Module	MAXM17546ALY#	
15	1	C1	OPTIONAL : 220pF±5%, 100V, C0G ceramic capacitor (0603)	TDK C1608C0G2A221J080AA	
16	5	C18-C22	OPTIONAL : 4.7µF±10%, 50V, X7R ceramic capacitor (1206)	MURATA GRM31CR71H475KA12	MURATA GRJ31CR71H475KE11
17	1	C23	OPTIONAL : 0.1µF±10%, 100V, X7R ceramic capacitor (0603)	MURATA GCJ188R72A104KA01	YAGEO CC0603KRX7R0BB104
18	1	L1	OPTIONAL : 8.2µH±20%, Inductor	Coilcraft XAL5050-822ME	
19	1	R4	OPTIONAL : OPEN (0603)		

MAXM17546EVKITBE# 5V Output Evaluation Kit

Evaluates: MAXM17546 5V Output

MAXM17546EVKITBE# Schematic

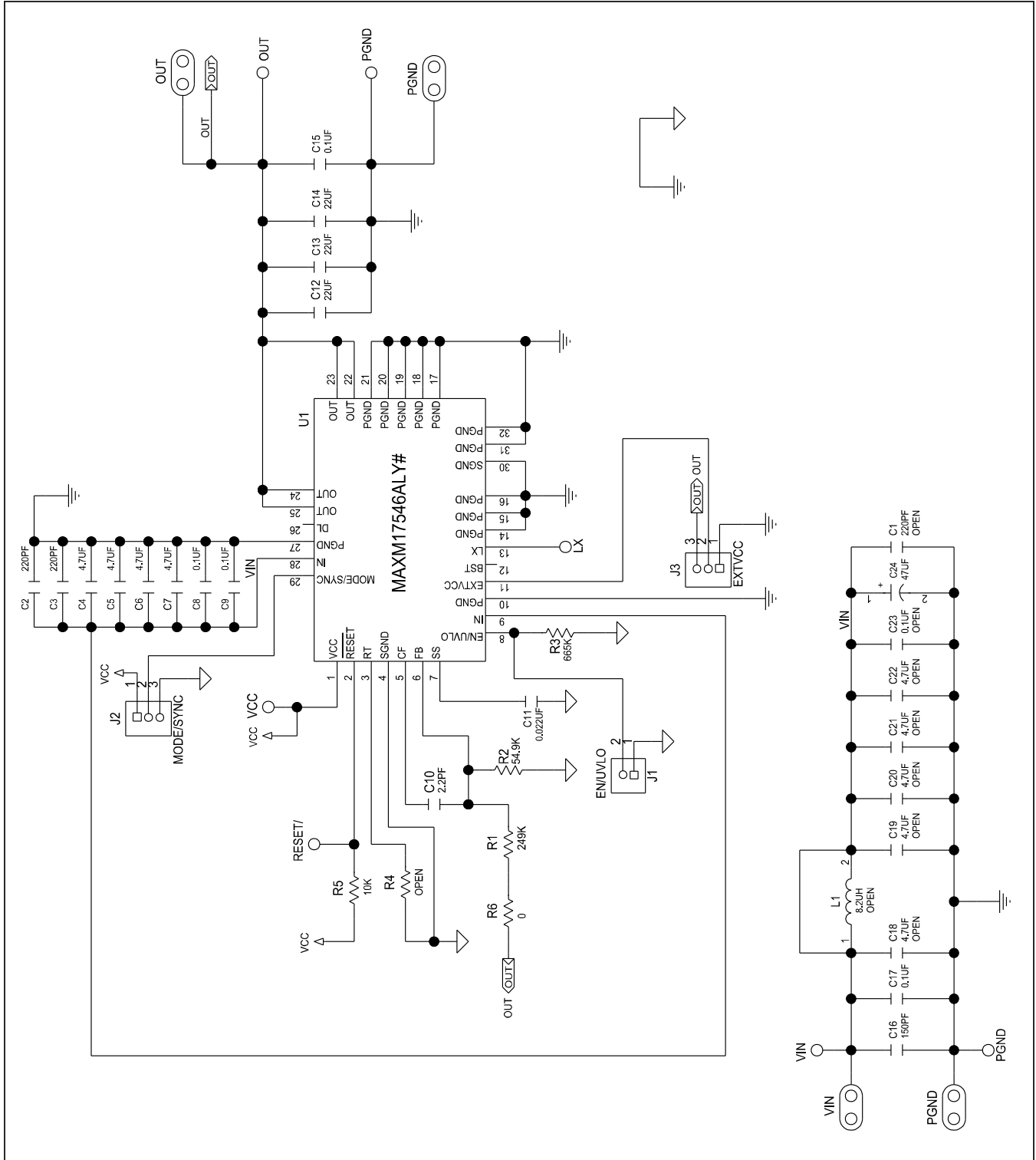

MAXM17546EVKITBE# PCB Layout

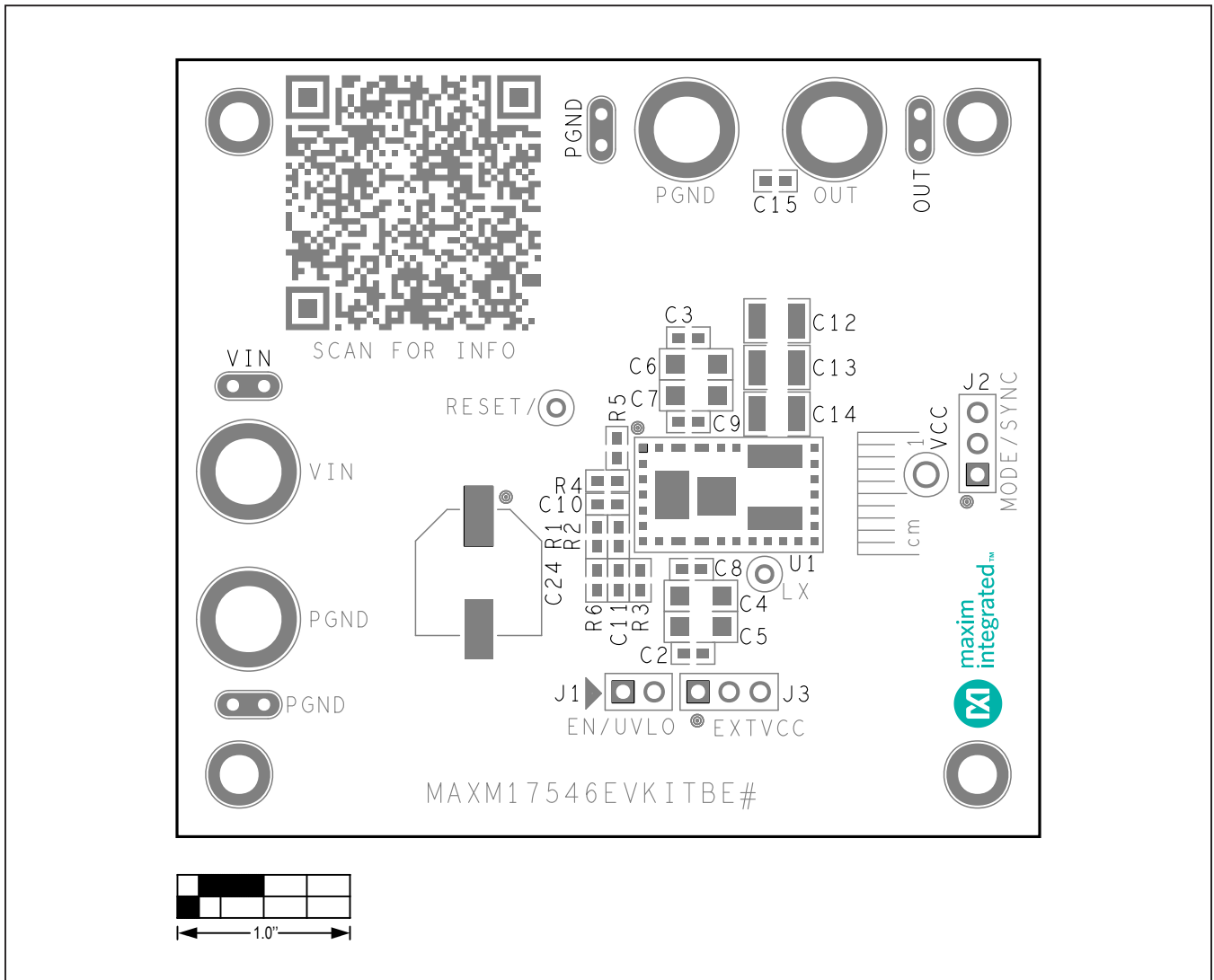

Figure 1. MAXM17546EVKITBE# 5V Output EV kit PCB Layout—Top Silkscreen

MAXM17546EVKITBE# PCB Layout (continued)

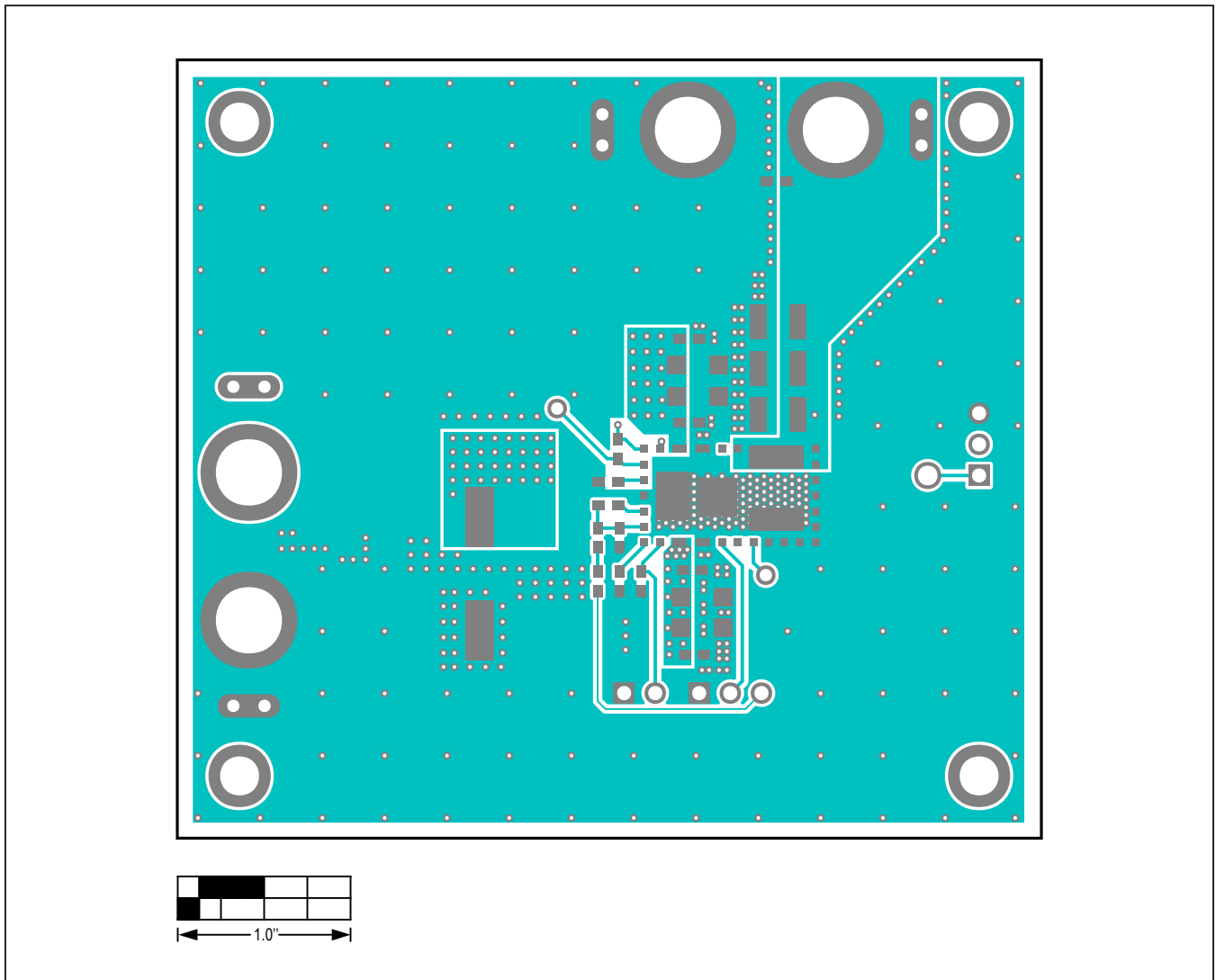

Figure 2. MAXM17546EVKITBE# 5V Output EV kit PCB Layout—Top Layer

MAXM17546EVKITBE# PCB Layout (continued)

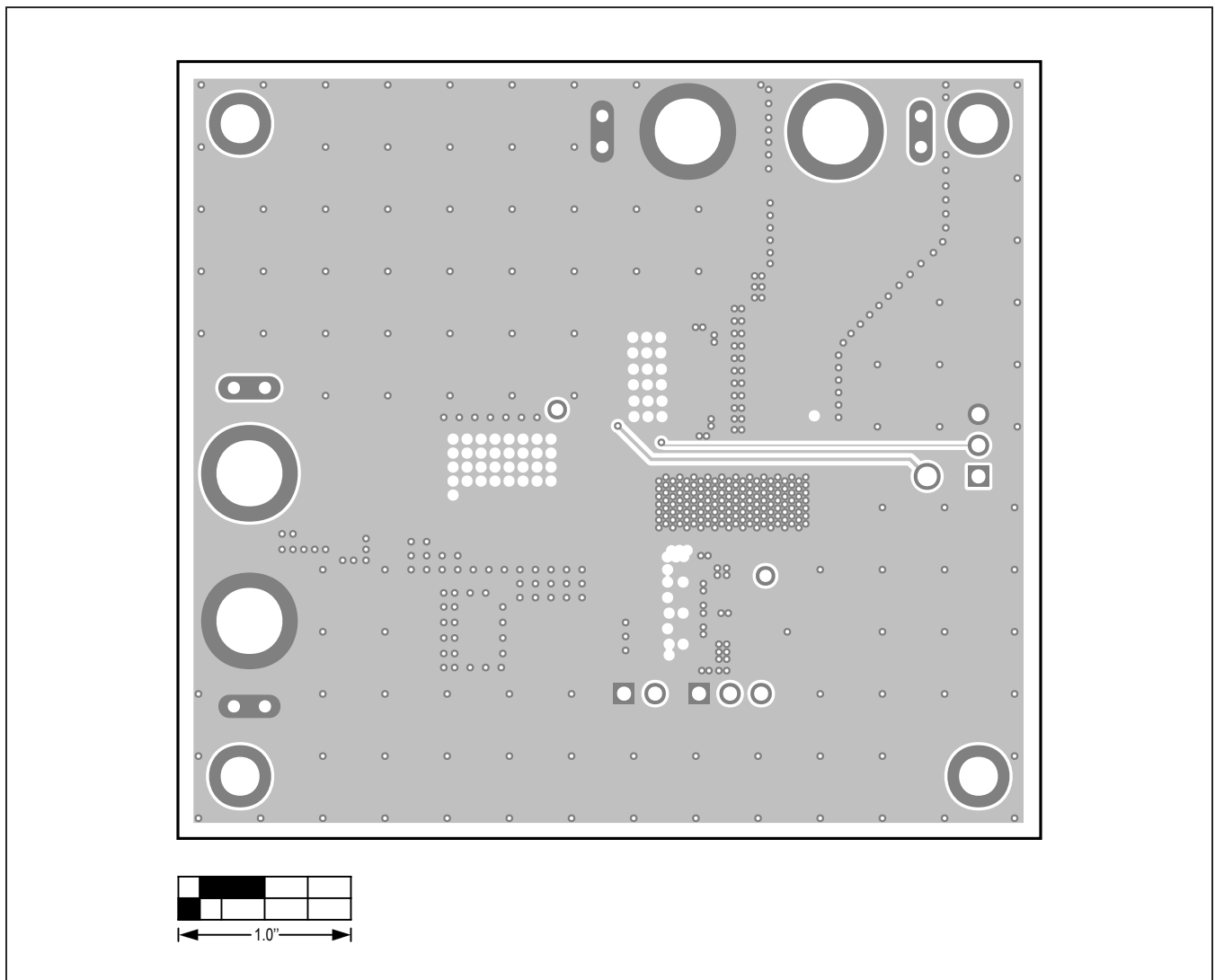

Figure 3. MAXM17546EVKITBE# 5V Output EV kit PCB Layout—Layer 2

MAXM17546EVKITBE# PCB Layout (continued)

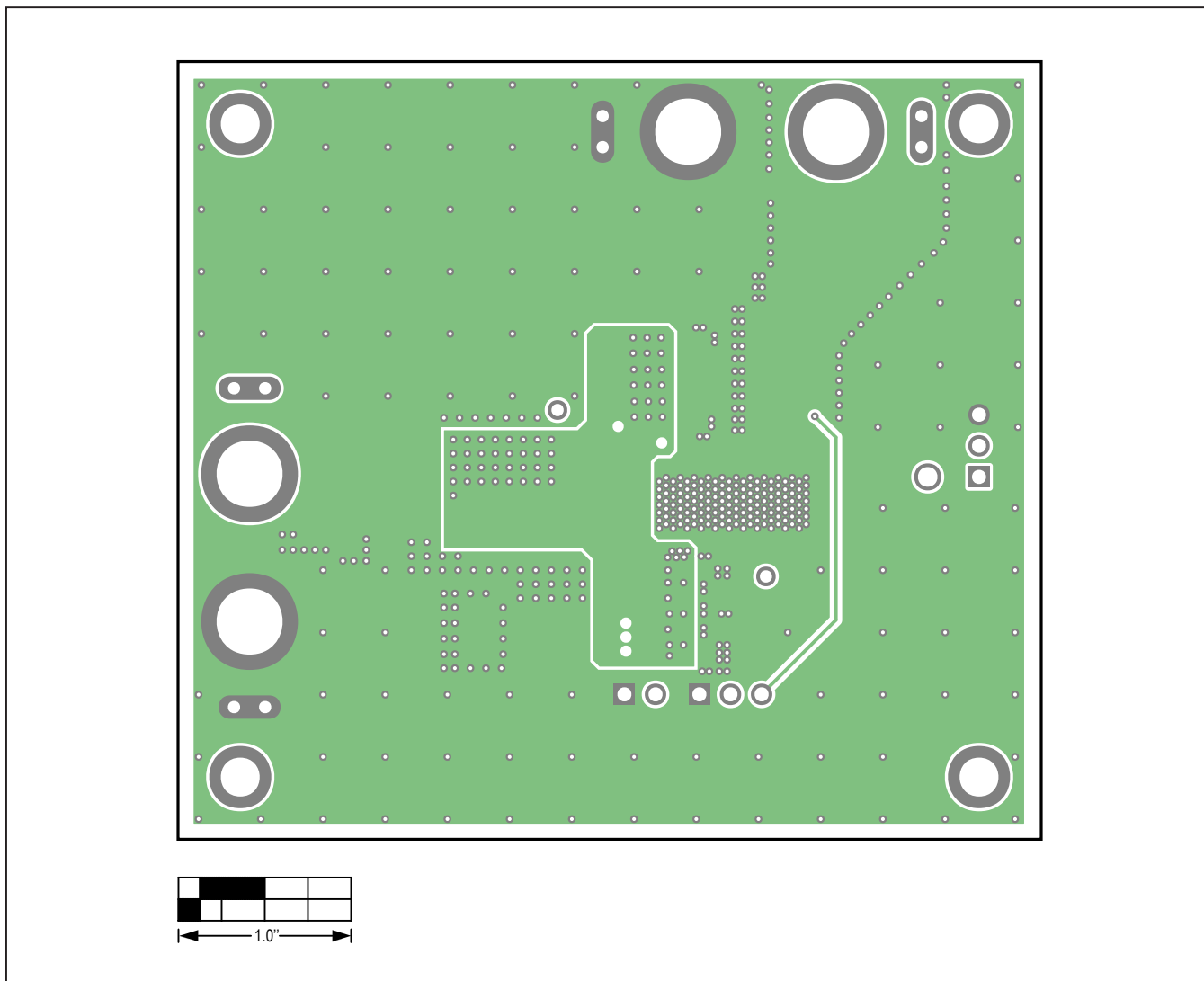

Figure 4. MAXM17546EVKITBE# 5V Output EV kit PCB Layout—Layer 3

MAXM17546EVKITBE# PCB Layout (continued)

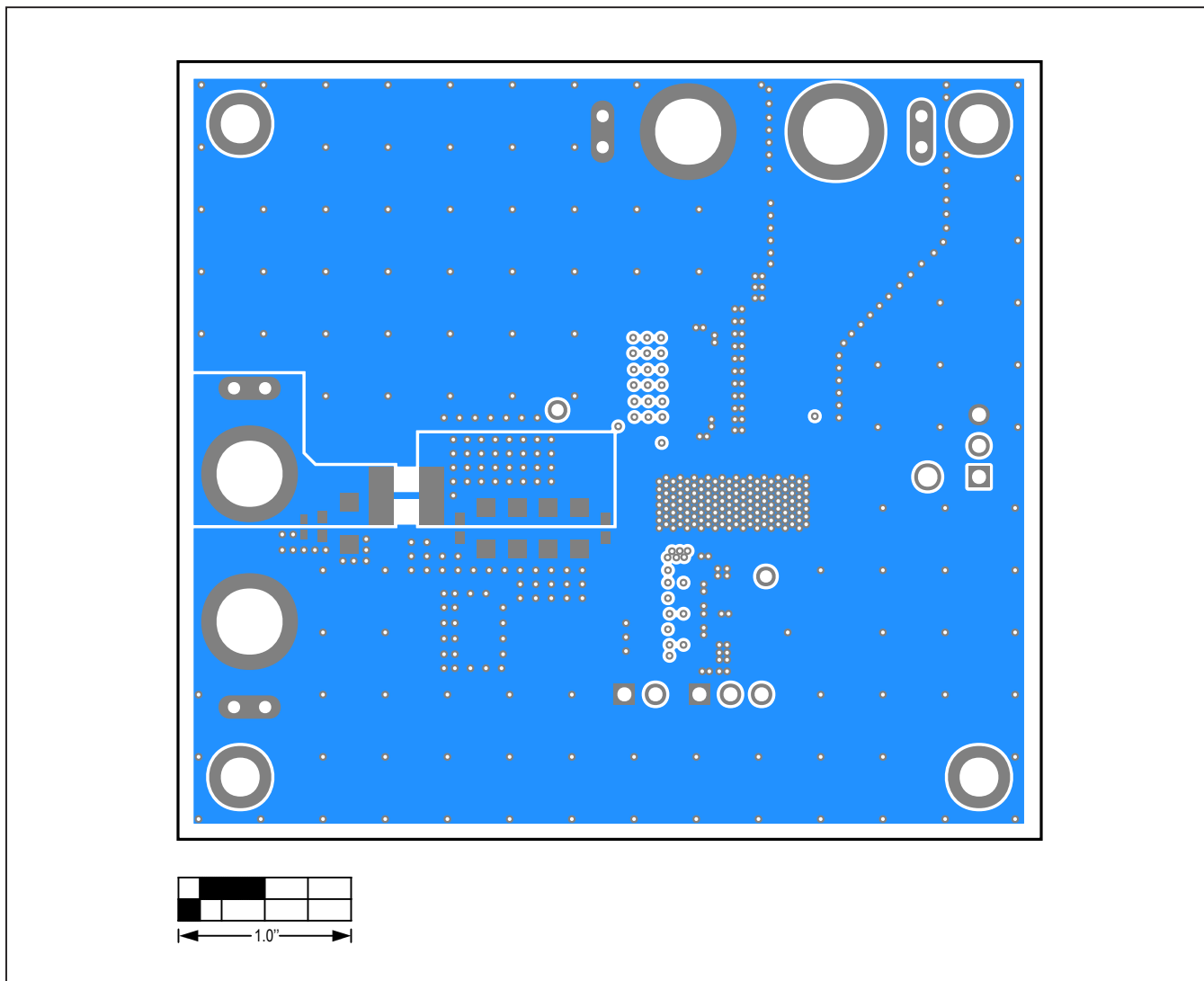

Figure 5. MAXM17546EVKITBE# 5V Output EV kit PCB Layout—Bottom Layer

MAXM17546EVKITBE# PCB Layout (continued)

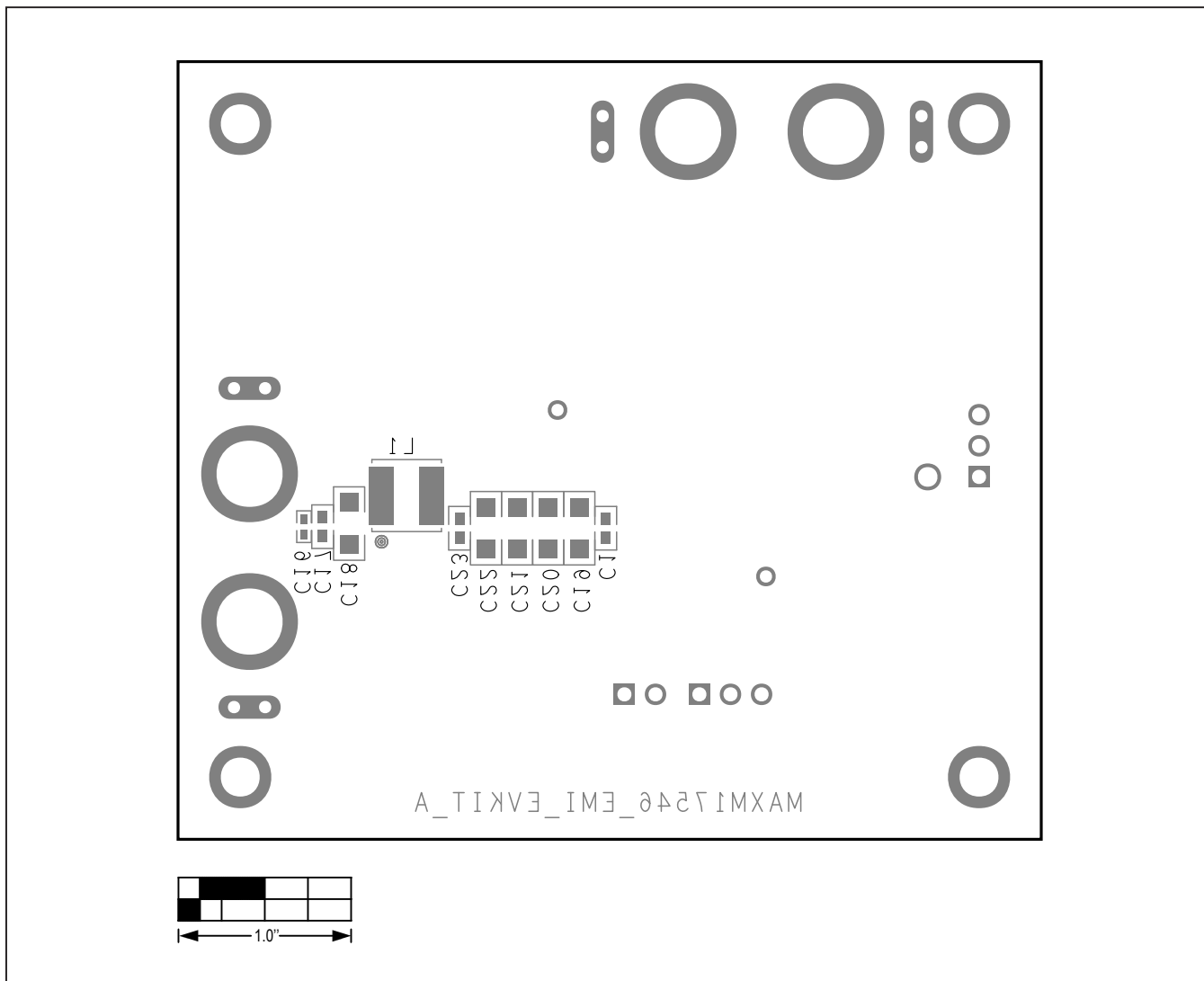

Figure 6. MAXM17546EVKITBE# 5V Output EV kit PCB Layout—Bottom Silkscreen

Revision History

REVISION NUMBER	REVISION DATE	DESCRIPTION	PAGES CHANGED
0	10/19	Initial release	—

For pricing, delivery, and ordering information, please visit Maxim Integrated's online storefront at <https://www.maximintegrated.com/en/storefront/storefront.html>.

Maxim Integrated cannot assume responsibility for use of any circuitry other than circuitry entirely embodied in a Maxim Integrated product. No circuit patent licenses are implied. Maxim Integrated reserves the right to change the circuitry and specifications without notice at any time.