



PESD3V3L1ULS

Unidirectional ESD protection diode

27 April 2021

Product data sheet

1. General description

Unidirectional ElectroStatic Discharge (ESD) protection diode designed to protect one signal line from the damage caused by ESD and other transients. The device is housed in a leadless ultra small DFN1006BD-2 (SOD882BD) Surface-Mounted Device (SMD) plastic package with side-wettable flanks (SWF).

2. Features and benefits

- Ultra small SMD plastic package
- ESD protection of one line
- Side-wettable flanks
- Low clamping voltage: $V_{CL} = 20\text{ V}$
- Ultra low leakage current: $I_{RM} < 400\text{ nA}$
- ESD protection up to 30 kV
- IEC 61000-4-2 (ESD): level 4
- IEC 61000-4-5 (surge): I_{PPM} up to 14 A

3. Applications

- Computers and peripherals
- Audio and video equipment
- Parallel ports
- Communication systems



4. Quick reference data

Table 1. Quick reference data

Symbol	Parameter	Conditions	Min	Typ	Max	Unit
V_{RWM}	reverse standoff voltage	$T_{amb} = 25\text{ °C}$	-	-	3.3	V
C_d	diode capacitance	$f = 1\text{ MHz}; V_R = 0\text{ V}; T_{amb} = 25\text{ °C}$	-	105	160	pF

5. Pinning information

Table 2. Pinning information

Pin	Symbol	Description	Simplified outline	Graphic symbol
1	K	cathode ^[1]	 <p>Transparent top view</p> <p>DFN1006BD-2 (SOD882BD)</p>	 <p>1 2</p> <p><i>sym035</i></p>
2	A	anode		

[1] The marking bar indicates the cathode.

6. Ordering information

Table 3. Ordering information

Type number	Package		
	Name	Description	Version
PESD3V3L1ULS	DFN1006BD-2	Leadless ultra small plastic package with side-wettable flanks (SWF); 2 terminals; 0.65 mm pitch; 1 mm x 0.6 mm x 0.47 mm body	SOD882BD

7. Marking

Table 4. Marking codes

Type number	Marking code
PESD3V3L1ULS	8N

8. Limiting values

Table 5. Limiting values

In accordance with the Absolute Maximum Rating System (IEC 60134).

Symbol	Parameter	Conditions		Min	Max	Unit
I_{PPM}	rated peak pulse current	$t_p = 8/20 \mu s$	[1]	-	14	A
T_j	junction temperature			-	150	°C
T_{amb}	ambient temperature			-55	150	°C
T_{stg}	storage temperature			-65	150	°C
ESD maximum ratings						
V_{ESD}	electrostatic discharge voltage	IEC 61000-4-2 (contact discharge)	[2]	-	30	kV

- [1] Non-repetitive current pulse 8/20 μs exponential decay waveform according to IEC61000-4-5.
- [2] Device stressed with ten non-repetitive ESD pulses.

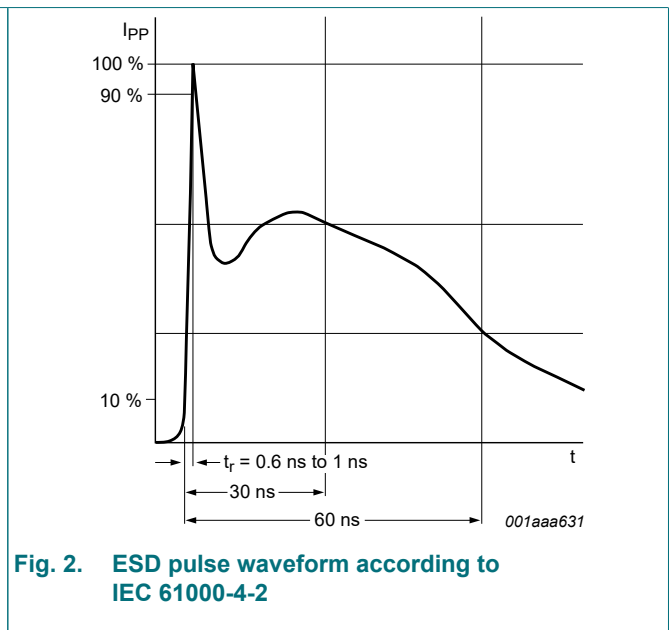
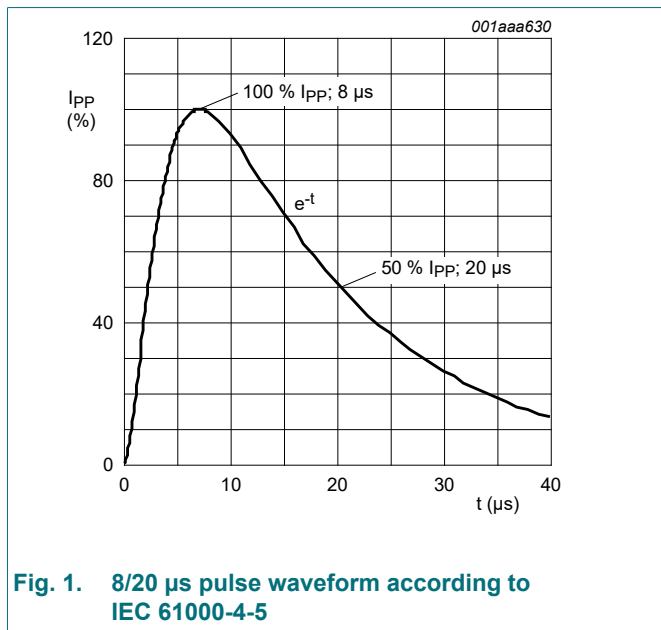

9. Characteristics

Table 6. Characteristics

Symbol	Parameter	Conditions	Min	Typ	Max	Unit	
V_{RWM}	reverse standoff voltage	$T_{amb} = 25\text{ °C}$	-	-	3.3	V	
V_{BR}	breakdown voltage	$I_R = 5\text{ mA}; T_{amb} = 25\text{ °C}$	[1]	5.2	5.6	6	V
I_{RM}	reverse leakage current	$V_{RWM} = 3.3\text{ V}; T_{amb} = 25\text{ °C}$	-	0.4	2	μA	
C_d	diode capacitance	$f = 1\text{ MHz}; V_R = 0\text{ V}; T_{amb} = 25\text{ °C}$	-	105	160	pF	
V_{CL}	clamping voltage	$I_{PP} = 1\text{ A}; T_{amb} = 25\text{ °C}$	[2]	-	-	7.5	V
		$I_{PPM} = 14\text{ A}; T_{amb} = 25\text{ °C}$	[2]	-	-	17.5	V
R_{dyn}	dynamic resistance	$I_R = 10\text{ A}; T_{amb} = 25\text{ °C}$	[3]	-	0.46	Ω	

[1] Pulse test: $t_p \leq 300\text{ }\mu\text{s}$; duty cycle ≤ 0.02 .

[2] Non-repetitive current pulse 8/20 μs exponential decay waveform according to IEC61000-4-5.

[3] Non-repetitive current pulse, Transmission Line Pulse (TLP) $t_p = 100\text{ ns}$; square pulse; ANSI / ESD STM5.5.1-2008.

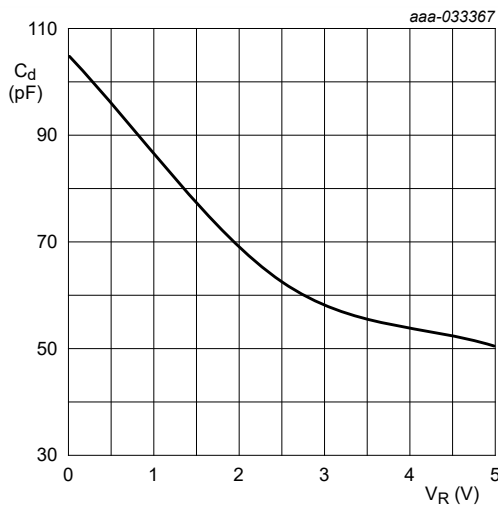

$f = 1\text{ MHz}; T_{amb} = 25\text{ °C}$

Fig. 3. Diode capacitance as a function of reverse voltage; typical values

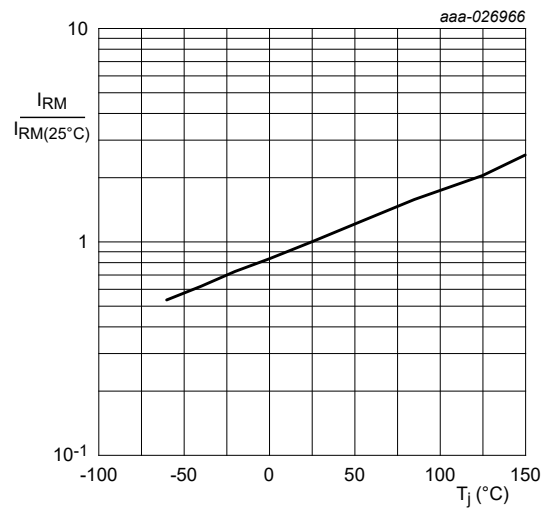
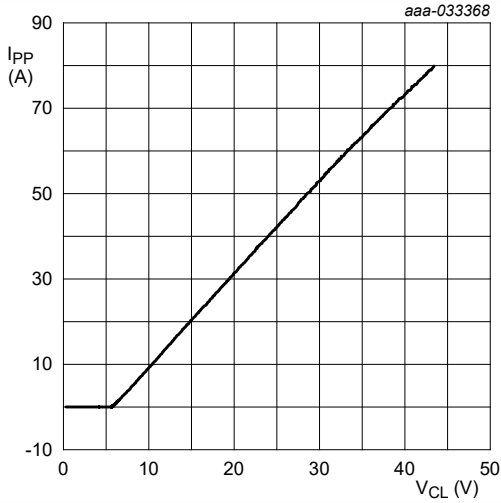
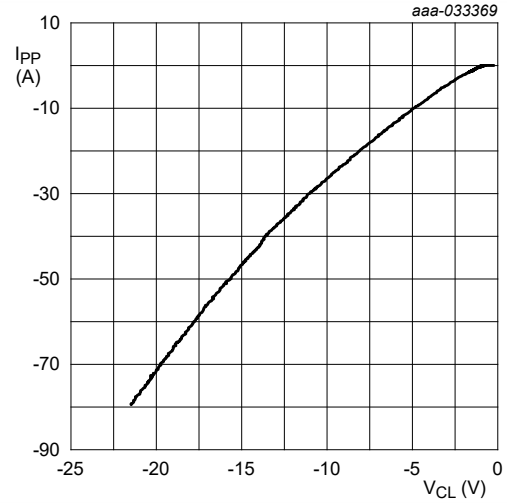

Fig. 4. Relative variation of reverse leakage current as a function of junction temperature; typical values



Transmission Line Pulse (TLP);
 $t_p = 100 \text{ ns}$; $t_r = 1 \text{ ns}$

Fig. 5. Dynamic resistance with positive clamping; typical values



Transmission Line Pulse (TLP);
 $t_p = 100 \text{ ns}$; $t_r = 1 \text{ ns}$

Fig. 6. Dynamic resistance with negative clamping; typical values

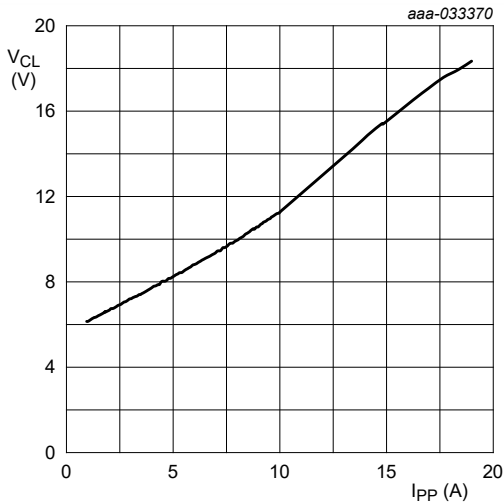

IEC 61000-4-5; $t_p = 8/20 \text{ }\mu\text{s}$; positive pulse

Fig. 7. Dynamic resistance with positive clamping; typical values

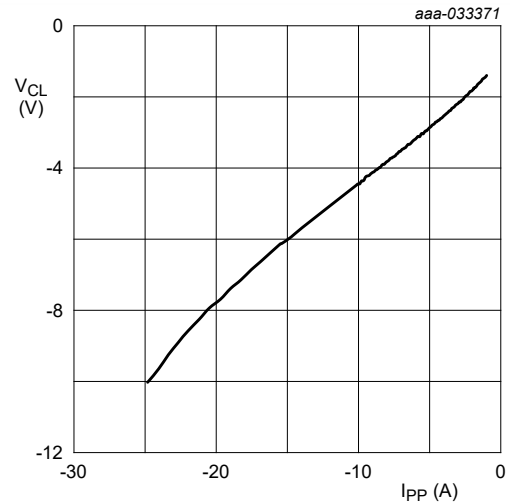

IEC 61000-4-5; $t_p = 8/20 \text{ }\mu\text{s}$; negative pulse

Fig. 8. Dynamic resistance with negative clamping; typical values

10. Application information

The device is designed for the protection of one unidirectional data line from surge pulses and ESD damage. The device is suitable on lines where the signal polarities are either positive or negative with respect to ground.

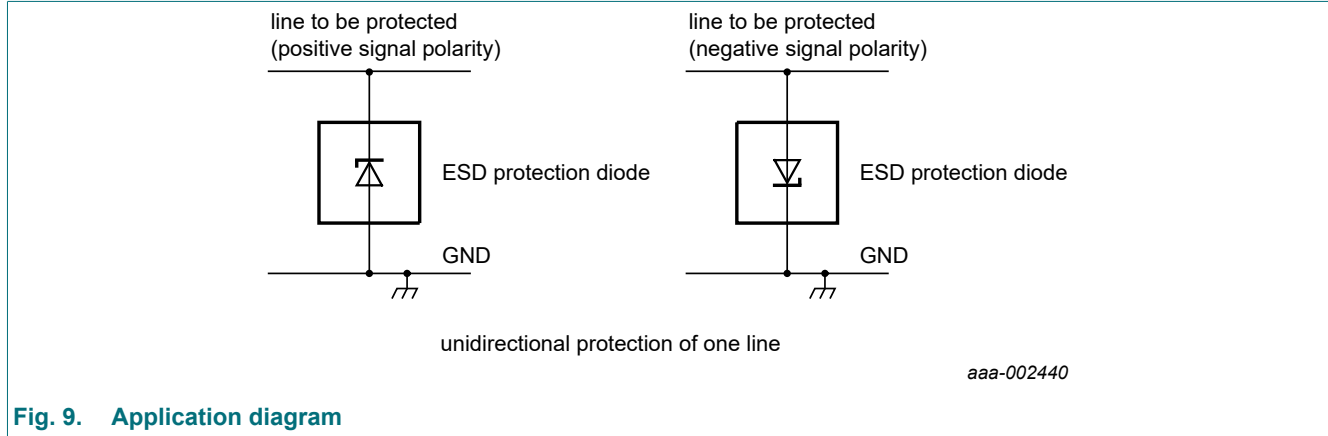

Fig. 9. Application diagram

Circuit board layout and protection device placement

Circuit board layout is critical for the suppression of ESD, Electrical Fast Transient (EFT) and surge transients. The following guidelines are recommended:

1. Place the device as close to the input terminal or connector as possible.
2. Minimize the path length between the device and the protected line.
3. Keep parallel signal paths to a minimum.
4. Avoid running protected conductors in parallel with unprotected conductors.
5. Minimize all Printed-Circuit Board (PCB) conductive loops including power and ground loops.
6. Minimize the length of the transient return path to ground.
7. Avoid using shared transient return paths to a common ground point.
8. Use ground planes whenever possible. For multilayer PCBs, use ground vias.

11. Package outline

DFN1006BD-2 Leadless ultra small plastic package with side-wettable flanks (SWF); 2 terminals; 0.65 mm pitch; 1 mm x 0.6 mm x 0.47 mm body

SOD882BD

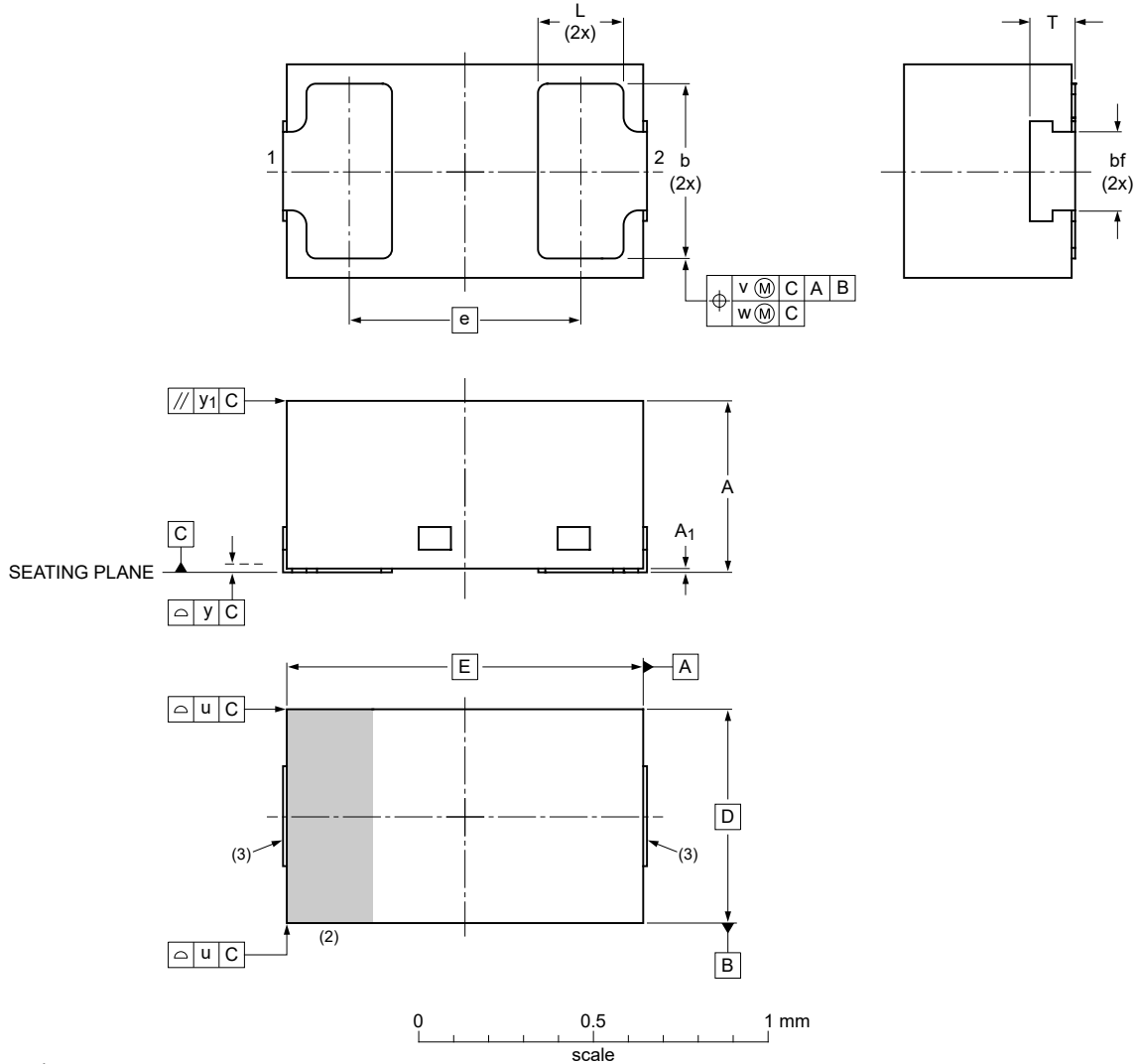

Dimensions

Unit	A ⁽¹⁾	A ₁	bf ⁽¹⁾	b	D	E	e	L	T ⁽¹⁾	u	v	w	y	y ₁
max	0.50	0.04		0.55				0.30	0.22					
mm nom	0.47			0.50	0.60	1.00	0.65	0.25	0.16	0.05	0.10	0.05	0.05	0.05
min	0.44		0.20	0.45				0.22	0.10					

Note

1. Dimension including plating thickness.
2. The marking bar indicates the cathode.
3. Solderable lead end, protrusion max. 0.02 mm.

sod882bd_po

Outline version	References				European projection	Issue date
	IEC	JEDEC	JEITA			
SOD882BD		MO-343AA				20-06-22 20-06-23

Fig. 10. Package outline DFN1006BD-2 (SOD882BD)

12. Soldering

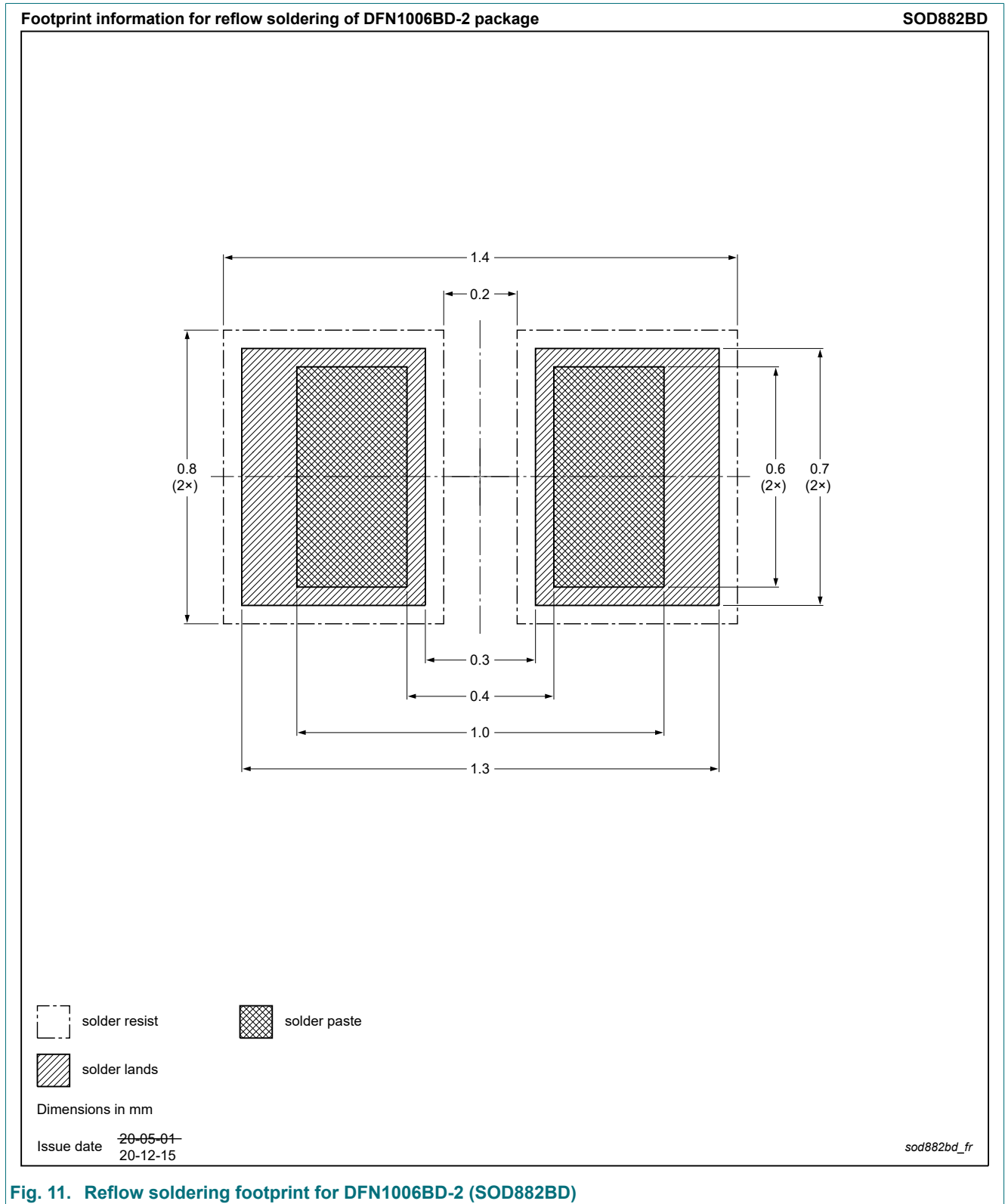

Fig. 11. Reflow soldering footprint for DFN1006BD-2 (SOD882BD)

13. Revision history

Table 7. Revision history

Data sheet ID	Release date	Data sheet status	Change notice	Supersedes
PESD3V3L1ULS v.1	20210427	Product data sheet	-	-

14. Legal information

Data sheet status

Document status [1][2]	Product status [3]	Definition
Objective [short] data sheet	Development	This document contains data from the objective specification for product development.
Preliminary [short] data sheet	Qualification	This document contains data from the preliminary specification.
Product [short] data sheet	Production	This document contains the product specification.

- [1] Please consult the most recently issued document before initiating or completing a design.
- [2] The term 'short data sheet' is explained in section "Definitions".
- [3] The product status of device(s) described in this document may have changed since this document was published and may differ in case of multiple devices. The latest product status information is available on the internet at <https://www.nexperia.com>.

Definitions

Draft — The document is a draft version only. The content is still under internal review and subject to formal approval, which may result in modifications or additions. Nexperia does not give any representations or warranties as to the accuracy or completeness of information included herein and shall have no liability for the consequences of use of such information.

Short data sheet — A short data sheet is an extract from a full data sheet with the same product type number(s) and title. A short data sheet is intended for quick reference only and should not be relied upon to contain detailed and full information. For detailed and full information see the relevant full data sheet, which is available on request via the local Nexperia sales office. In case of any inconsistency or conflict with the short data sheet, the full data sheet shall prevail.

Product specification — The information and data provided in a Product data sheet shall define the specification of the product as agreed between Nexperia and its customer, unless Nexperia and customer have explicitly agreed otherwise in writing. In no event however, shall an agreement be valid in which the Nexperia product is deemed to offer functions and qualities beyond those described in the Product data sheet.

Disclaimers

Limited warranty and liability — Information in this document is believed to be accurate and reliable. However, Nexperia does not give any representations or warranties, expressed or implied, as to the accuracy or completeness of such information and shall have no liability for the consequences of use of such information. Nexperia takes no responsibility for the content in this document if provided by an information source outside of Nexperia.

In no event shall Nexperia be liable for any indirect, incidental, punitive, special or consequential damages (including - without limitation - lost profits, lost savings, business interruption, costs related to the removal or replacement of any products or rework charges) whether or not such damages are based on tort (including negligence), warranty, breach of contract or any other legal theory.

Notwithstanding any damages that customer might incur for any reason whatsoever, Nexperia's aggregate and cumulative liability towards customer for the products described herein shall be limited in accordance with the Terms and conditions of commercial sale of Nexperia.

Right to make changes — Nexperia reserves the right to make changes to information published in this document, including without limitation specifications and product descriptions, at any time and without notice. This document supersedes and replaces all information supplied prior to the publication hereof.

Suitability for use — Nexperia products are not designed, authorized or warranted to be suitable for use in life support, life-critical or safety-critical systems or equipment, nor in applications where failure or malfunction of an Nexperia product can reasonably be expected to result in personal

injury, death or severe property or environmental damage. Nexperia and its suppliers accept no liability for inclusion and/or use of Nexperia products in such equipment or applications and therefore such inclusion and/or use is at the customer's own risk.

Quick reference data — The Quick reference data is an extract of the product data given in the Limiting values and Characteristics sections of this document, and as such is not complete, exhaustive or legally binding.

Applications — Applications that are described herein for any of these products are for illustrative purposes only. Nexperia makes no representation or warranty that such applications will be suitable for the specified use without further testing or modification.

Customers are responsible for the design and operation of their applications and products using Nexperia products, and Nexperia accepts no liability for any assistance with applications or customer product design. It is customer's sole responsibility to determine whether the Nexperia product is suitable and fit for the customer's applications and products planned, as well as for the planned application and use of customer's third party customer(s). Customers should provide appropriate design and operating safeguards to minimize the risks associated with their applications and products.

Nexperia does not accept any liability related to any default, damage, costs or problem which is based on any weakness or default in the customer's applications or products, or the application or use by customer's third party customer(s). Customer is responsible for doing all necessary testing for the customer's applications and products using Nexperia products in order to avoid a default of the applications and the products or of the application or use by customer's third party customer(s). Nexperia does not accept any liability in this respect.

Limiting values — Stress above one or more limiting values (as defined in the Absolute Maximum Ratings System of IEC 60134) will cause permanent damage to the device. Limiting values are stress ratings only and (proper) operation of the device at these or any other conditions above those given in the Recommended operating conditions section (if present) or the Characteristics sections of this document is not warranted. Constant or repeated exposure to limiting values will permanently and irreversibly affect the quality and reliability of the device.

Terms and conditions of commercial sale — Nexperia products are sold subject to the general terms and conditions of commercial sale, as published at <http://www.nexperia.com/profile/terms>, unless otherwise agreed in a valid written individual agreement. In case an individual agreement is concluded only the terms and conditions of the respective agreement shall apply. Nexperia hereby expressly objects to applying the customer's general terms and conditions with regard to the purchase of Nexperia products by customer.

No offer to sell or license — Nothing in this document may be interpreted or construed as an offer to sell products that is open for acceptance or the grant, conveyance or implication of any license under any copyrights, patents or other industrial or intellectual property rights.

Export control — This document as well as the item(s) described herein may be subject to export control regulations. Export might require a prior authorization from competent authorities.

Non-automotive qualified products — Unless this data sheet expressly states that this specific Nexperia product is automotive qualified, the product is not suitable for automotive use. It is neither qualified nor tested in accordance with automotive testing or application requirements. Nexperia accepts no liability for inclusion and/or use of non-automotive qualified products in automotive equipment or applications.

In the event that customer uses the product for design-in and use in automotive applications to automotive specifications and standards, customer (a) shall use the product without Nexperia's warranty of the product for such automotive applications, use and specifications, and (b) whenever customer uses the product for automotive applications beyond Nexperia's specifications such use shall be solely at customer's own risk, and (c) customer fully indemnifies Nexperia for any liability, damages or failed product claims resulting from customer design and use of the product for automotive applications beyond Nexperia's standard warranty and Nexperia's product specifications.

Translations — A non-English (translated) version of a document is for reference only. The English version shall prevail in case of any discrepancy between the translated and English versions.

Trademarks

Notice: All referenced brands, product names, service names and trademarks are the property of their respective owners.

Contents

1. General description.....	1
2. Features and benefits.....	1
3. Applications.....	1
4. Quick reference data.....	1
5. Pinning information.....	2
6. Ordering information.....	2
7. Marking.....	2
8. Limiting values.....	3
9. Characteristics.....	4
10. Application information.....	6
11. Package outline.....	7
12. Soldering.....	8
13. Revision history.....	9
14. Legal information.....	10

© Nexperia B.V. 2021. All rights reserved

For more information, please visit: <http://www.nexperia.com>

For sales office addresses, please send an email to: salesaddresses@nexperia.com

Date of release: 27 April 2021
