



ARCHIVED BY FREESCALE SEMICONDUCTOR, INC. 2005

# 2.5 GHz Low Power Prescaler With Stand-By Mode

The MC12095 is a single modulus prescaler for low power frequency division of a 2.5 GHz high frequency input signal. Motorola's advanced MOSAIC™ V technology is utilized to achieve low power dissipation of 24 mW at a minimum supply voltage of 2.7 V.

On-chip output termination provides output current to drive a 2.0 pF (typical) high impedance load. If additional drive is required for the prescaler output, an external resistor can be added in parallel from the OUT pin to GND to increase the output power. Care must be taken not to exceed the maximum allowable current through the output.

Divide ratio control input (SW) selects the required divide ratio of ÷2 or ÷4. Stand-By mode is available to reduce current drain to 100µA typical when the standby pin SB is switched LOW disabling the prescaler.

- 2.5 GHz Toggle Frequency
- Supply Voltage 2.7 V to 5.5 Vdc
- Low Power 8.7 mA Typical
- Operating Temperature -40 to 85°C
- Divide by 2 or 4 Selected by the SW Pin

**NOTE:** For applications up to 1.1 GHz, please consult the MC12093 datasheet.

MOSAIC V is a trademark of Motorola

## FUNCTIONAL TABLE

SW	Divide Ratio
H	2
L	4

**NOTES:** 1. SW: H = (V<sub>CC</sub> - 0.4 V) to V<sub>CC</sub>; L = OPEN  
2. SB: H = 2.0 V to V<sub>CC</sub>; L = GND to 0.8 V

## AC Test Circuit

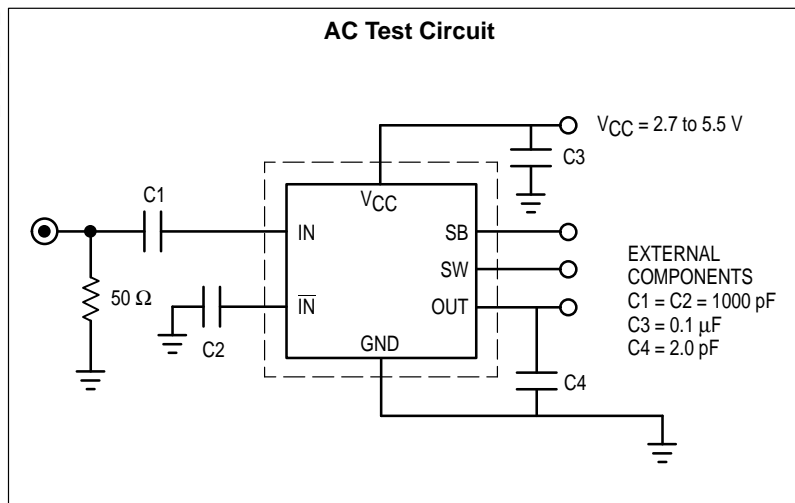

# MC12095

## MECL PLL COMPONENTS ÷2, ÷4 LOW POWER PRESCALER WITH STAND-BY MODE

SEMICONDUCTOR  
TECHNICAL DATA



**D SUFFIX**  
PLASTIC PACKAGE  
CASE 751  
(SO-8)

## PIN CONNECTIONS

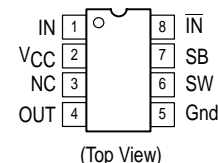

## ORDERING INFORMATION

Device	Operating Temp Range	Package
MC12095D	T <sub>A</sub> = -40 to 85°C	SO-8

**MAXIMUM RATINGS**

Parameter	Symbol	Value	Unit
Power Supply Voltage, Pin 2	$V_{CC}$	-0.5 to 6.0	Vdc
Operating Temperature Range	$T_A$	-40 to 85	°C
Storage Temperature Range	$T_{stg}$	-65 to 150	°C
Maximum Output Current, Pin 4	$I_O$	8.0	mA

**NOTE:** ESD data available upon request.

**ELECTRICAL CHARACTERISTICS** ( $V_{CC} = 2.7$  to  $5.5$  V;  $T_A = -40$  to  $85^\circ\text{C}$ , unless otherwise noted.)

Parameter	Symbol	Min	Typ	Max	Unit	
Toggle Frequency (Sine Wave)	$f_t$	500	3.0	2.5	GHz	
Supply Current	$I_{CC}$	-	8.7	14	mA	
Stand-By Current	ISB	-	100	200	$\mu\text{A}$	
Stand-By Input HIGH (SB)	$V_{IH1}$	2.0	-	$V_{CC} + 0.5$ V	V	
Stand-By Input LOW (SB)	$V_{IL1}$	GND	-	0.8	V	
Divide Ratio Control Input HIGH (SW)	$V_{IH2}$	$V_{CC} - 0.4$	$V_{CC}$	$V_{CC} + 0.5$ V	V	
Divide Ratio Control Input LOW (SW)	$V_{IL2}$	OPEN	OPEN	OPEN		
Output Voltage Swing (2pF Load)	$V_{OUT}$	500–1000 MHz Input	800	-	-	mVpp
		1000–1500 MHz Input	400	450	-	
		1500–2500 MHz Input	200	250	-	
Input Voltage Sensitivity	$V_{IN}$	200	-	1000	mVpp	

**Figure 1. Typical Minimum Input Sensitivity versus Input Frequency**

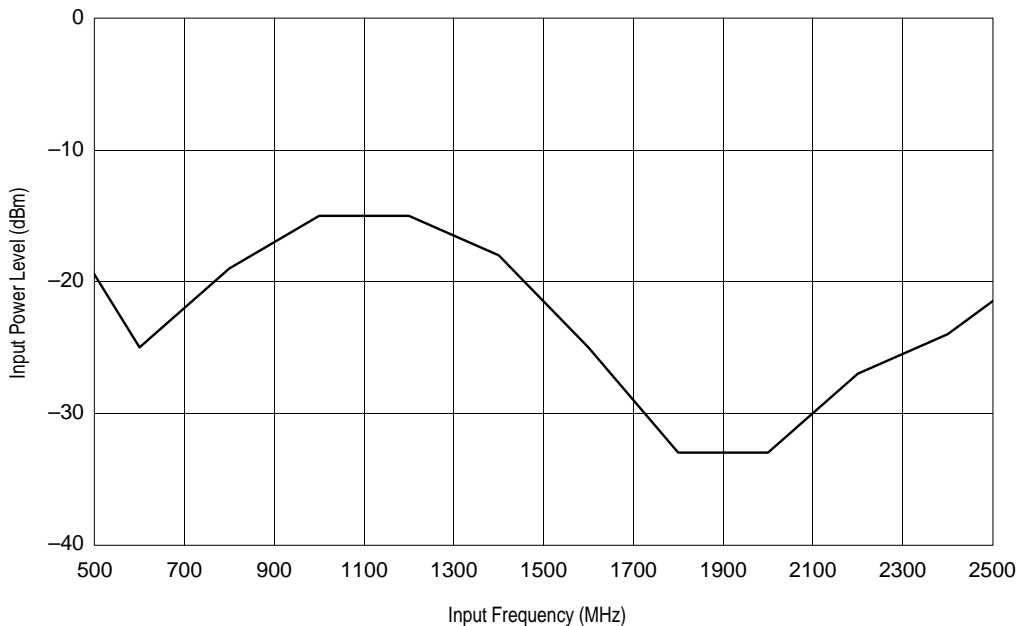

(Divide By 2 Mode,  $T = 25^\circ\text{C}$ ,  $V_{CC} = 2.7$  V)



Figure 2. Typical Output Amplitude versus Frequency over Temperature

ARCHIVED BY FREESCALE SEMICONDUCTOR, INC. 2005

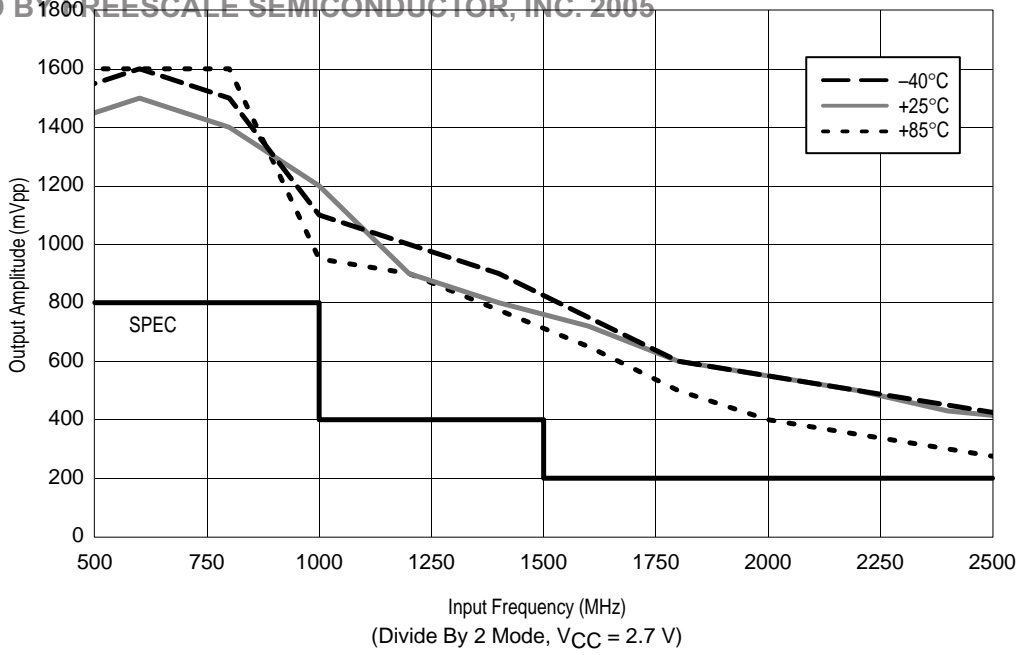
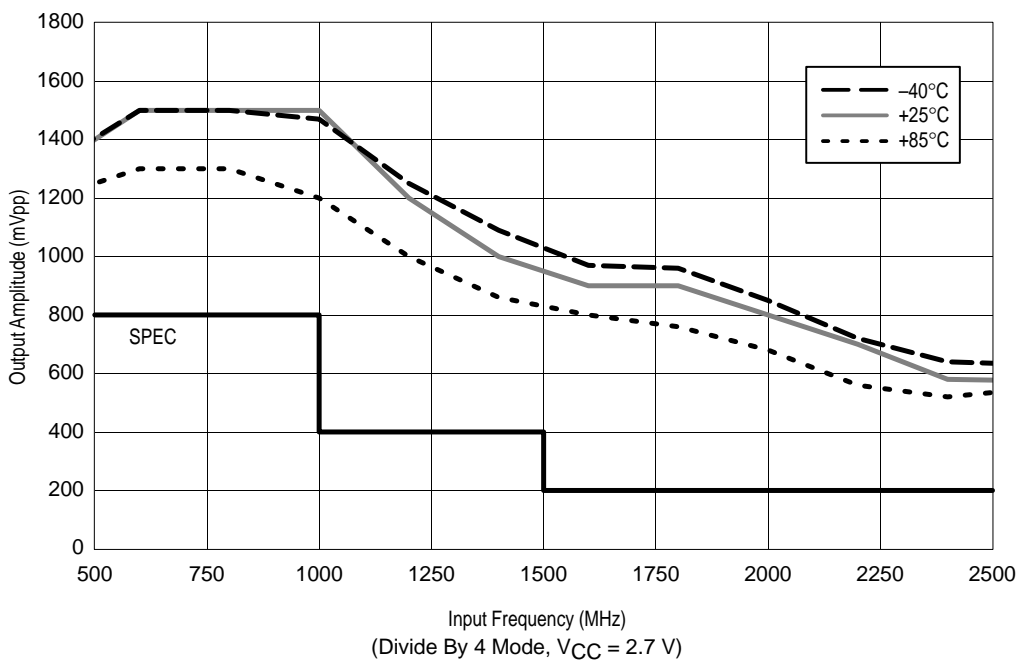

Figure 3. Typical Output Amplitude versus Frequency over Temperature



Freescale Semiconductor, Inc. ARCHIVED BY FREESCALE SEMICONDUCTOR, INC. 2005

ARCHIVE INFORMATION



Figure 4. Input Impedance versus Frequency

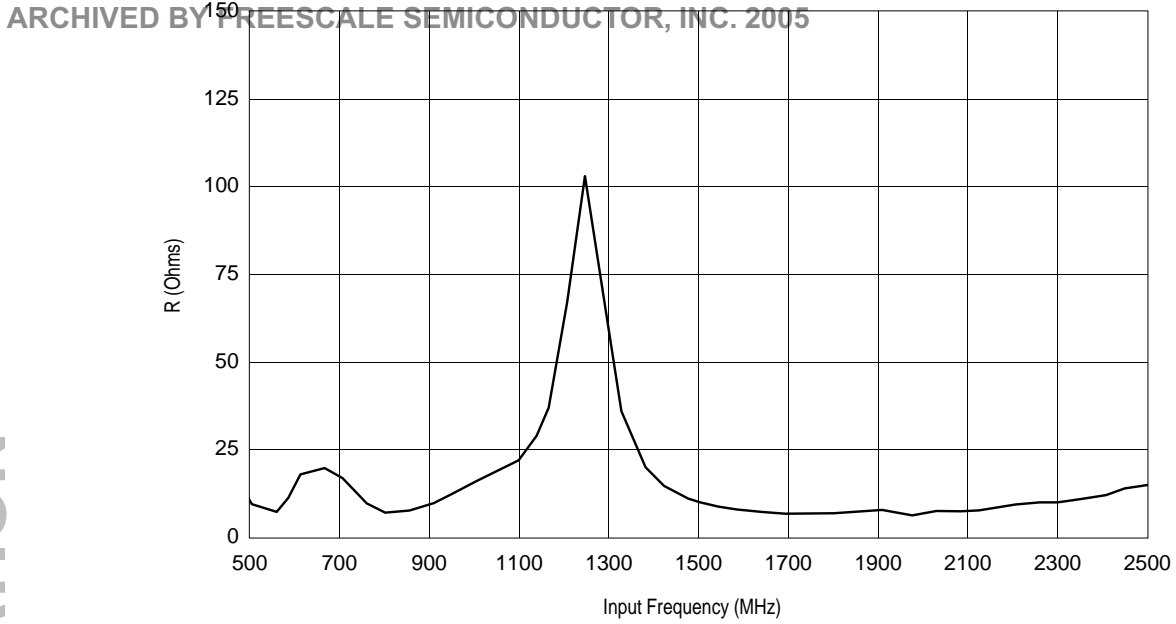
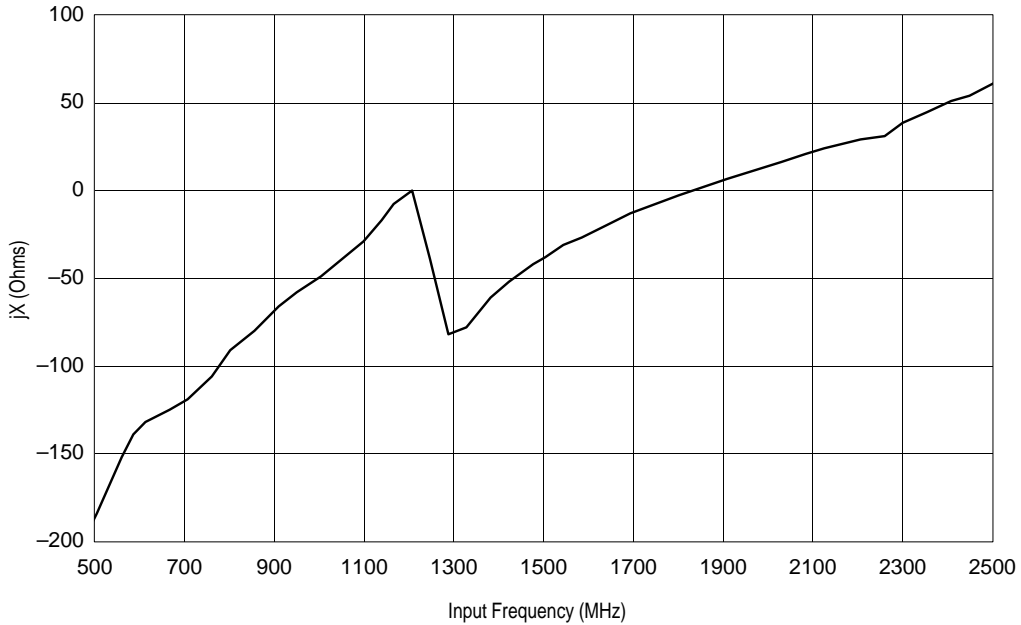

Figure 5. Input Impedance versus Frequency



Freescale Semiconductor, Inc.  
ARCHIVED BY FREESCALE SEMICONDUCTOR, INC. 2005

ARCHIVE INFORMATION

OUTLINE DIMENSIONS

ARCHIVED BY FREESCALE SEMICONDUCTOR, INC. 2005

D SUFFIX  
 PLASTIC PACKAGE  
 CASE 751-06  
 (SO-8)  
 ISSUE T

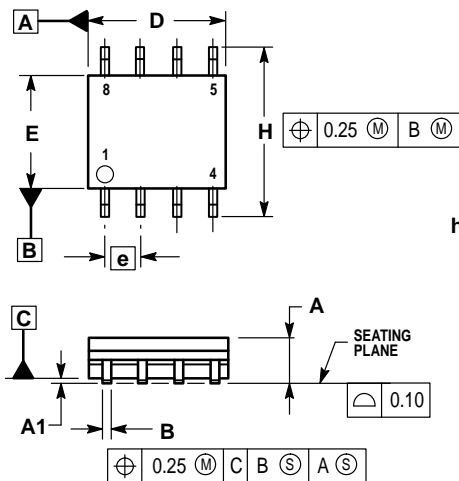

NOTES:

1. DIMENSIONING AND TOLERANCING PER ASME Y14.5M, 1994.
2. DIMENSIONS ARE IN MILLIMETER.
3. DIMENSION D AND E DO NOT INCLUDE MOLD PROTRUSION.
4. MAXIMUM MOLD PROTRUSION 0.15 PER SIDE.
5. DIMENSION B DOES NOT INCLUDE DAMBAR PROTRUSION. ALLOWABLE DAMBAR PROTRUSION SHALL BE 0.127 TOTAL IN EXCESS OF THE B DIMENSION AT MAXIMUM MATERIAL CONDITION.

DIM	MILLIMETERS	
	MIN	MAX
A	1.35	1.75
A1	0.10	0.25
B	0.35	0.49
C	0.19	0.25
D	4.80	5.00
E	3.80	4.00
e	1.27 BSC	
H	5.80	6.20
h	0.25	0.50
L	0.40	1.25
θ	0°	7°

Freescale Semiconductor, Inc.

ARCHIVE INFORMATION

ARCHIVE INFORMATION

Motorola reserves the right to make changes without further notice to any products herein. Motorola makes no warranty, representation or guarantee regarding the suitability of its products for any particular purpose, nor does Motorola assume any liability arising out of the application or use of any product or circuit, and specifically disclaims any and all liability, including without limitation consequential or incidental damages. "Typical" parameters which may be provided in Motorola data sheets and/or specifications can and do vary in different applications and actual performance may vary over time. All operating parameters, including "Typicals" must be validated for each customer application by customer's technical experts. Motorola does not convey any license under its patent rights nor the rights of others. Motorola products are not designed, intended, or authorized for use as components in systems intended for surgical implant into the body, or other applications intended to support or sustain life, or for any other application in which the failure of the Motorola product could create a situation where personal injury or death may occur. Should Buyer purchase or use Motorola products for any such unintended or unauthorized application, Buyer shall indemnify and hold Motorola and its officers, employees, subsidiaries, affiliates, and distributors harmless against all claims, costs, damages, and expenses, and reasonable attorney fees arising out of, directly or indirectly, any claim of personal injury or death associated with such unintended or unauthorized use, even if such claim alleges that Motorola was negligent regarding the design or manufacture of the part. Motorola and are registered trademarks of Motorola, Inc. Motorola, Inc. is an Equal Opportunity/Affirmative Action Employer.

Mfax is a trademark of Motorola, Inc.

**How to reach us:**

**USA/EUROPE/Locations Not Listed:** Motorola Literature Distribution; P.O. Box 5405, Denver, Colorado 80217. 1-303-675-2140 or 1-800-441-2447

**JAPAN:** Motorola Japan Ltd.; SPD, Strategic Planning Office, 141, 4-32-1 Nishi-Gotanda, Shinagawa-ku, Tokyo, Japan. 81-3-5487-8488

**Customer Focus Center: 1-800-521-6274**

**Mfax™:** RMFAX0@email.sps.mot.com – TOUCHTONE 1-602-244-6609  
 Motorola Fax Back System – US & Canada ONLY 1-800-774-1848  
 – http://sps.motorola.com/mfax/

**ASIA/PACIFIC:** Motorola Semiconductors H.K. Ltd.; 8B Tai Ping Industrial Park, 51 Ting Kok Road, Tai Po, N.T., Hong Kong. 852-26629298

**HOME PAGE:** <http://motorola.com/sps/>



For More Information On This Product,  
 Go to: [www.freescale.com](http://www.freescale.com)