

# RF Power Field Effect Transistors

## N-Channel Enhancement-Mode Lateral MOSFETs

RF Power transistors designed for CW and pulsed applications operating at 1300 MHz. These devices are suitable for use in CW and pulsed applications.

- Typical Pulsed Performance:  $V_{DD} = 50$  Volts,  $I_{DQ} = 100$  mA

Signal Type	$P_{out}$ (W)	f (MHz)	$G_{ps}$ (dB)	$\eta_D$ (%)	IRL (dB)
Pulsed (200 $\mu$ sec, 10% Duty Cycle)	250 Peak	1300	22.7	57.0	-18

- Typical CW Performance:  $V_{DD} = 50$  Volts,  $I_{DQ} = 10$  mA,  $T_C = 61^\circ\text{C}$

Signal Type	$P_{out}$ (W)	f (MHz)	$G_{ps}$ (dB)	$\eta_D$ (%)	IRL (dB)
CW	230 CW	1300	20.0	53.0	-25

- Capable of Handling a Load Mismatch of 10:1 VSWR, @ 50 Vdc, 1300 MHz at all Phase Angles, 250 Watts Pulsed Peak Power, 10% Duty Cycle, 200  $\mu$ sec

### Features

- Characterized with Series Equivalent Large-Signal Impedance Parameters
- Internally Matched for Ease of Use
- Qualified Up to a Maximum of 50  $V_{DD}$  Operation
- Characterized from 20 V to 50 V for Extended Power Range
- Integrated ESD Protection
- Greater Negative Gate-Source Voltage Range for Improved Class C Operation
- RoHS Compliant
- In Tape and Reel. R3 Suffix = 250 Units, 56 mm Tape Width, 13 inch Reel. For R5 Tape and Reel options, see p. 12.

**MRF6V13250HR3**  
**MRF6V13250HSR3**

**1300 MHz, 250 W, 50 V**  
**LATERAL N-CHANNEL**  
**RF POWER MOSFETs**

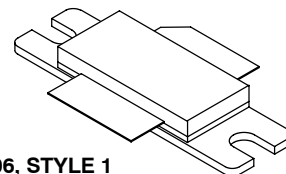

**CASE 465-06, STYLE 1**  
**NI-780**  
**MRF6V13250HR3**

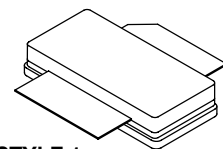

**CASE 465A-06, STYLE 1**  
**NI-780S**  
**MRF6V13250HSR3**

**Table 1. Maximum Ratings**

Rating	Symbol	Value	Unit
Drain-Source Voltage	$V_{DSS}$	-0.5, +120	Vdc
Gate-Source Voltage	$V_{GS}$	-6.0, +10	Vdc
Storage Temperature Range	$T_{stg}$	-65 to +150	$^\circ\text{C}$
Case Operating Temperature	$T_C$	150	$^\circ\text{C}$
Operating Junction Temperature (1,2)	$T_J$	225	$^\circ\text{C}$
Total Device Dissipation @ $T_C = 25^\circ\text{C}$ Derate above $25^\circ\text{C}$	$P_D$	476 2.38	W W/ $^\circ\text{C}$

**Table 2. Thermal Characteristics**

Characteristic	Symbol	Value (2,3)	Unit
Thermal Resistance, Junction to Case Pulsed: Case Temperature $65^\circ\text{C}$ , 250 W Pulsed, 200 $\mu$ sec Pulse Width, 10% Duty Cycle, 50 Vdc, $I_{DQ} = 100$ mA, 1300 MHz CW: Case Temperature $77^\circ\text{C}$ , 235 W CW, 50 Vdc, $I_{DQ} = 10$ mA, 1300 MHz	$Z_{\theta JC}$ $R_{\theta JC}$	0.07 0.42	$^\circ\text{C}/\text{W}$

1. Continuous use at maximum temperature will affect MTTF.
2. MTTF calculator available at <http://www.freescale.com/rf>. Select Software & Tools/Development Tools/Calculators to access MTTF calculators by product.
3. Refer to AN1955, *Thermal Measurement Methodology of RF Power Amplifiers*. Go to <http://www.freescale.com/rf>. Select Documentation/Application Notes - AN1955.

**Table 3. ESD Protection Characteristics**

Test Methodology	Class
Human Body Model (per JESD22-A114)	2 (Minimum)
Machine Model (per EIA/JESD22-A115)	B (Minimum)
Charge Device Model (per JESD22-C101)	IV (Minimum)

**Table 4. Electrical Characteristics** ( $T_A = 25^\circ\text{C}$  unless otherwise noted)

Characteristic	Symbol	Min	Typ	Max	Unit
----------------	--------	-----	-----	-----	------

**Off Characteristics**

Gate-Source Leakage Current ( $V_{GS} = 5\text{ Vdc}$ , $V_{DS} = 0\text{ Vdc}$ )	$I_{GSS}$	—	—	1	$\mu\text{A}$
Drain-Source Breakdown Voltage ( $V_{GS} = 0\text{ Vdc}$ , $I_D = 50\text{ mA}$ )	$V_{(BR)DSS}$	120	—	—	Vdc
Zero Gate Voltage Drain Leakage Current ( $V_{DS} = 50\text{ Vdc}$ , $V_{GS} = 0\text{ Vdc}$ )	$I_{DSS}$	—	—	10	$\mu\text{A}$
Zero Gate Voltage Drain Leakage Current ( $V_{DS} = 90\text{ Vdc}$ , $V_{GS} = 0\text{ Vdc}$ )	$I_{DSS}$	—	—	20	$\mu\text{A}$

**On Characteristics**

Gate Threshold Voltage ( $V_{DS} = 10\text{ Vdc}$ , $I_D = 640\ \mu\text{A}$ )	$V_{GS(th)}$	1.0	1.8	2.7	Vdc
Gate Quiescent Voltage ( $V_{DD} = 50\text{ Vdc}$ , $I_D = 100\text{ mA}$ , Measured in Functional Test)	$V_{GS(Q)}$	2.0	2.4	3.0	Vdc
Drain-Source On-Voltage ( $V_{GS} = 10\text{ Vdc}$ , $I_D = 1.58\text{ A}$ )	$V_{DS(on)}$	0.1	0.25	0.3	Vdc

**Dynamic Characteristics (1)**

Reverse Transfer Capacitance ( $V_{DS} = 50\text{ Vdc} \pm 30\text{ mV(rms)}$ ac @ 1 MHz, $V_{GS} = 0\text{ Vdc}$ )	$C_{rss}$	—	1.2	—	pF
Output Capacitance ( $V_{DS} = 50\text{ Vdc} \pm 30\text{ mV(rms)}$ ac @ 1 MHz, $V_{GS} = 0\text{ Vdc}$ )	$C_{oss}$	—	58	—	pF
Input Capacitance ( $V_{DS} = 50\text{ Vdc}$ , $V_{GS} = 0\text{ Vdc} \pm 30\text{ mV(rms)}$ ac @ 1 MHz)	$C_{iss}$	—	340	—	pF

**Functional Tests** (In Freescale Test Fixture, 50 ohm system)  $V_{DD} = 50\text{ Vdc}$ ,  $I_{DQ} = 100\text{ mA}$ ,  $P_{out} = 250\text{ W Peak}$  (25 W Avg.),  $f = 1300\text{ MHz}$  Pulsed, 200  $\mu\text{sec}$  Pulse Width, 10% Duty Cycle

Power Gain	$G_{ps}$	21.5	22.7	24.0	dB
Drain Efficiency	$\eta_D$	53.5	57.0	—	%
Input Return Loss	IRL	—	-18	-9	dB

**Typical CW Performance** (In Freescale Test Fixture, 50 ohm system)  $V_{DD} = 50\text{ Vdc}$ ,  $I_{DQ} = 10\text{ mA}$ ,  $P_{out} = 230\text{ W CW}$ ,  $f = 1300\text{ MHz}$ ,  $T_C = 61^\circ\text{C}$

Power Gain	$G_{ps}$	—	20.0	—	dB
Drain Efficiency	$\eta_D$	—	53.0	—	%
Input Return Loss	IRL	—	-25	—	dB

**Load Mismatch** (In Freescale Application Test Fixture, 50 ohm system)  $V_{DD} = 50\text{ Vdc}$ ,  $I_{DQ} = 100\text{ mA}$ ,  $P_{out} = 250\text{ W Peak}$  (25 W Avg.),  $f = 1300\text{ MHz}$ , Pulsed, 200  $\mu\text{sec}$  Pulse Width, 10% Duty Cycle

VSWR 10:1 at all Phase Angles	$\Psi$	No Degradation in Output Power			
-------------------------------	--------	--------------------------------	--	--	--

1. Part internally input matched.

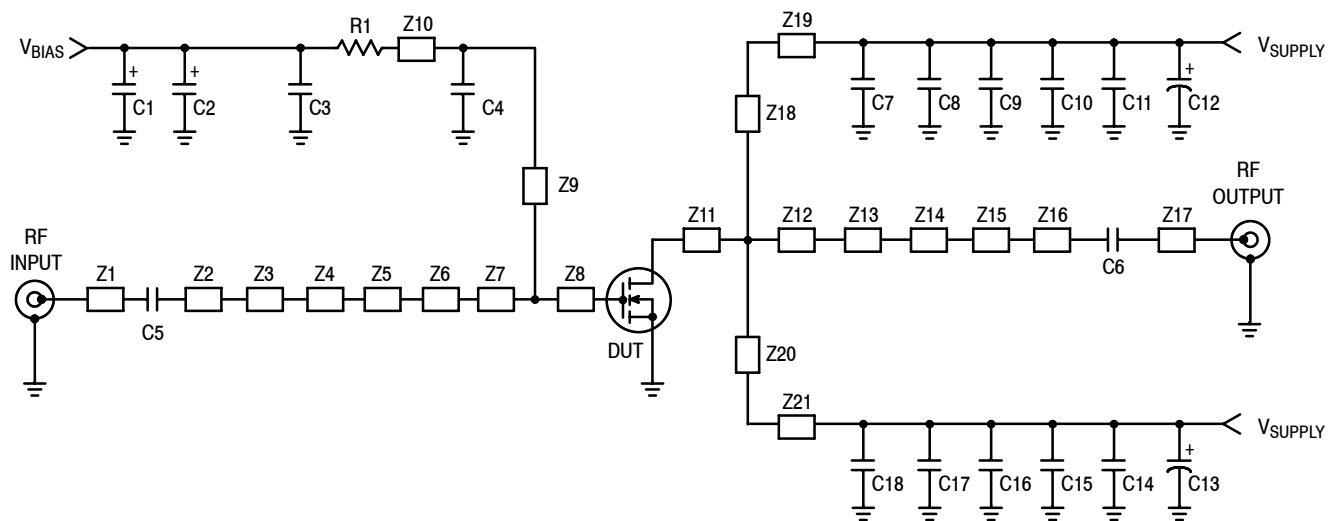

Z1	0.447" x 0.063" Microstrip	Z11	0.162" x 1.160" Microstrip
Z2	0.030" x 0.084" Microstrip	Z12	0.419" x 1.160" Microstrip
Z3	0.120" x 0.063" Microstrip	Z13	0.468" x 0.994" Microstrip
Z4	0.855" x 0.293" Microstrip	Z14	0.131" x 0.472" Microstrip
Z5	0.369" x 0.825" Microstrip	Z15	0.264" x 0.222" Microstrip
Z6	0.203" x 0.516" Microstrip	Z16	0.500" x 0.111" Microstrip
Z7	0.105" x 0.530" Microstrip	Z17	0.291" x 0.063" Microstrip
Z8	0.105" x 0.530" Microstrip	Z18, Z20	0.105" x 0.388" Microstrip
Z9*	0.116" x 0.050" Microstrip	Z19*, Z21*	0.854" x 0.052" Microstrip
Z10	0.122" x 0.050" Microstrip		

\*Line length includes microstrip bends.

Figure 1. MRF6V13250HR3(HSR3) Test Circuit Schematic — 1300 MHz

Table 5. MRF6V13250HR3(HSR3) Test Circuit Component Designations and Values — 1300 MHz

Part	Description	Part Number	Manufacturer
C1, C2	22 $\mu$ F, 35 V Tantalum Capacitors	T491X226K035AT	Kemet
C3, C11, C14	0.1 $\mu$ F, 50 V Chip Capacitors	CDR33BX104AKWS	AVX
C4, C6, C7, C18	100 pF Chip Capacitors	ATC800B101JT500XT	ATC
C5	4.7 pF Chip Capacitor	ATC100B4R7CT500XT	ATC
C8, C17	1000 pF Chip Capacitors	ATC100B102JT50XT	ATC
C9, C16	1000 pF Chip Capacitors	ATC700B102FT50XT	ATC
C10, C15	10K pF Chip Capacitors	ATC200B103KT50XT	ATC
C12, C13	470 $\mu$ F, 63 V Electrolytic Capacitors	MCGPR63V477M13X26-RH	Multicomp
R1	15 $\Omega$ , 1/4 W Chip Resistor	CRCW120615R0FKEA	Vishay
PCB	0.030", $\epsilon_r = 3.50$	RO4350B	Rogers

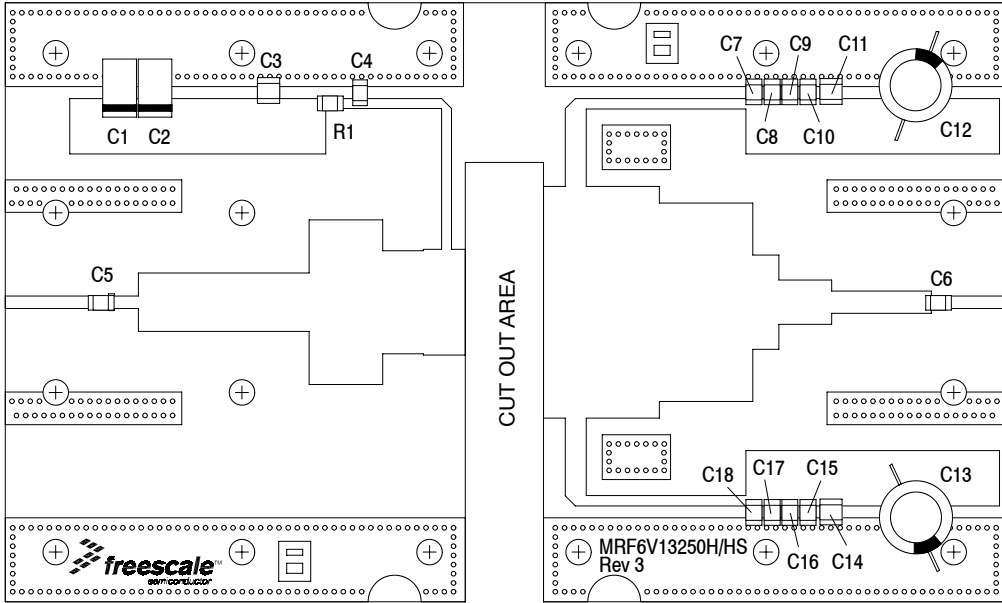

Figure 2. MRF6V13250HR3(HSR3) Test Circuit Component Layout — 1300 MHz

TYPICAL CHARACTERISTICS — PULSED

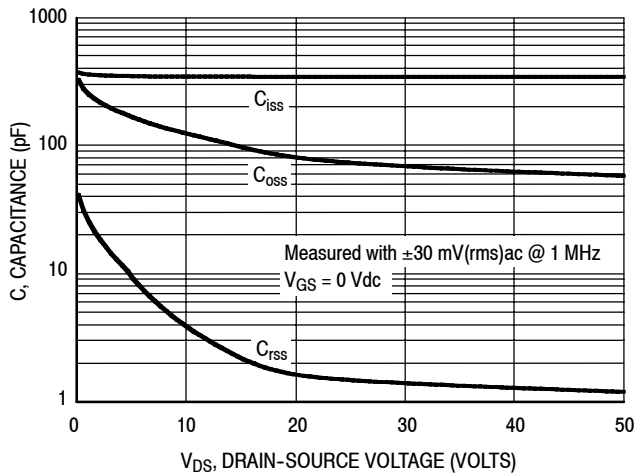

Figure 3. Capacitance versus Drain-Source Voltage

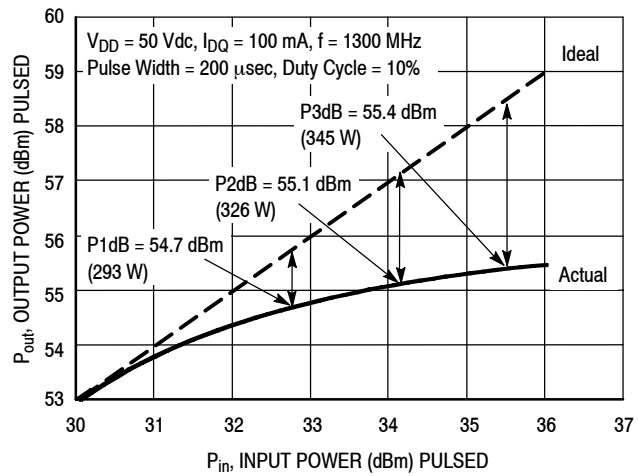

Figure 4. Pulsed Output Power versus Input Power

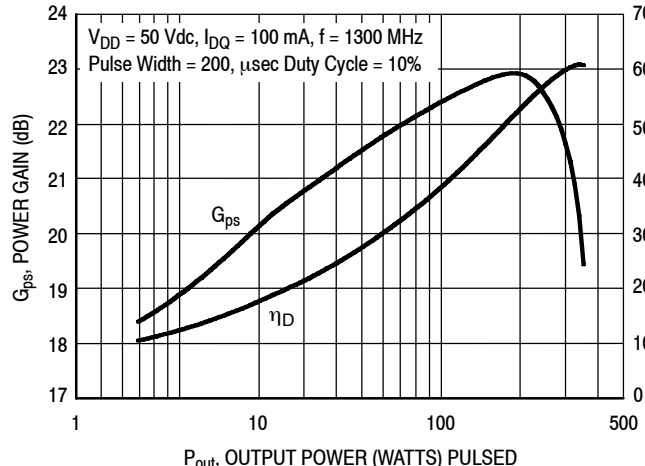

Figure 5. Pulsed Power Gain and Drain Efficiency versus Output Power

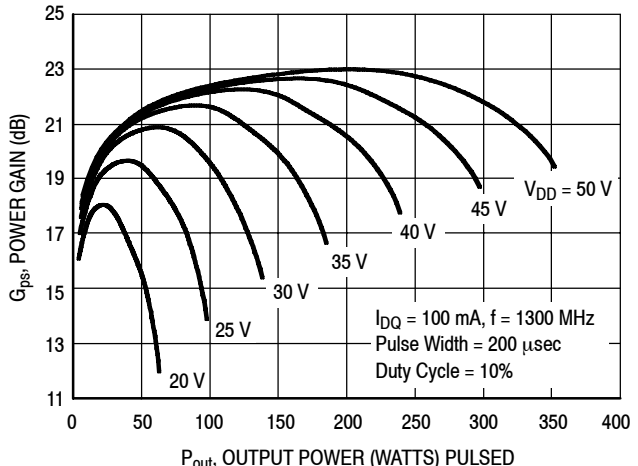

Figure 6. Pulsed Power Gain versus Output Power

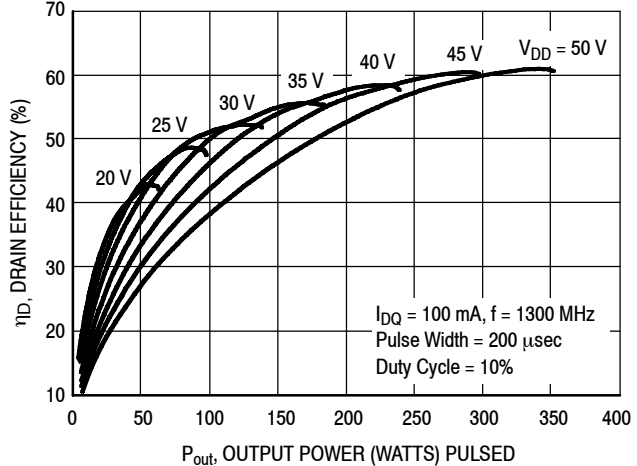

Figure 7. Pulsed Efficiency versus Output Power

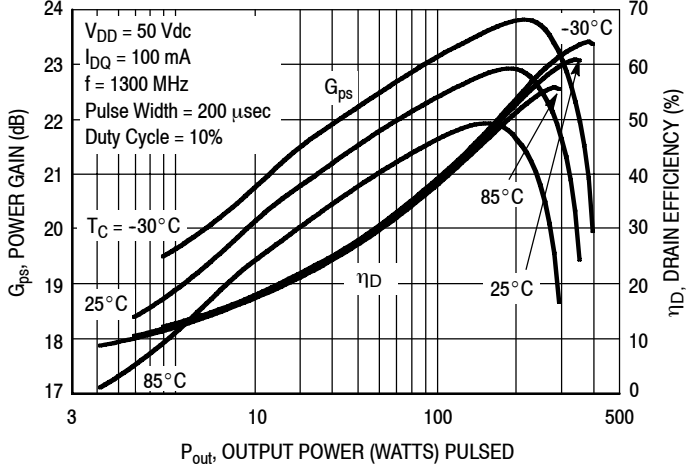
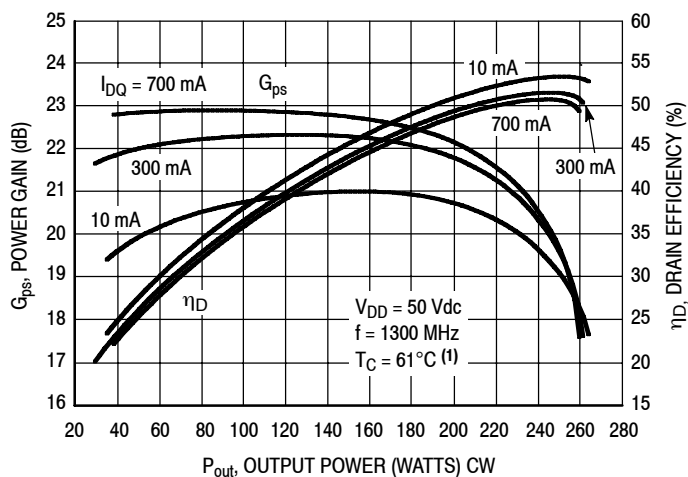

Figure 8. Pulsed Power Gain and Drain Efficiency versus Output Power

### TYPICAL CHARACTERISTICS — CW



1. Data for graph was collected in a water cooled test fixture. The water inlet temperature = 25°C.

**Figure 9. CW Power Gain and Drain Efficiency versus Output Power**

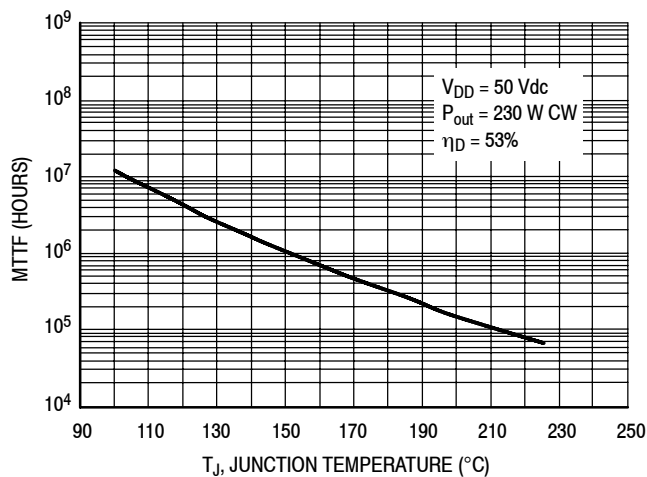

MTTF calculator available at <http://www.freescale.com/rf>. Select Software & Tools/Development Tools/Calculators to access MTTF calculators by product.

**Figure 10. MTTF versus Junction Temperature — CW**

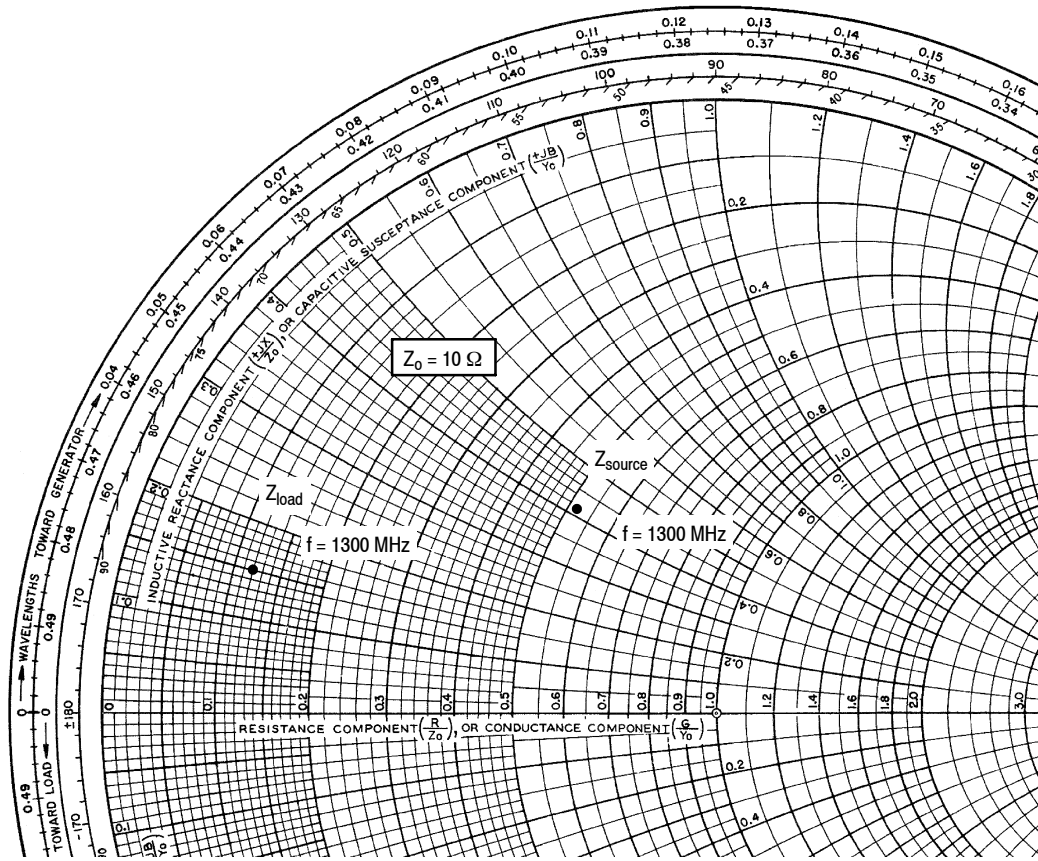

$V_{DD} = 50 \text{ Vdc}$ ,  $I_{DQ} = 100 \text{ mA}$ ,  $P_{out} = 250 \text{ W Peak}$

f MHz	$Z_{source}$ $\Omega$	$Z_{load}$ $\Omega$
1300	$5.32 + j4.11$	$1.17 + j1.48$

$Z_{source}$  = Test circuit impedance as measured from gate to ground.

$Z_{load}$  = Test circuit impedance as measured from drain to ground.

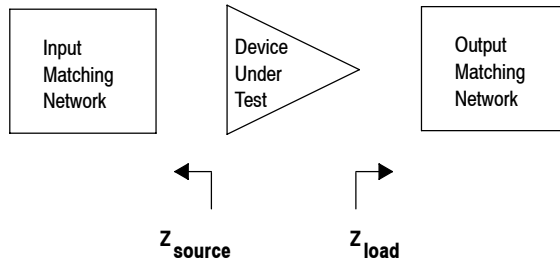
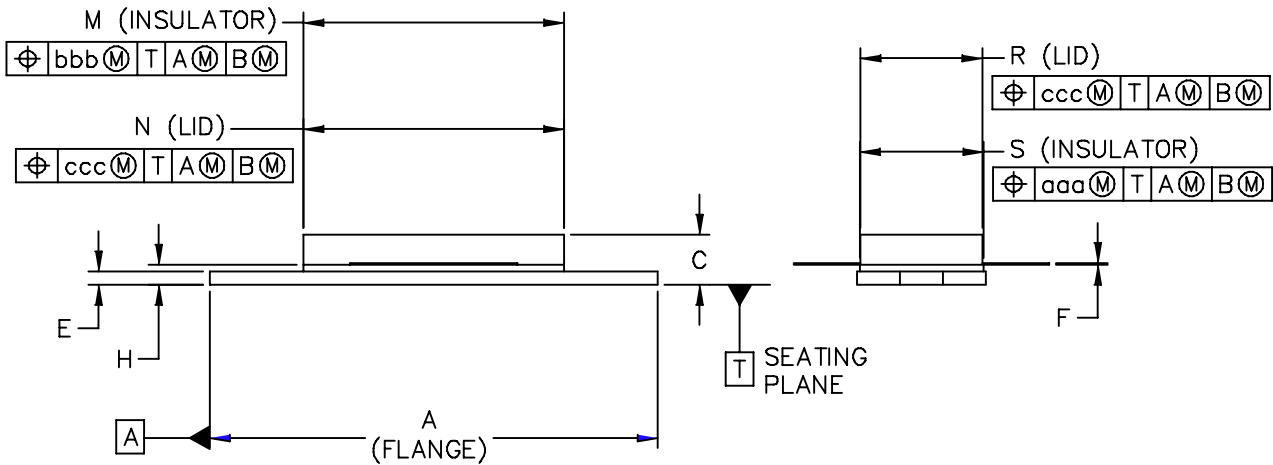
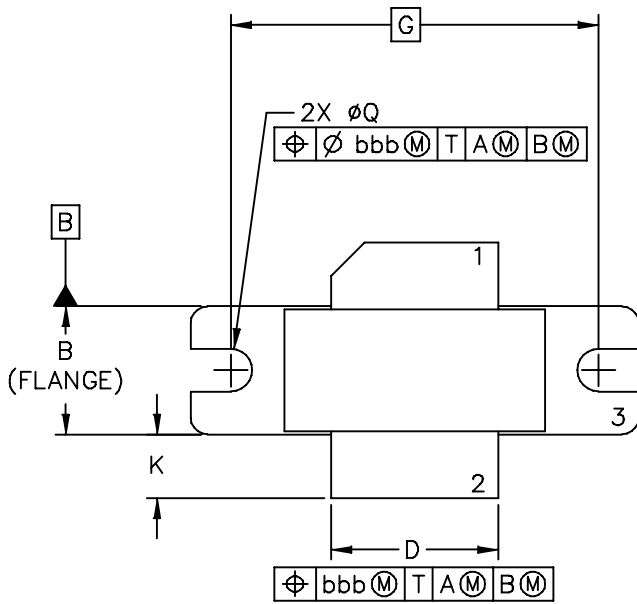

Figure 11. Series Equivalent Source and Load Impedance — Pulsed

PACKAGE DIMENSIONS



© FREESCALE SEMICONDUCTOR, INC. ALL RIGHTS RESERVED.		MECHANICAL OUTLINE	PRINT VERSION NOT TO SCALE
TITLE:  NI-780		DOCUMENT NO: 98ASB15607C	REV: G
		CASE NUMBER: 465-06	31 MAR 2005
		STANDARD: NON-JEDEC	



NOTES:

1. DIMENSIONING AND TOLERANCING PER ANSI Y14.5M-1994.
2. CONTROLLING DIMENSION: INCH.
3. DELETED
4. DIMENSION H IS MEASURED .030 (.762) AWAY FROM PACKAGE BODY.

STYLE 1:

- PIN 1. DRAIN  
 2. GATE  
 3. SOURCE

DIM	INCH		MILLIMETER		DIM	INCH		MILLIMETER	
	MIN	MAX	MIN	MAX		MIN	MAX	MIN	MAX
A	1.335	1.345	33.91	34.16	R	.365	.375	9.27	9.53
B	.380	.390	9.65	9.91	S	.365	.375	9.27	9.52
C	.125	.170	3.18	4.32	aaa	—	.005	—	0.127
D	.495	.505	12.57	12.83	bbb	—	.010	—	0.254
E	.035	.045	0.89	1.14	ccc	—	.015	—	0.381
F	.003	.006	0.08	0.15	—	—	—	—	—
G	1.100 BSC		27.94 BSC		—	—	—	—	—
H	.057	.067	1.45	1.7	—	—	—	—	—
K	.170	.210	4.32	5.33	—	—	—	—	—
M	.774	.786	19.66	19.96	—	—	—	—	—
N	.772	.788	19.6	20	—	—	—	—	—
Q	∅.118	∅.138	∅3	∅3.51	—	—	—	—	—
© FREESCALE SEMICONDUCTOR, INC. ALL RIGHTS RESERVED.			MECHANICAL OUTLINE			PRINT VERSION NOT TO SCALE			
TITLE:  NI-780					DOCUMENT NO: 98ASB15607C			REV: G	
					CASE NUMBER: 465-06			31 MAR 2005	
					STANDARD: NON-JEDEC				

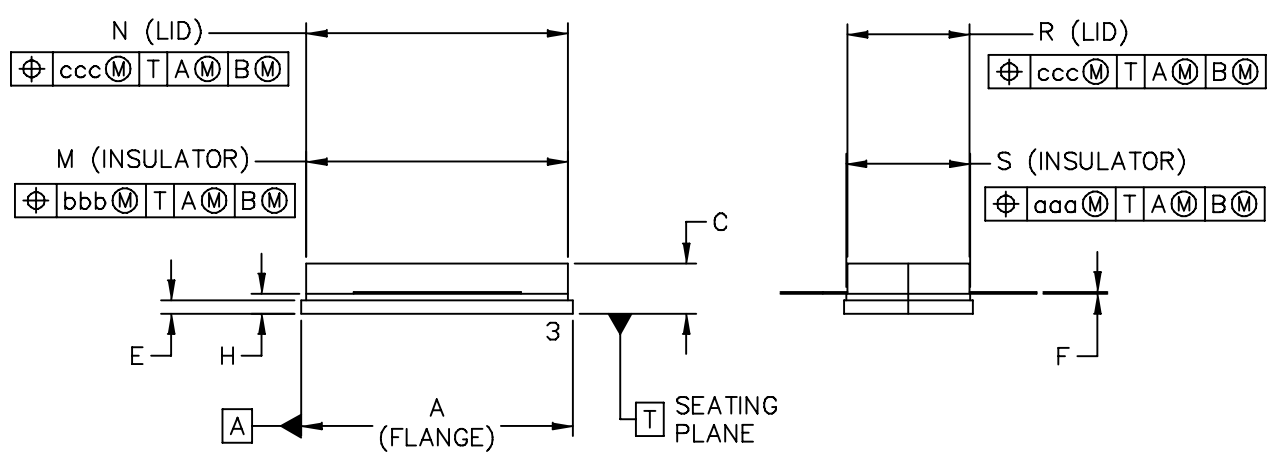
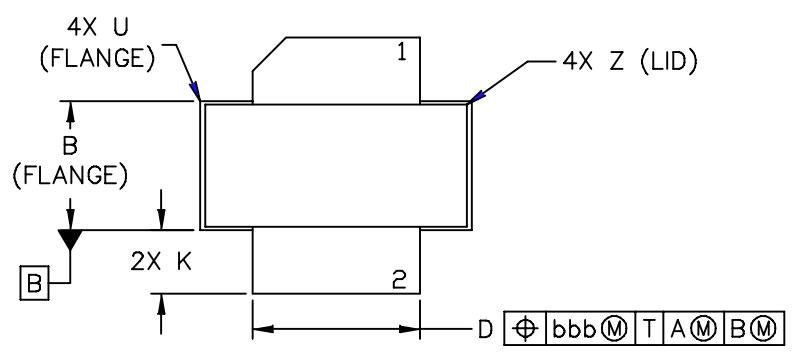

© FREESCALE SEMICONDUCTOR, INC. ALL RIGHTS RESERVED.	MECHANICAL OUTLINE	PRINT VERSION NOT TO SCALE	
TITLE:  NI-780S	DOCUMENT NO: 98ASB16718C	REV: H	
	CASE NUMBER: 465A-06	31 MAR 2005	
	STANDARD: NON-JEDEC		

NOTES:

1. DIMENSIONING AND TOLERANCING PER ANSI Y14.5M-1994.
2. CONTROLLING DIMENSION: INCH.
3. DELETED
4. DIMENSION H IS MEASURED .030 (0.762) AWAY FROM PACKAGE BODY.

STYLE 1:

- PIN 1. DRAIN
2. GATE
3. SOURCE

DIM	INCH		MILLIMETER		DIM	INCH		MILLIMETER	
	MIN	MAX	MIN	MAX		MIN	MAX	MIN	MAX
A	.805	-.815	20.45	20.7	U	-.040	-	-	1.02
B	.380	-.390	9.65	9.91	Z	-.030	-	-	0.76
C	.125	-.170	3.18	4.32	aaa	-.005	-	-	0.127
D	.495	-.505	12.57	12.83	bbb	-.010	-	-	0.254
E	.035	-.045	0.89	1.14	ccc	-.015	-	-	0.381
F	.003	-.006	0.08	0.15	-	-	-	-	-
H	.057	-.067	1.45	1.7	-	-	-	-	-
K	.170	-.210	4.32	5.33	-	-	-	-	-
M	.774	-.786	19.61	20.02	-	-	-	-	-
N	.772	-.788	19.61	20.02	-	-	-	-	-
R	.365	-.375	9.27	9.53	-	-	-	-	-
S	.365	-.375	9.27	9.52	-	-	-	-	-

© FREESCALE SEMICONDUCTOR, INC. ALL RIGHTS RESERVED.		MECHANICAL OUTLINE		PRINT VERSION NOT TO SCALE	
TITLE:  NI-780S		DOCUMENT NO: 98ASB16718C		REV: H	
		CASE NUMBER: 465A-06		31 MAR 2005	
		STANDARD: NON-JEDEC			

## PRODUCT DOCUMENTATION AND SOFTWARE

Refer to the following documents and software to aid your design process.

### Application Notes

- AN1955: Thermal Measurement Methodology of RF Power Amplifiers

### Engineering Bulletins

- EB212: Using Data Sheet Impedances for RF LDMOS Devices

### Software

- Electromigration MTTF Calculator
- RF High Power Model
- .s2p File

For Software, do a Part Number search at <http://www.freescale.com>, and select the “Part Number” link. Go to the Software & Tools tab on the part’s Product Summary page to download the respective tool.

## R5 TAPE AND REEL OPTION

R5 Suffix = 50 Units, 56 mm Tape Width, 13 inch Reel.

The R5 tape and reel option for MRF6V13250H and MRF6V13250HS parts will be available for 2 years after release of MRF6V13250H and MRF6V13250HS. Freescale Semiconductor, Inc. reserves the right to limit the quantities that will be delivered in the R5 tape and reel option. At the end of the 2 year period customers who have purchased these devices in the R5 tape and reel option will be offered MRF6V13250H and MRF6V13250HS in the R3 tape and reel option.

## REVISION HISTORY

The following table summarizes revisions to this document.

Revision	Date	Description
0	June 2011	<ul style="list-style-type: none"> <li>• Initial Release of Data Sheet</li> </ul>
1	July 2011	<ul style="list-style-type: none"> <li>• Added CW information to data sheet including:                             <ul style="list-style-type: none"> <li>- Typical Performance Frequency tables, p. 1, 2</li> <li>- CW Capable bullet and Thermal Characteristics, p. 1</li> <li>- Fig. 9, CW Power Gain and Drain Efficiency versus Output Power, p. 6</li> <li>- Fig. 10, MTTF versus Junction Temperature - CW, p. 6</li> </ul> </li> </ul>

## **How to Reach Us:**

### **Home Page:**

[www.freescale.com](http://www.freescale.com)

### **Web Support:**

<http://www.freescale.com/support>

### **USA/Europe or Locations Not Listed:**

Freescale Semiconductor, Inc.  
Technical Information Center, EL516  
2100 East Elliot Road  
Tempe, Arizona 85284  
1-800-521-6274 or +1-480-768-2130  
[www.freescale.com/support](http://www.freescale.com/support)

### **Europe, Middle East, and Africa:**

Freescale Halbleiter Deutschland GmbH  
Technical Information Center  
Schatzbogen 7  
81829 Muenchen, Germany  
+44 1296 380 456 (English)  
+46 8 52200080 (English)  
+49 89 92103 559 (German)  
+33 1 69 35 48 48 (French)  
[www.freescale.com/support](http://www.freescale.com/support)

### **Japan:**

Freescale Semiconductor Japan Ltd.  
Headquarters  
ARCO Tower 15F  
1-8-1, Shimo-Meguro, Meguro-ku,  
Tokyo 153-0064  
Japan  
0120 191014 or +81 3 5437 9125  
[support.japan@freescale.com](mailto:support.japan@freescale.com)

### **Asia/Pacific:**

Freescale Semiconductor China Ltd.  
Exchange Building 23F  
No. 118 Jianguo Road  
Chaoyang District  
Beijing 100022  
China  
+86 10 5879 8000  
[support.asia@freescale.com](mailto:support.asia@freescale.com)

### **For Literature Requests Only:**

Freescale Semiconductor Literature Distribution Center  
1-800-441-2447 or +1-303-675-2140  
Fax: +1-303-675-2150  
[LDCForFreescaleSemiconductor@hibbertgroup.com](mailto:LDCForFreescaleSemiconductor@hibbertgroup.com)

Information in this document is provided solely to enable system and software implementers to use Freescale Semiconductor products. There are no express or implied copyright licenses granted hereunder to design or fabricate any integrated circuits or integrated circuits based on the information in this document.

Freescale Semiconductor reserves the right to make changes without further notice to any products herein. Freescale Semiconductor makes no warranty, representation or guarantee regarding the suitability of its products for any particular purpose, nor does Freescale Semiconductor assume any liability arising out of the application or use of any product or circuit, and specifically disclaims any and all liability, including without limitation consequential or incidental damages. "Typical" parameters that may be provided in Freescale Semiconductor data sheets and/or specifications can and do vary in different applications and actual performance may vary over time. All operating parameters, including "Typicals", must be validated for each customer application by customer's technical experts. Freescale Semiconductor does not convey any license under its patent rights nor the rights of others. Freescale Semiconductor products are not designed, intended, or authorized for use as components in systems intended for surgical implant into the body, or other applications intended to support or sustain life, or for any other application in which the failure of the Freescale Semiconductor product could create a situation where personal injury or death may occur. Should Buyer purchase or use Freescale Semiconductor products for any such unintended or unauthorized application, Buyer shall indemnify and hold Freescale Semiconductor and its officers, employees, subsidiaries, affiliates, and distributors harmless against all claims, costs, damages, and expenses, and reasonable attorney fees arising out of, directly or indirectly, any claim of personal injury or death associated with such unintended or unauthorized use, even if such claim alleges that Freescale Semiconductor was negligent regarding the design or manufacture of the part.

Freescale™ and the Freescale logo are trademarks of Freescale Semiconductor, Inc. All other product or service names are the property of their respective owners.

© Freescale Semiconductor, Inc. 2011. All rights reserved.