

RF Power Field Effect Transistor

N-Channel Enhancement-Mode Lateral MOSFET

Designed for broadband commercial and industrial applications with frequencies from 865 to 895 MHz. The high gain and broadband performance of this device make it ideal for large-signal, common-source amplifier applications in 26 volt base station equipment.

- Typical N-CDMA Performance @ 880 MHz, 26 Volts, $I_{DQ} = 1100$ mA
IS-95 CDMA Pilot, Sync, Paging, Traffic Codes 8 Through 13
Output Power — 25 Watts Avg.
Power Gain — 17.8 dB
Efficiency — 25%
Adjacent Channel Power —
750 kHz: -47 dBc @ 30 kHz BW
- Capable of Handling 10:1 VSWR, @ 26 Vdc, 880 MHz, 135 Watts CW Output Power

Features

- Internally Matched for Ease of Use
- High Gain, High Efficiency and High Linearity
- Integrated ESD Protection
- Designed for Maximum Gain and Insertion Phase Flatness
- Excellent Thermal Stability
- Characterized with Series Equivalent Large-Signal Impedance Parameters
- Low Gold Plating Thickness on Leads, 40 μ " Nominal.
- RoHS Compliant
- In Tape and Reel. R3 Suffix = 250 Units per 32 mm, 13 inch Reel.

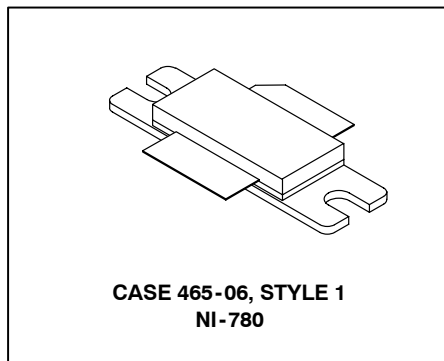
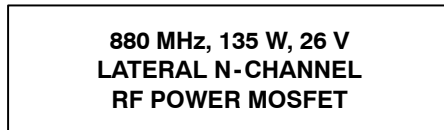
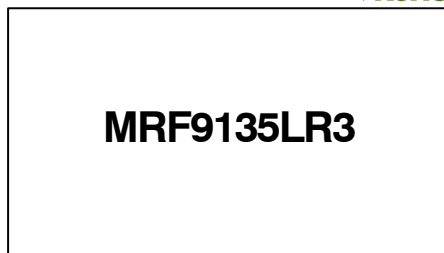

LIFETIME BUY

LAST SHIP 14 MAY 09
LAST ORDER 3 OCT 08

Table 1. Maximum Ratings

Rating	Symbol	Value	Unit
Drain-Source Voltage	V_{DSS}	- 0.5, +65	Vdc
Gate-Source Voltage	V_{GS}	- 0.5, +15	Vdc
Total Device Dissipation @ $T_C = 25^\circ\text{C}$ Derate above 25 $^\circ\text{C}$	P_D	298 1.7	W W/ $^\circ\text{C}$
Storage Temperature Range	T_{stg}	- 65 to +200	$^\circ\text{C}$
Case Operating Temperature	T_C	150	$^\circ\text{C}$
Operating Junction Temperature	T_J	200	$^\circ\text{C}$

Table 2. Thermal Characteristics

Characteristic	Symbol	Value (1)	Unit
Thermal Resistance, Junction to Case	$R_{\theta JC}$	0.6	$^\circ\text{C}/\text{W}$

Table 3. ESD Protection Characteristics

Test Conditions	Class
Human Body Model	1 (Minimum)
Machine Model	M2 (Minimum)
Charge Device Model	C7 (Minimum)

1. MTTF calculator available at <http://www.freescale.com/rf>. Select Software & Tools/Development Tools/Calculators to access MTTF calculators by product.

Table 4. Electrical Characteristics ($T_C = 25^\circ\text{C}$, 50 ohm system unless otherwise noted)

Characteristic	Symbol	Min	Typ	Max	Unit
Off Characteristics					
Zero Gate Voltage Drain Leakage Current ($V_{DS} = 65\text{ Vdc}$, $V_{GS} = 0\text{ Vdc}$)	I_{DSS}	—	—	10	μAdc
Zero Gate Voltage Drain Leakage Current ($V_{DS} = 26\text{ Vdc}$, $V_{GS} = 0\text{ Vdc}$)	I_{DSS}	—	—	1	μAdc
Gate-Source Leakage Current ($V_{GS} = 5\text{ Vdc}$, $V_{DS} = 0\text{ Vdc}$)	I_{GSS}	—	—	1	μAdc
On Characteristics					
Gate Threshold Voltage ($V_{DS} = 10\text{ Vdc}$, $I_D = 450\ \mu\text{A}$)	$V_{GS(th)}$	2	2.8	4	Vdc
Gate Quiescent Voltage ($V_{DS} = 26\text{ Vdc}$, $I_D = 1100\text{ mAdc}$)	$V_{GS(Q)}$	3.25	3.7	5	Vdc
Drain-Source On-Voltage ($V_{GS} = 10\text{ Vdc}$, $I_D = 3\text{ Adc}$)	$V_{DS(on)}$	—	0.19	0.4	Vdc
Forward Transconductance ($V_{DS} = 10\text{ Vdc}$, $I_D = 9\text{ Adc}$)	g_{fs}	—	12	—	S
Dynamic Characteristics					
Output Capacitance ($V_{DS} = 26\text{ Vdc} \pm 30\text{ mV(rms)ac}$ @ 1 MHz, $V_{GS} = 0\text{ Vdc}$)	C_{oss}	—	109	—	pF
Reverse Transfer Capacitance ($V_{DS} = 26\text{ Vdc} \pm 30\text{ mV(rms)ac}$ @ 1 MHz, $V_{GS} = 0\text{ Vdc}$)	C_{rss}	—	4.4	—	pF
Functional Tests (In Freescale Test Fixture, 50 ohm system) Single-Carrier N-CDMA, 1.2288 MHz Channel Bandwidth Carrier, PAR = 9.8 dB @ 0.01% Probability on CCDF					
Common-Source Amplifier Power Gain ($V_{DD} = 26\text{ Vdc}$, $P_{out} = 25\text{ W Avg. N-CDMA}$, $I_{DQ} = 1100\text{ mA}$, $f = 880.0\text{ MHz}$)	G_{ps}	16	17.8	—	dB
Drain Efficiency ($V_{DD} = 26\text{ Vdc}$, $P_{out} = 25\text{ W Avg. N-CDMA}$, $I_{DQ} = 1100\text{ mA}$, $f = 880.0\text{ MHz}$)	η	22	25	—	%
Adjacent Channel Power Ratio ($V_{DD} = 26\text{ Vdc}$, $P_{out} = 25\text{ W Avg. N-CDMA}$, $I_{DQ} = 1100\text{ mA}$, $f = 880.0\text{ MHz}$; ACPR @ 25 W, 1.23 MHz Bandwidth, 750 kHz Channel Spacing)	ACPR	—	-47	-45	dBc
Input Return Loss ($V_{DD} = 26\text{ Vdc}$, $P_{out} = 25\text{ W Avg. N-CDMA}$, $I_{DQ} = 1100\text{ mA}$, $f = 880.0\text{ MHz}$)	IRL	—	-13.5	-9	dB
Common-Source Amplifier Power Gain ($V_{DD} = 26\text{ Vdc}$, $P_{out} = 25\text{ W Avg. N-CDMA}$, $I_{DQ} = 1100\text{ mA}$, $f = 865\text{ MHz}$ and 895 MHz)	G_{ps}	—	17	—	dB
Drain Efficiency ($V_{DD} = 26\text{ Vdc}$, $P_{out} = 25\text{ W Avg. N-CDMA}$, $I_{DQ} = 1100\text{ mA}$, $f = 865\text{ MHz}$ and 895 MHz)	η	—	24	—	%
Adjacent Channel Power Ratio ($V_{DD} = 26\text{ Vdc}$, $P_{out} = 25\text{ W Avg. N-CDMA}$, $I_{DQ} = 1100\text{ mA}$, $f = 865\text{ MHz}$ and 895 MHz ; ACPR @ 25 W, 1.23 MHz Bandwidth, 750 kHz Channel Spacing)	ACPR	—	-46	—	dBc
Input Return Loss ($V_{DD} = 26\text{ Vdc}$, $P_{out} = 25\text{ W Avg. N-CDMA}$, $I_{DQ} = 1100\text{ mA}$, $f = 865\text{ MHz}$ and 895 MHz)	IRL	—	-12.5	—	dB

LIFETIME BUY

LAST ORDER 3 OCT 08 LAST SHIP 14 MAY 09

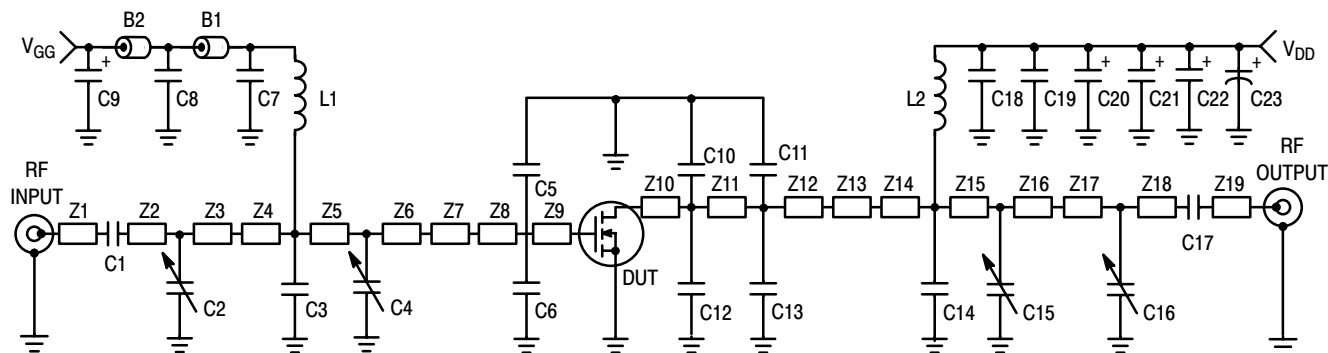

Z1	0.430" x 0.080" Microstrip	Z11	0.105" x 0.630" Microstrip
Z2	0.430" x 0.080" Microstrip	Z12	0.145" x 0.630" Microstrip
Z3	0.800" x 0.080" Microstrip	Z13	0.200" x 0.630" x 0.220" Taper
Z4	0.200" x 0.220" Microstrip	Z14	0.180" x 0.220" Microstrip
Z5	0.110" x 0.220" Microstrip	Z15	0.110" x 0.220" Microstrip
Z6	0.175" x 0.220" Microstrip	Z16	0.200" x 0.220" Microstrip
Z7	0.200" x 0.220" x 0.630" Taper	Z17	0.900" x 0.080" Microstrip
Z8	0.250" x 0.630" Microstrip	Z18	0.360" x 0.080" Microstrip
Z9	0.050" x 0.630" Microstrip	Z19	0.410" x 0.080" Microstrip
Z10	0.050" x 0.630" Microstrip	PCB	Arlon GX-0300-55-22, 0.030", $\epsilon_r = 2.55$

Figure 1. 880 MHz Test Circuit Schematic

Table 5. 880 MHz Test Circuit Component Designations and Values

Part	Description	Part Number	Manufacturer
B1, B2	Ferrite Beads, Short	2743019447	Fair-Rite
C1, C7, C17, C18	47 pF Chip Capacitors	ATC100B470JT500XT	ATC
C2, C16	0.6-4.5 Variable Capacitors, Gigatrim	27271SL	Johanson
C3	8.2 pF Chip Capacitor	ATC100B8R2BT500XT	ATC
C4, C15	0.8-8.0 Variable Capacitors, Gigatrim	27291SL	Johanson
C5, C6	12 pF Chip Capacitors	ATC100B120JT500XT	ATC
C8	20K pF Chip Capacitor	ATC200B203MT50XT	ATC
C9, C20, C21, C22	10 μ F, 35 V Tantalum Capacitors	T491D106K035AT	Kemet
C10, C11, C12, C13	7.5 pF Chip Capacitors	ATC100B7R5JT500XT	ATC
C14	11 pF Chip Capacitor	ATC100B110JT500XT	ATC
C19	0.56 μ F, 50 V Chip Capacitor	C1825C564K5RA7800	Kemet
C23	470 μ F, 63 V Electrolytic Capacitor	ESME630ELL471MK25S	United Chemi-Con
L1, L2	12.5 nH Coilcraft inductors	A04T-5	Coilcraft

LIFETIME BUY

LAST ORDER 3 OCT 08 LAST SHIP 14 MAY 09

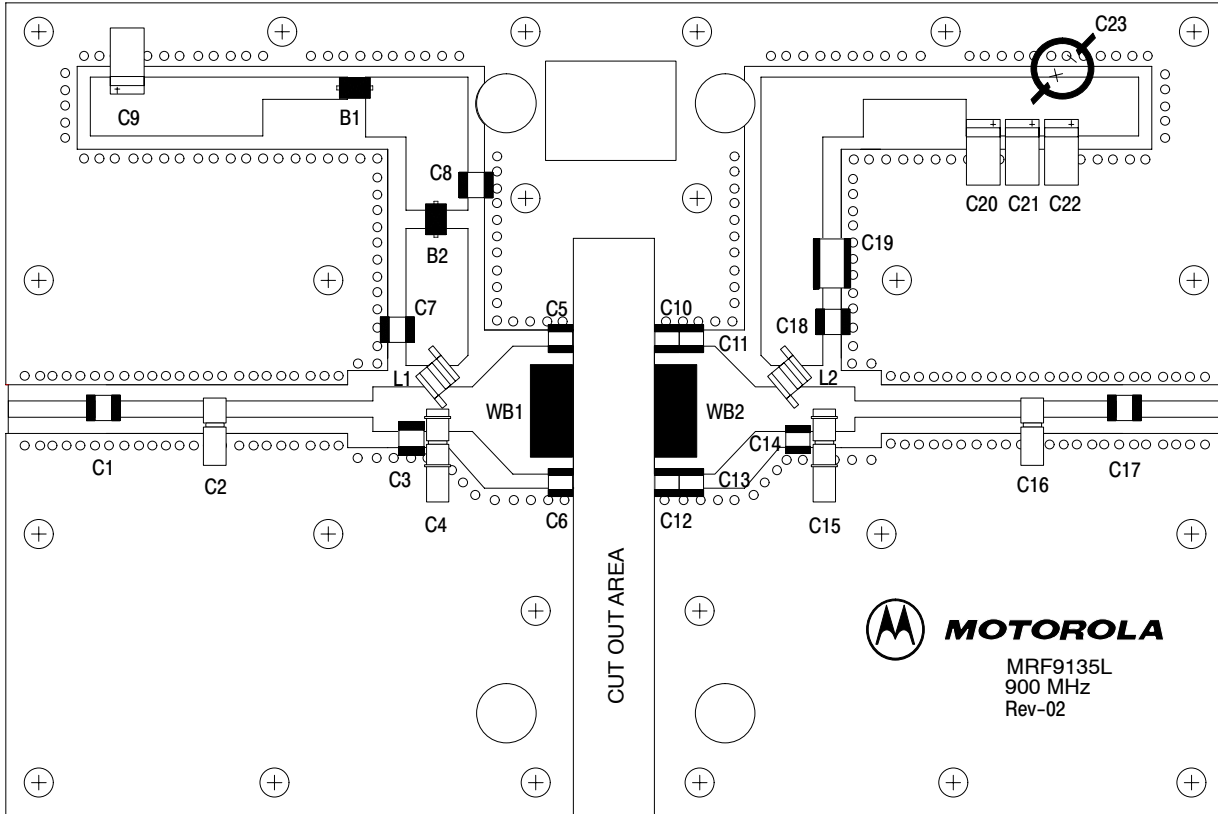

Freescal has begun the transition of marking Printed Circuit Boards (PCBs) with the Freescal Semiconductor signature/logo. PCBs may have either Motorola or Freescal markings during the transition period. These changes will have no impact on form, fit or function of the current product.

Figure 2. 880 MHz Test Circuit Component Layout

TYPICAL CHARACTERISTICS

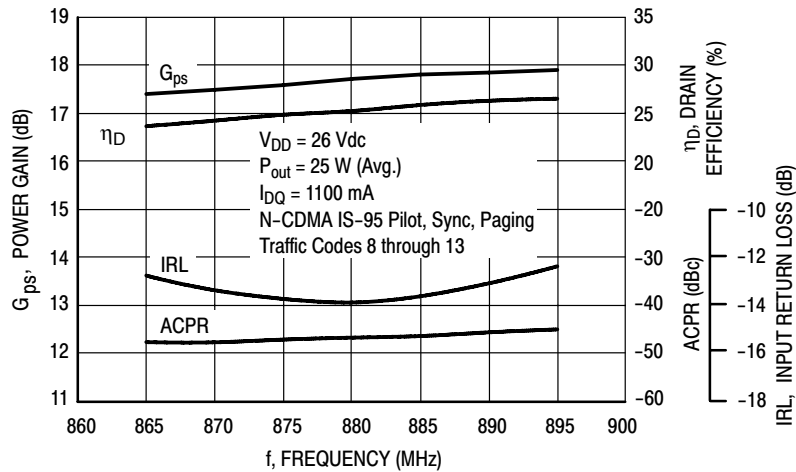

Figure 3. Class AB Broadband Circuit Performance

LIFETIME BUY

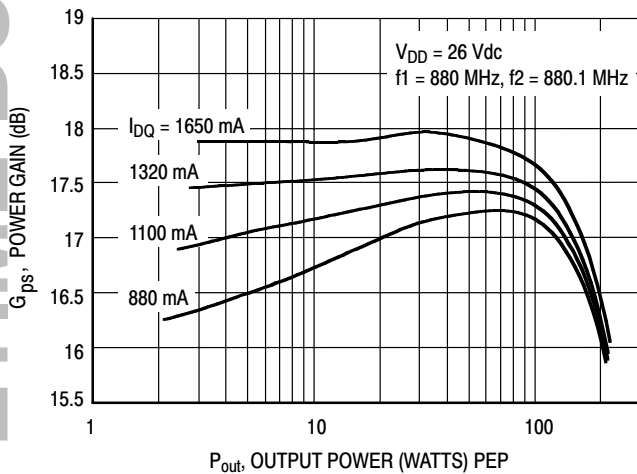

Figure 4. Power Gain versus Output Power

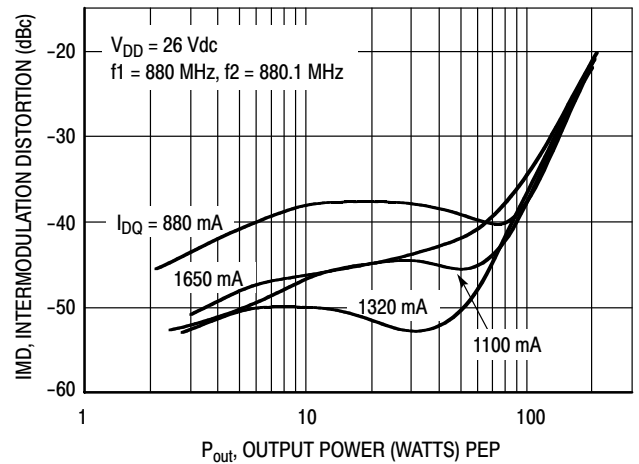

Figure 5. Intermodulation Distortion versus Output Power

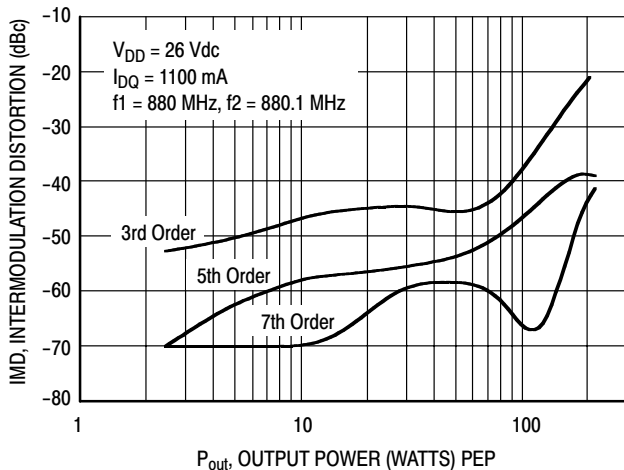

Figure 6. Intermodulation Distortion Products versus Output Power

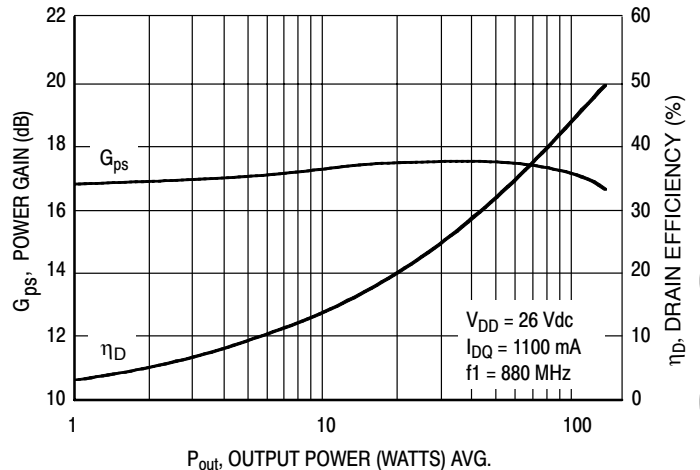

Figure 7. Power Gain and Efficiency versus Output Power

LAST ORDER 3 OCT 08 LAST SHIP 14 MAY 09

TYPICAL CHARACTERISTICS

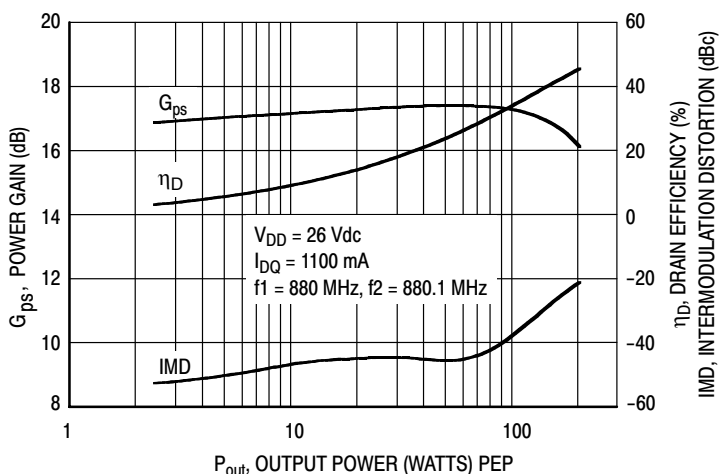

Figure 8. Power Gain, Efficiency and IMD versus Output Power

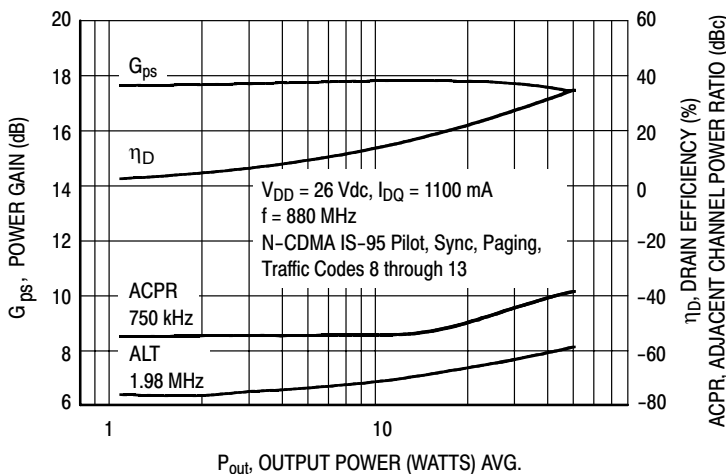
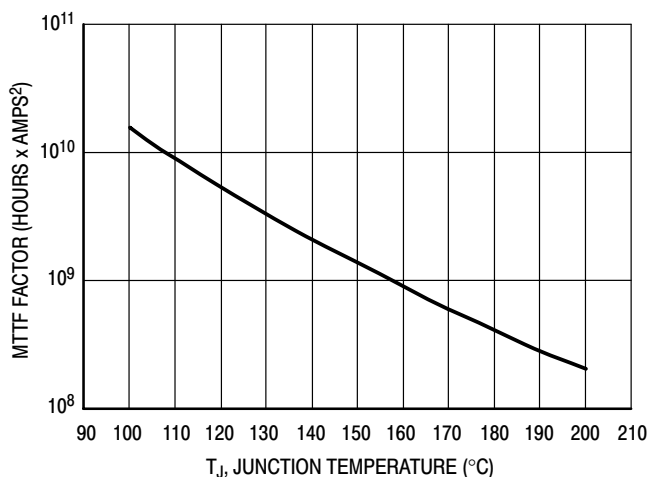

Figure 9. N-CDMA Performance Output Power versus Gain, ACPR, Efficiency



This above graph displays calculated MTTF in hours x ampere² drain current. Life tests at elevated temperatures have correlated to better than $\pm 10\%$ of the theoretical prediction for metal failure. Divide MTTF factor by I_D^2 for MTTF in a particular application.

Figure 10. MTTF Factor versus Junction Temperature

LIFETIME BUY

LAST ORDER 3 OCT 08 LAST SHIP 14 MAY 09

N-CDMA TEST SIGNAL

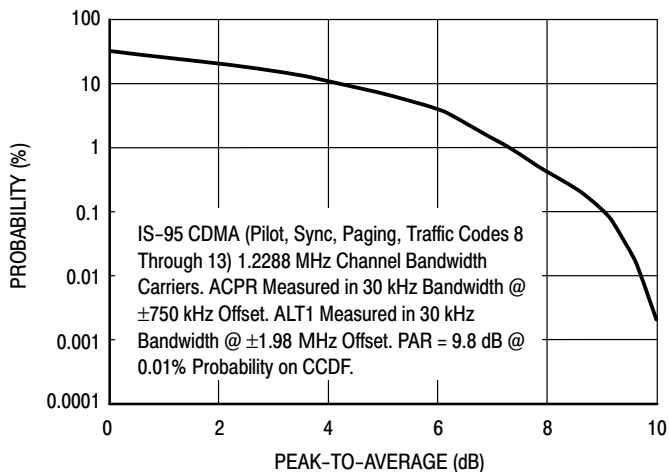

Figure 11. Single-Carrier CCDF N-CDMA

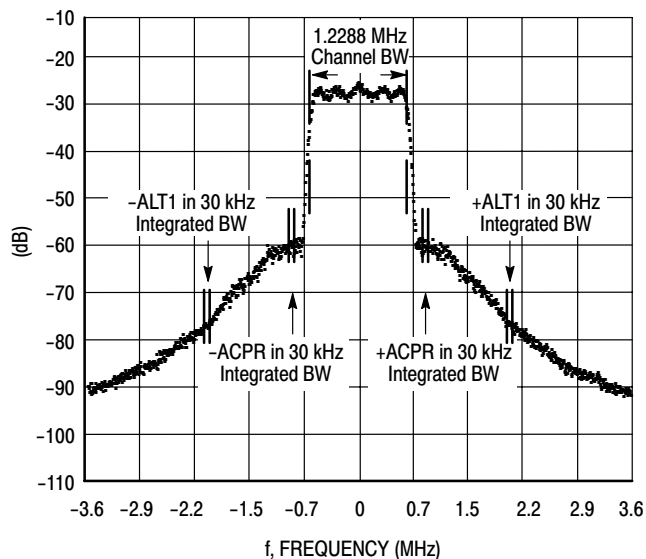
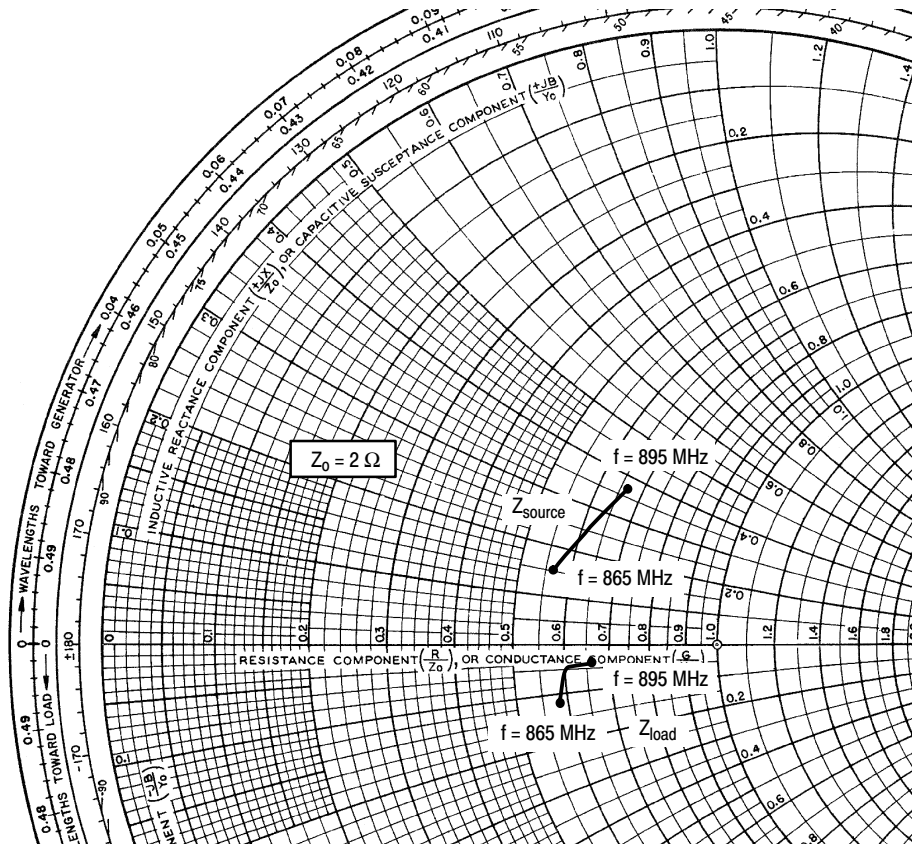

Figure 12. Single-Carrier N-CDMA Spectrum

LIFETIME BUY

LAST ORDER 3 OCT 08 LAST SHIP 14 MAY 09



$V_{DD} = 26\text{ V}$, $I_{DQ} = 1100\text{ mA}$, $P_{out} = 25\text{ W Avg.}$

f MHz	Z_{source} Ω	Z_{load} Ω
865	$1.15 + j0.3$	$1.17 - j0.24$
880	$1.25 + j0.5$	$1.22 - j0.1$
895	$1.35 + j0.75$	$1.32 - j0.07$

Z_{source} = Test circuit impedance as measured from gate to ground.

Z_{load} = Test circuit impedance as measured from drain to ground.

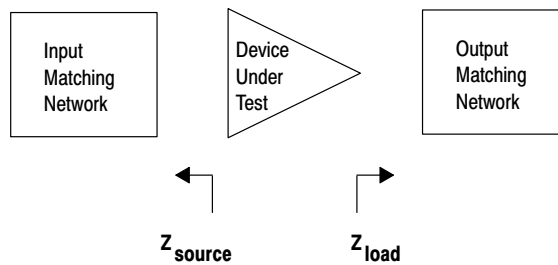
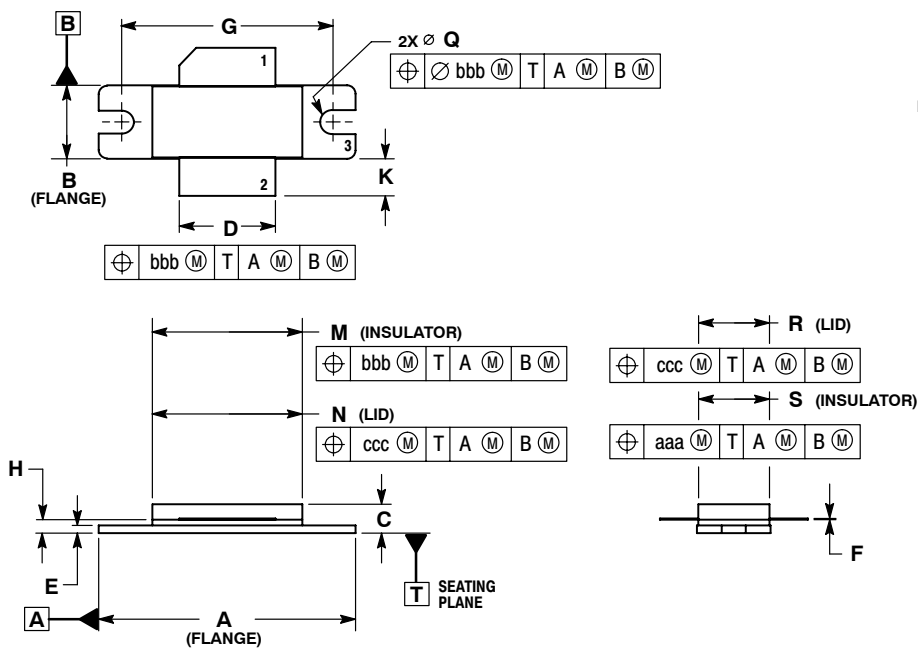

Figure 13. Series Equivalent Source and Load Impedance

PACKAGE DIMENSIONS



- NOTES:
1. DIMENSIONING AND TOLERANCING PER ANSI Y14.5M-1994.
 2. CONTROLLING DIMENSION: INCH.
 3. DELETED
 4. DIMENSION H IS MEASURED 0.030 (0.762) AWAY FROM PACKAGE BODY.

DIM	INCHES		MILLIMETERS	
	MIN	MAX	MIN	MAX
A	1.335	1.345	33.91	34.16
B	0.380	0.390	9.65	9.91
C	0.125	0.170	3.18	4.32
D	0.495	0.505	12.57	12.83
E	0.035	0.045	0.89	1.14
F	0.003	0.006	0.08	0.15
G	1.100	BSC	27.94	BSC
H	0.057	0.067	1.45	1.70
K	0.170	0.210	4.32	5.33
M	0.774	0.786	19.66	19.96
N	0.772	0.788	19.60	20.00
Q	Ø 0.118	Ø 0.138	Ø 3.00	Ø 3.51
R	0.365	0.375	9.27	9.53
S	0.365	0.375	9.27	9.52
aaa	0.005	REF	0.127	REF
bbb	0.010	REF	0.254	REF
ccc	0.015	REF	0.381	REF

STYLE 1:
 PIN 1. DRAIN
 2. GATE
 3. SOURCE

**CASE 465-06
 ISSUE G
 NI-780
 MRF9135LR3**

PRODUCT DOCUMENTATION

Refer to the following documents to aid your design process.

Application Notes

- AN1955: Thermal Measurement Methodology of RF Power Amplifiers

Engineering Bulletins

- EB212: Using Data Sheet Impedances for RF LDMOS Devices

REVISION HISTORY

The following table summarizes revisions to this document.

Revision	Date	Description
9	Sept. 2008	<ul style="list-style-type: none"> • Data sheet revised to reflect part status change, p. 1, including use of applicable overlay. • Updated Part Numbers in Table 5, Component Designations and Values, to RoHS compliant part numbers, p. 3 • Added Product Documentation and Revision History, p. 10

How to Reach Us:

Home Page:

www.freescale.com

Web Support:

<http://www.freescale.com/support>

USA/Europe or Locations Not Listed:

Freescale Semiconductor, Inc.
Technical Information Center, EL516
2100 East Elliot Road
Tempe, Arizona 85284
1-800-521-6274 or +1-480-768-2130
www.freescale.com/support

Europe, Middle East, and Africa:

Freescale Halbleiter Deutschland GmbH
Technical Information Center
Schatzbogen 7
81829 Muenchen, Germany
+44 1296 380 456 (English)
+46 8 52200080 (English)
+49 89 92103 559 (German)
+33 1 69 35 48 48 (French)
www.freescale.com/support

Japan:

Freescale Semiconductor Japan Ltd.
Headquarters
ARCO Tower 15F
1-8-1, Shimo-Meguro, Meguro-ku,
Tokyo 153-0064
Japan
0120 191014 or +81 3 5437 9125
support.japan@freescale.com

Asia/Pacific:

Freescale Semiconductor China Ltd.
Exchange Building 23F
No. 118 Jianguo Road
Chaoyang District
Beijing 100022
China
+86 10 5879 8000
support.asia@freescale.com

For Literature Requests Only:

Freescale Semiconductor Literature Distribution Center
P.O. Box 5405
Denver, Colorado 80217
1-800-441-2447 or +1-303-675-2140
Fax: +1-303-675-2150
LDCForFreescaleSemiconductor@hibbertgroup.com

Information in this document is provided solely to enable system and software implementers to use Freescale Semiconductor products. There are no express or implied copyright licenses granted hereunder to design or fabricate any integrated circuits or integrated circuits based on the information in this document.

Freescale Semiconductor reserves the right to make changes without further notice to any products herein. Freescale Semiconductor makes no warranty, representation or guarantee regarding the suitability of its products for any particular purpose, nor does Freescale Semiconductor assume any liability arising out of the application or use of any product or circuit, and specifically disclaims any and all liability, including without limitation consequential or incidental damages. "Typical" parameters that may be provided in Freescale Semiconductor data sheets and/or specifications can and do vary in different applications and actual performance may vary over time. All operating parameters, including "Typicals", must be validated for each customer application by customer's technical experts. Freescale Semiconductor does not convey any license under its patent rights nor the rights of others. Freescale Semiconductor products are not designed, intended, or authorized for use as components in systems intended for surgical implant into the body, or other applications intended to support or sustain life, or for any other application in which the failure of the Freescale Semiconductor product could create a situation where personal injury or death may occur. Should Buyer purchase or use Freescale Semiconductor products for any such unintended or unauthorized application, Buyer shall indemnify and hold Freescale Semiconductor and its officers, employees, subsidiaries, affiliates, and distributors harmless against all claims, costs, damages, and expenses, and reasonable attorney fees arising out of, directly or indirectly, any claim of personal injury or death associated with such unintended or unauthorized use, even if such claim alleges that Freescale Semiconductor was negligent regarding the design or manufacture of the part.

Freescale™ and the Freescale logo are trademarks of Freescale Semiconductor, Inc. All other product or service names are the property of their respective owners.

© Freescale Semiconductor, Inc. 2008. All rights reserved.